



This is a digital copy of a book that was preserved for generations on library shelves before it was carefully scanned by Google as part of a project to make the world's books discoverable online.

It has survived long enough for the copyright to expire and the book to enter the public domain. A public domain book is one that was never subject to copyright or whose legal copyright term has expired. Whether a book is in the public domain may vary country to country. Public domain books are our gateways to the past, representing a wealth of history, culture and knowledge that's often difficult to discover.

Marks, notations and other marginalia present in the original volume will appear in this file - a reminder of this book's long journey from the publisher to a library and finally to you.

### **Usage guidelines**

Google is proud to partner with libraries to digitize public domain materials and make them widely accessible. Public domain books belong to the public and we are merely their custodians. Nevertheless, this work is expensive, so in order to keep providing this resource, we have taken steps to prevent abuse by commercial parties, including placing technical restrictions on automated querying.

We also ask that you:

- + *Make non-commercial use of the files* We designed Google Book Search for use by individuals, and we request that you use these files for personal, non-commercial purposes.
- + *Refrain from automated querying* Do not send automated queries of any sort to Google's system: If you are conducting research on machine translation, optical character recognition or other areas where access to a large amount of text is helpful, please contact us. We encourage the use of public domain materials for these purposes and may be able to help.
- + *Maintain attribution* The Google "watermark" you see on each file is essential for informing people about this project and helping them find additional materials through Google Book Search. Please do not remove it.
- + *Keep it legal* Whatever your use, remember that you are responsible for ensuring that what you are doing is legal. Do not assume that just because we believe a book is in the public domain for users in the United States, that the work is also in the public domain for users in other countries. Whether a book is still in copyright varies from country to country, and we can't offer guidance on whether any specific use of any specific book is allowed. Please do not assume that a book's appearance in Google Book Search means it can be used in any manner anywhere in the world. Copyright infringement liability can be quite severe.

### **About Google Book Search**

Google's mission is to organize the world's information and to make it universally accessible and useful. Google Book Search helps readers discover the world's books while helping authors and publishers reach new audiences. You can search through the full text of this book on the web at <http://books.google.com/>

CS  
410  
H28  
V. 4

B 820,137



Kerchevall of Orson.	Rosse of Snenton.
Lacock of Woodborough.	Sacheverell of Barton.
Lascells of Elston.	Salmon of Finningley.
Lee of Norwell.	Savile of Rufford.
Leeke of Balderton.	Savile of Oxton.
Leeke of Hallum.	Savile of Darton Grange.
Mansfeild of Westleak.	Scroope of Langar.
Markham of Ollerton.	Sherbroke of Oxton.
Mellish of Ragnall.	Shipman of Scarrington.
Midleton of Wannesley.	Smith of Askham.
Molineux of Teversall.	Stanhope of Stoke juxta Nottingham.
Molineux of Little Markham.	Staunton of Staunton.
More of Kirtlington.	Stertevant of Norwell.
Mucklow of Broughton on Soulney.	Strelley of Woodborough.
Mompesson of Bilsthorpe.	Stringer of Sutton upon Lound.
Needham of Kynolton.	St. Andrew of Gotham.
Odingsells of Eperston.	Tate of Sutton Bonington.
Palmer of Southwell.	Thornhagh of Fenton.
Palmes of Stapleford.	Thoroton of Carcolston.
Parkins of Bonney.	Tonstall of Everton.
Pendock of Tollerton.	Waldron of East Bridgford.
Pierpont of Nottingham.	Warburton of Rolles.
Pierpont of Thorsby.	Wastneys of Hedon.
Pigot of Thrumpton.	Whalley of Kirton.
Plumptre of Nottingham.	Whalley of Cotgrave.
Rayner of East Drayton.	Widmerpole of Widmerpole.
Rodes of Sturton.	Williamson of Great Markham.
Rolleston of Watnall.	Willoughby of Selston.
Roos of Laxton.	Wood of Woodborough.
Rosell of Ratcliffe upon Sore.	Wylde of Nettleworth.

I need only add that my best thanks are due to John Davidson, Esq., for undertaking the labour of compiling the complete and comprehensive index to this work.

65  
8/1  
1120

1120



THE  
PUBLICATIONS  
OF  
**The Harleian Society.**

ESTABLISHED A.D. MDCCCLXIX.



**Volume IV.**

FOR THE YEAR MDCCCLXXI.

TAYLOR AND CO., PRINTERS,  
LITTLE QUEEN STREET, LINCOLN'S INN FIELDS.

*Henry Lea*  
**The Visitations of the County of  
Nottingham**

**In the Years**

**1569 AND 1614,**

WITH

**MANY OTHER DESCENTS OF THE SAME COUNTY.**

EDITED BY

**GEORGE WILLIAM MARSHALL, LL.M.**

**LONDON :**

**1871.**



*At a Meeting of the Council of the HARLEIAN SOCIETY, held at 8, Danes Inn, London, W.C., on the 16th day of March, 1871, the HON. HENRY ROPE-CURZON in the Chair, it was resolved that—*

*“The VISITATION OF NOTTINGHAM IN 1569 AND 1614, to be edited by G. W. MARSHALL, be the Second Publication for the Present Year.”*

## Preface.

---

THE following pages are a copy of Harleian MS. 1555, together with such additions as can be supplied by collating it with Harl. MS. 1400. Harleian MS. 1555 was for the most part written and tricked by Richard Mundy, and contains the Visitations of Nottinghamshire made in 1569 and 1614. Harleian MS. 1400 contains professedly the Visitation of 1614; was partly written by John Withie, but mostly by Jacob Chaloner and others. The pedigrees in this MS. are far less complete than those in the former, nevertheless they have enabled me to add considerably to many of them. Taking Harleian MS. 1555 as the copy to be edited, I have added to the pedigrees it contains every scrap of additional information furnished by Harleian MS. 1400; and whenever the MSS. differ in the names of persons, places, or blazon of arms, I have given the different reading, and appended the words "Harl. 1400" in parentheses. It may not be thought unnecessary to say a few words in justification of this course. When I undertook to edit for the Harleian Society the Visitation of Nottinghamshire taken in the year 1614, I was not aware that it would be impossible to separate it from that of 1569, but having afterwards come to this conclusion on a closer examination of the Harleian MSS. containing Visitations of Nottinghamshire, I determined to solve the difficulty by producing both. Undoubtedly the best copy of them is that in Harleian MS. 1555, which forms the staple of this work, but the supplementary matter to be gathered from Harleian MS. 1400 appeared to me to be too valuable to be omitted, and, at the same time, that MS. does not differ so much from the former that its contents would be worth producing as a separate volume. I hope therefore that by incorporating the two, I shall be deemed to have done most service to the members of the Harleian Society.

The first Visitation of Nottinghamshire, if the few pedigrees recorded in Tonge's Visitation of the northern counties are worthy to be considered as such, was taken in the year 1530, and has been printed in the 41st volume of the publications of the Surtees Society.

## Stanhop.

**ARMS.** Quarterly:—1. Quarterly, ermine and gules. 2. Vert, three greyhounds courant or. 3. Sable, a bend between six cross crosslets argent. 4. Argent, three saltires engrailed sable, a crescent for difference gules.

**CREST.** Out of a tower azure a demi lion or, crowned gules, and holding between his paws a flint-stone proper.

This coat also accompanies the Stanhope pedigree:—

**Quarterly:—**1 and 18. Quarterly, ermine and gules. 2. Vert, three greyhounds courant or. 3. Sable, a bend between six cross crosslets argent. 4. Argent, on a cross patonce azure, five escallops or. 5. Argent, a cross patonce azure. 6. Argent, three saltires engrailed sable, a crescent for difference gules. 7. Azure, a fess engrailed between three birds, holding in their beaks cross crosslets fitched or. 8. Argent, a chief vairé or and gules, a bend sable. 9. Or, an eagle displayed azure, beaked and clawed gules. 10. Ermine, a bordure gules, semée of horse-shoes or. 11. Sable, a bend engrailed between six billets argent. 12. Gules, three covered cups argent. 13. Azure, six martlets or, a canton ermine. 14. Per fess sable and argent, a pale and three griffins' heads, all counterchanged. 15. Argent, pretty sable, a canton of the last. 16. Gules, a chevron between three wolves' heads erased argent. 17. Gules, a chevron between three lions passant guardant or.

Thomas de Longvillers de Houghton in Com. Nottingham fl. Joh'is de Longvillers d'ni Manerii de Tuxford per inquis. iv. E. 8

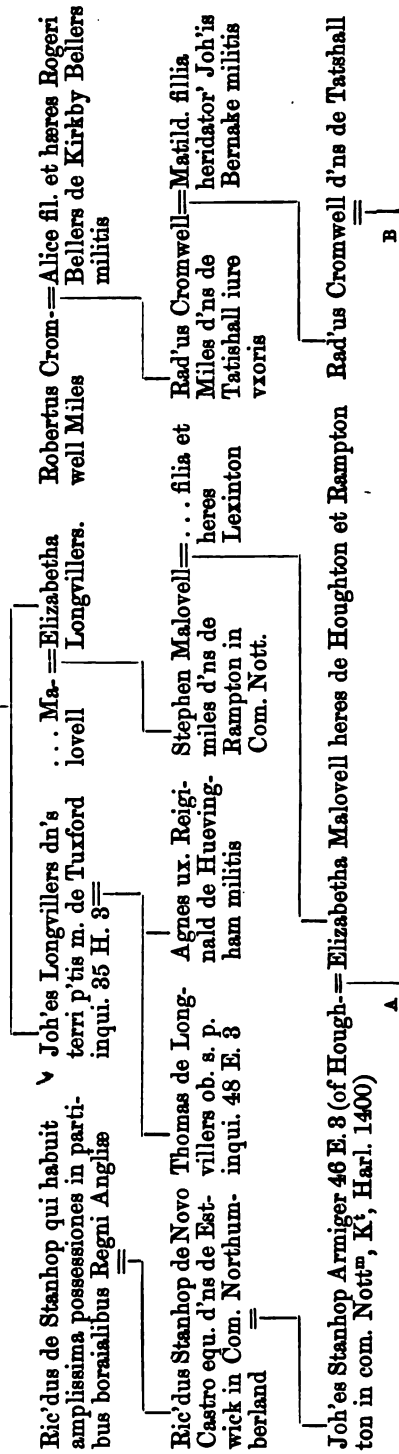



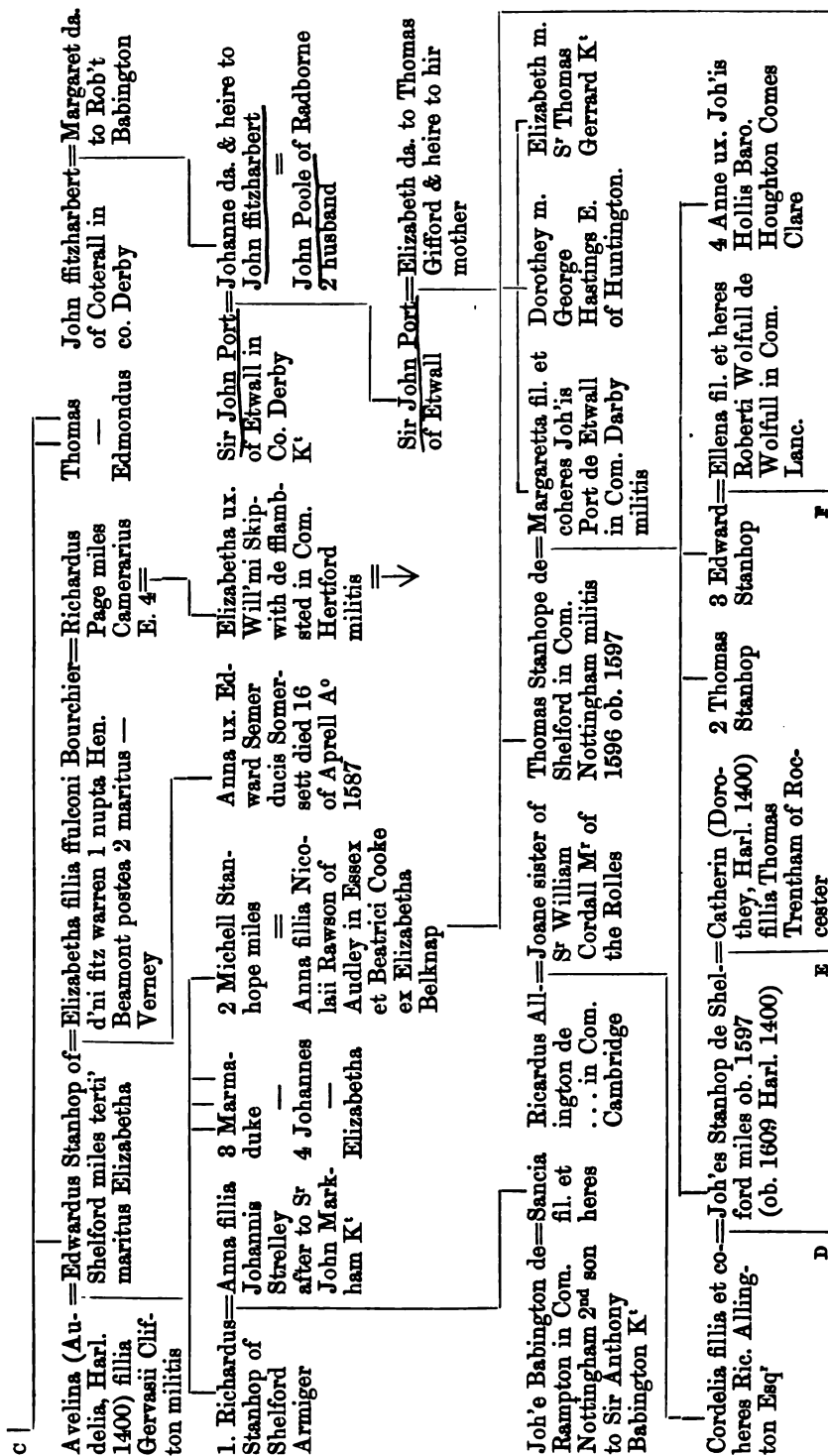

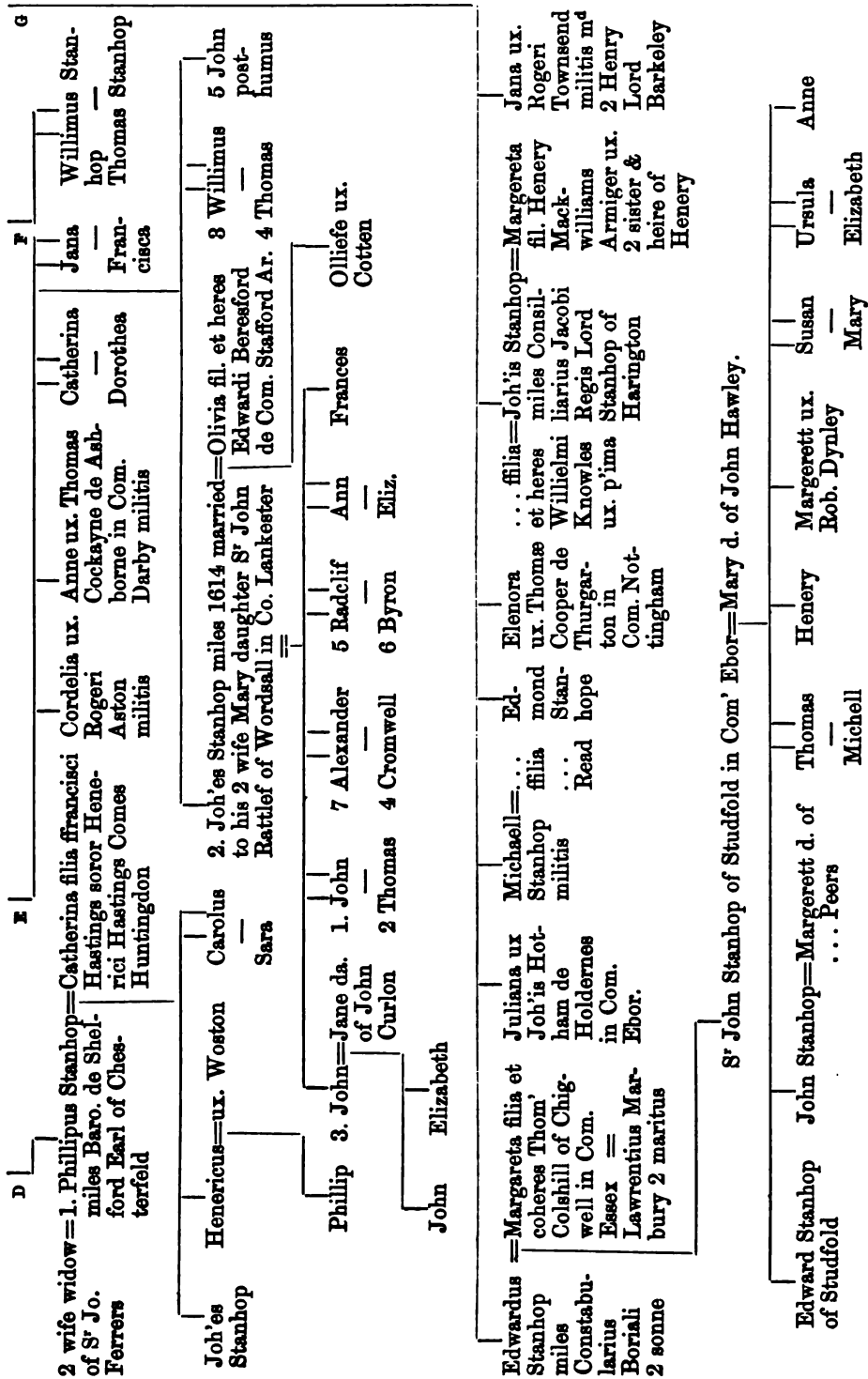

# Byron.

ARMS. Quarterly:—1 and 4. *Argent, three bendlets enhanced gules.* BYRON. 2. *Argent, on a bend azure three annulets or, in sinister chief a cross crosslet fitché sable.* CLAYTON. 3. *Gules, three fusils conjoined in fess argenti, in chief two cinquefoils pierced or.* COLWICK. CREST. *A mermaid proper, crined and holding in her dexter hand a mirror and in her sinister a comb or.*

The above coat, differenced with a bordure sable, is also tricked with this note:—"Thus John Biron of Newsted, base sonn of Sr John bare it, and two descents from him." Under the trick of the undifferenced coat is written, "Thus they bear it now, 1630."

Sir Richard Byron of Byron & Clayton in Com. Lanck.

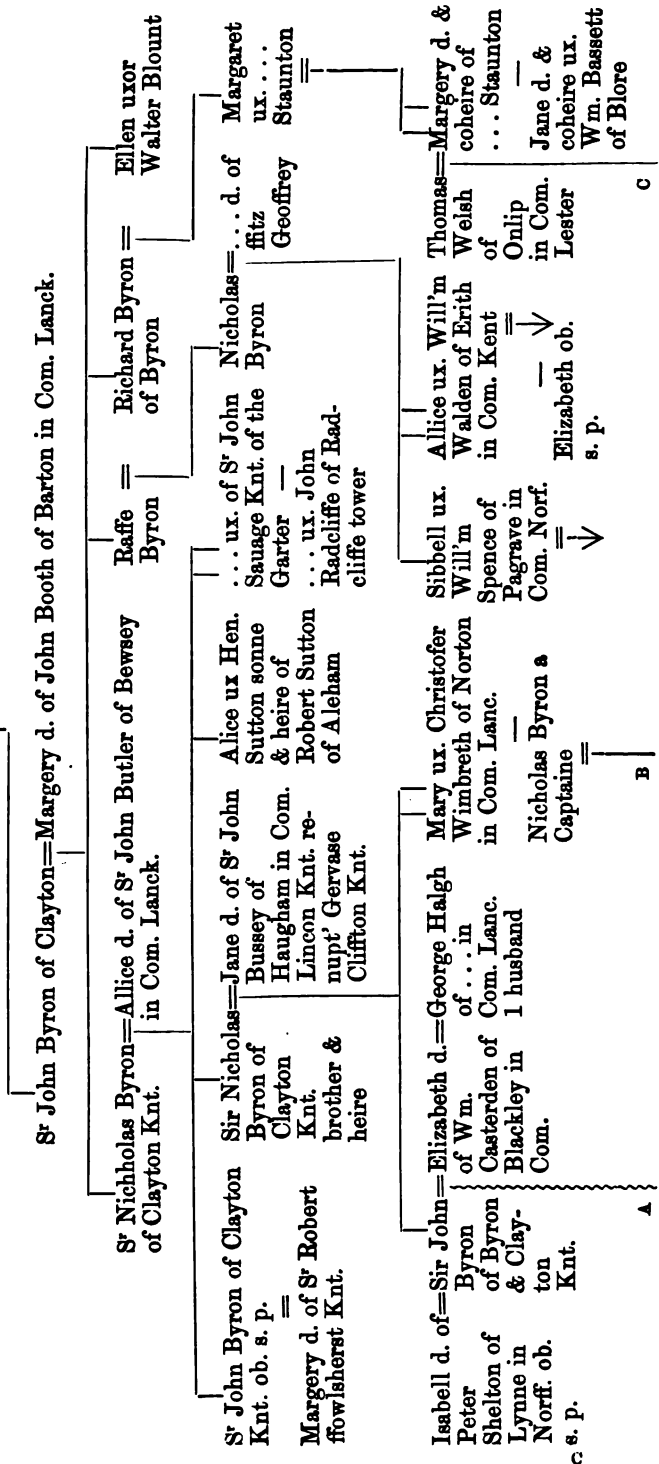

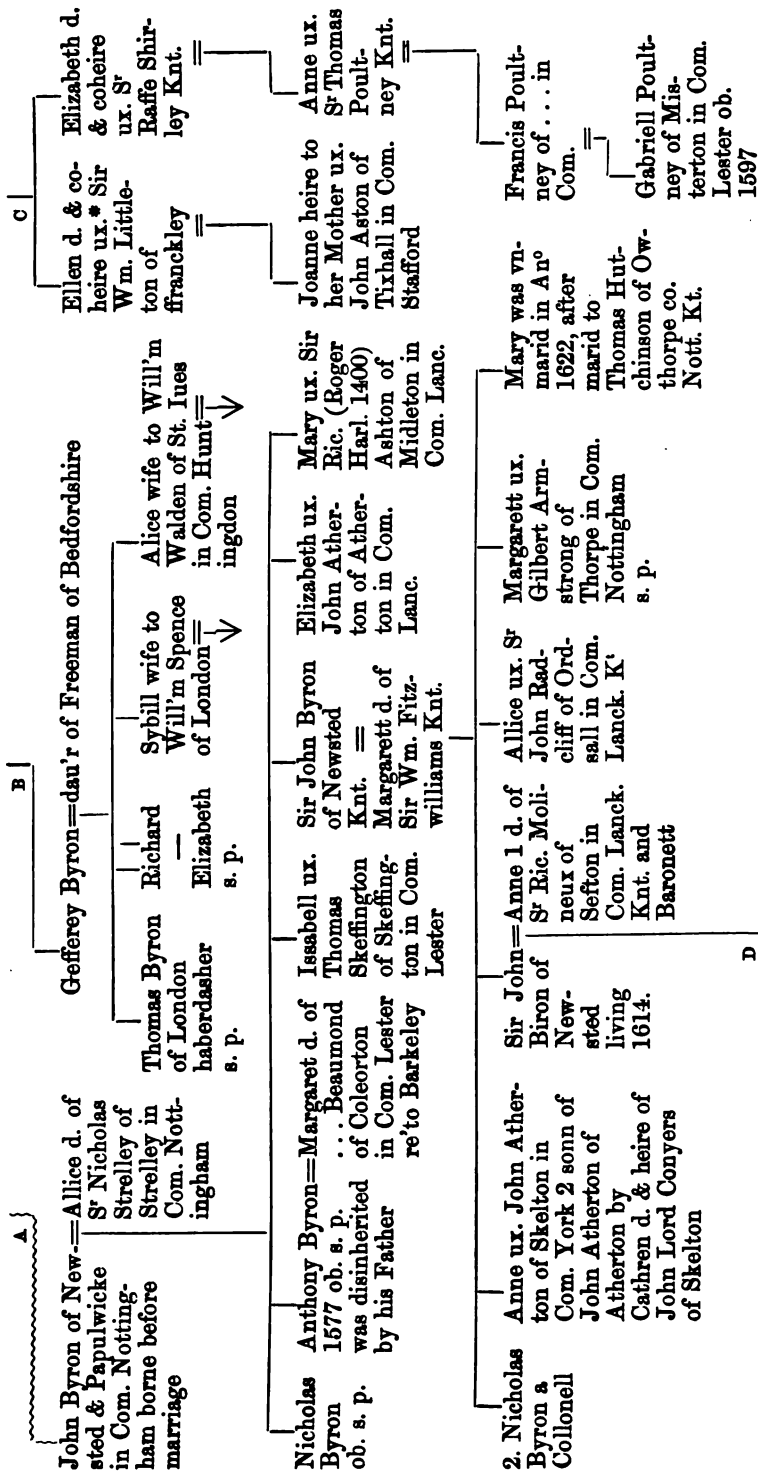

\* In Harl. MS. 1400 she is made sister to her grandmother.



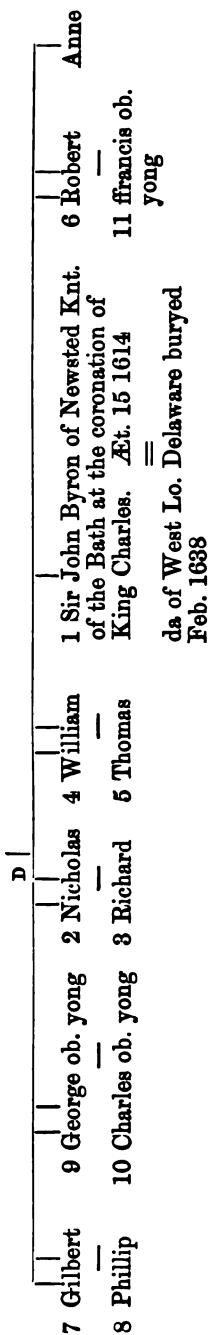

**Byrom of Byrom Hall, Lanc.**

(Harl. 1400.)

W<sup>m</sup> Byrom

John Byrom of the p'ish of Looton in Com. Lanc.

John Byrom of London=d. of

William Byrom of London=Jane da. of Tho. Chaloner of Linfeild in Com. Sussex  
Brewer

## Mering.

ARMS. *Quarterly* :—1 and 6. *Argent, on a chevron sable three escallops or.* MERING. 2. *Or, a lion rampant, double queuee vert.* SUTTON. 3. *Gules, a chief argent.* HERCYE. 4. *Ermine, a chief azure.* FITZARCHES. 5. *Argent, on a saltire engrailed sable nine annulets or.* LEEKE.  
 CREST. *A horse's head erased sable, bezanté, in the nose an annulet or.*

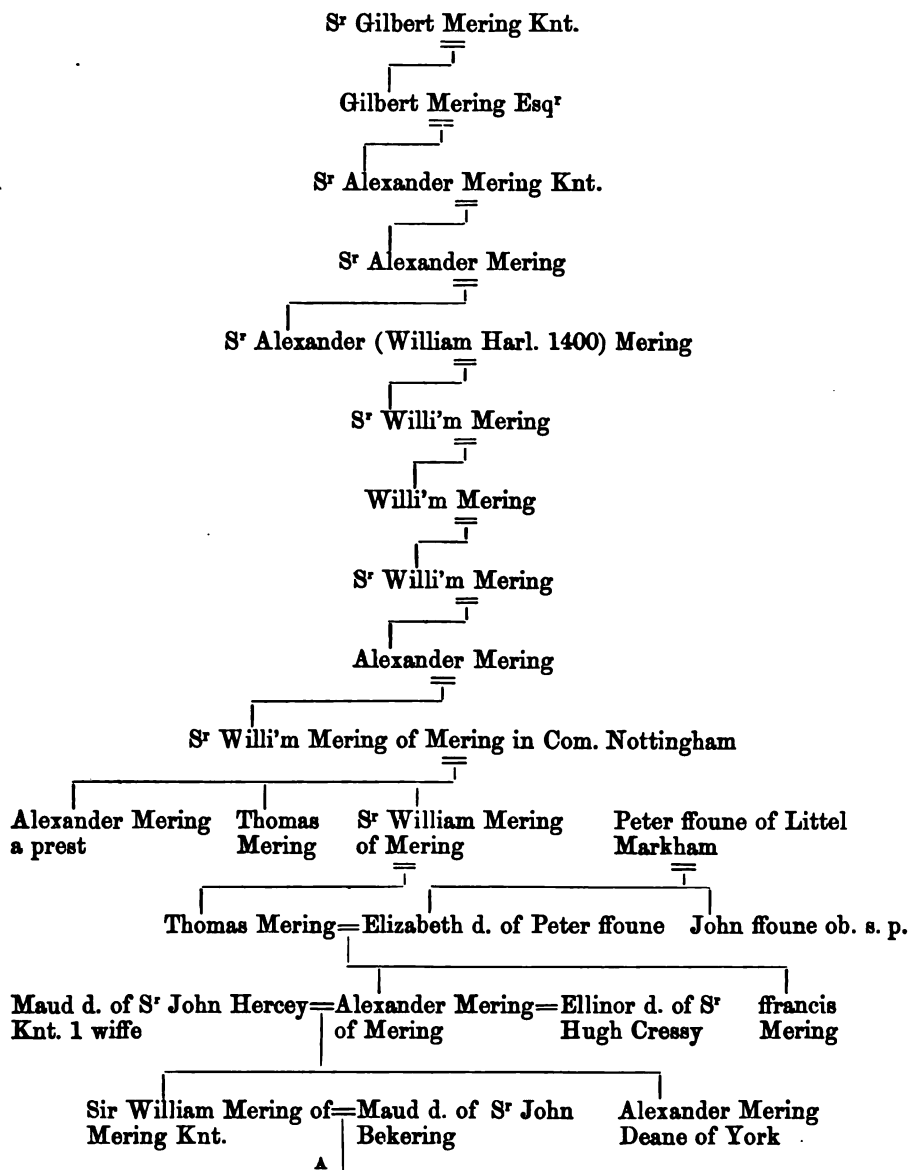

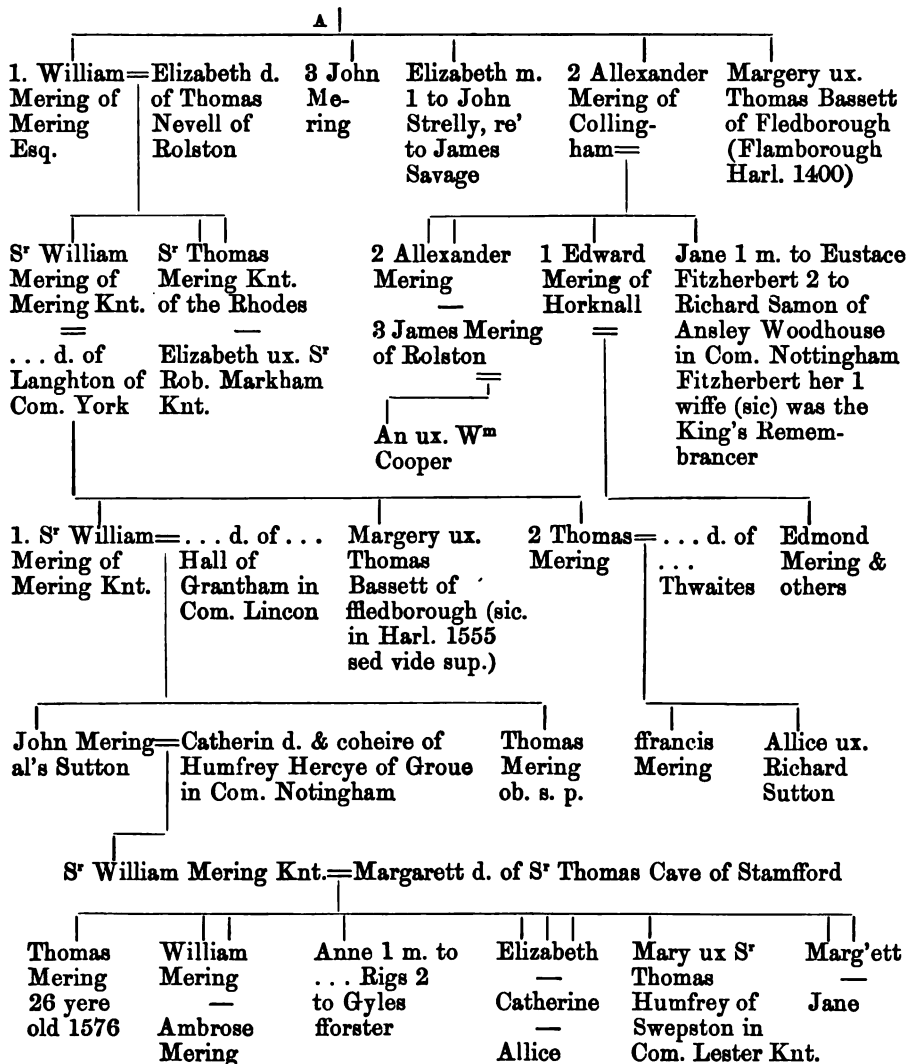

In Greate Markham Church in Com. Nottingham.

Hic iac' d'na Milicent Mering quondam uxor Willm' Mering Militis qui obiit 16 Septemb'r 1419.

1. Argent, on a chevron sable three escallops or, *impaling*, chequé gules and argent, a bend. 2. Azure, on a chief or a lion issuant gules, *impaling* same. 3. Three pilgrims' staves meeting in base gules, *impaling* same.

## Hercye.

ARMS. *Quarterly*:—1 and 6. *Gules, a chief argent.* HERCYE. 2. *Ermine, a chief azure.* ARCHES. 3. *Argent, on a saltire engrailed sable nine annulets or.* LEAKE. 4. *Sable, a tower or.* TOWERS. 5. *Argent, a chevron between three fusils sable.* STAVELEY.

CREST. *A hedgehog proper.*

Gilbert de Arches Baron of Groue nere Retford

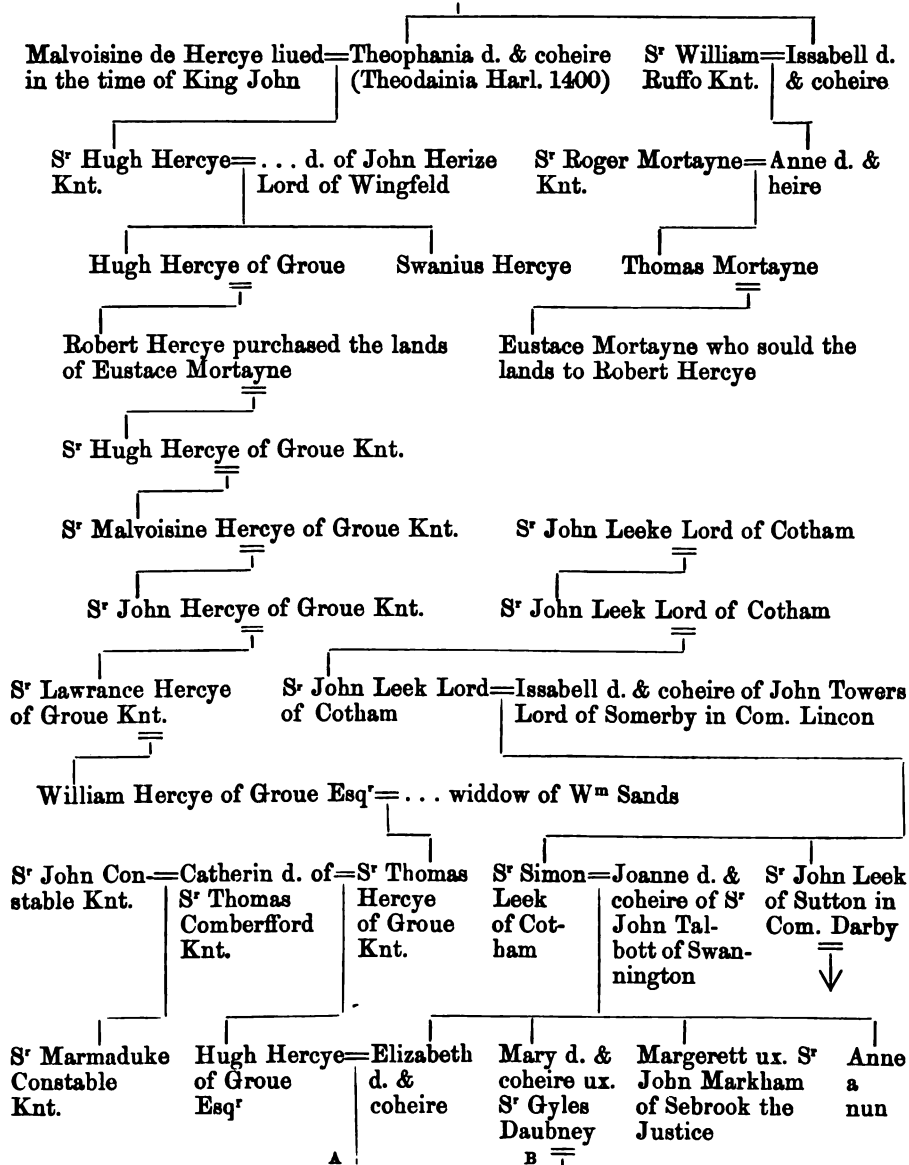

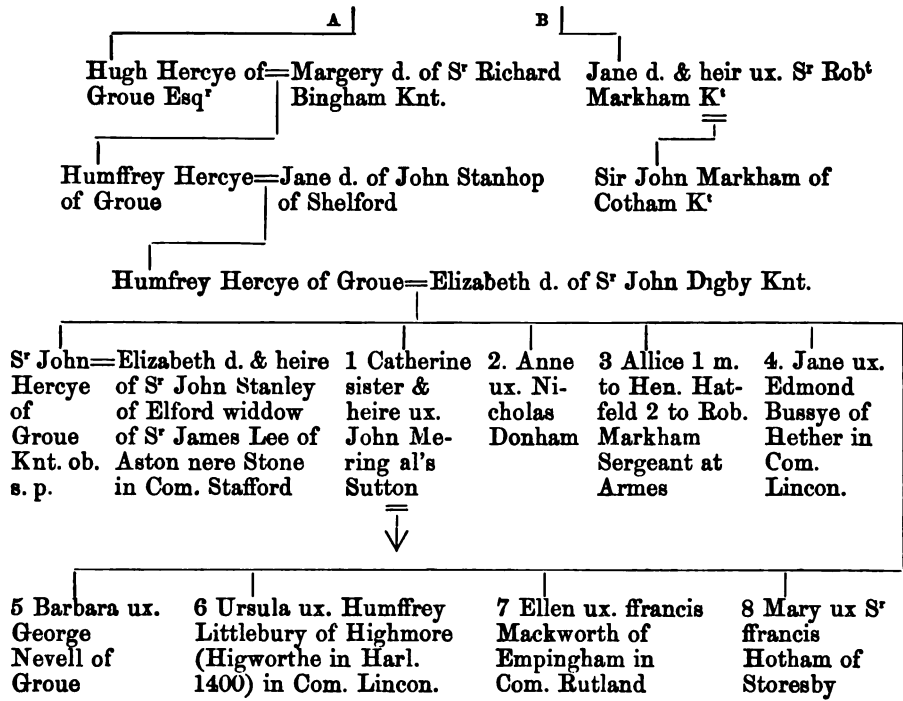



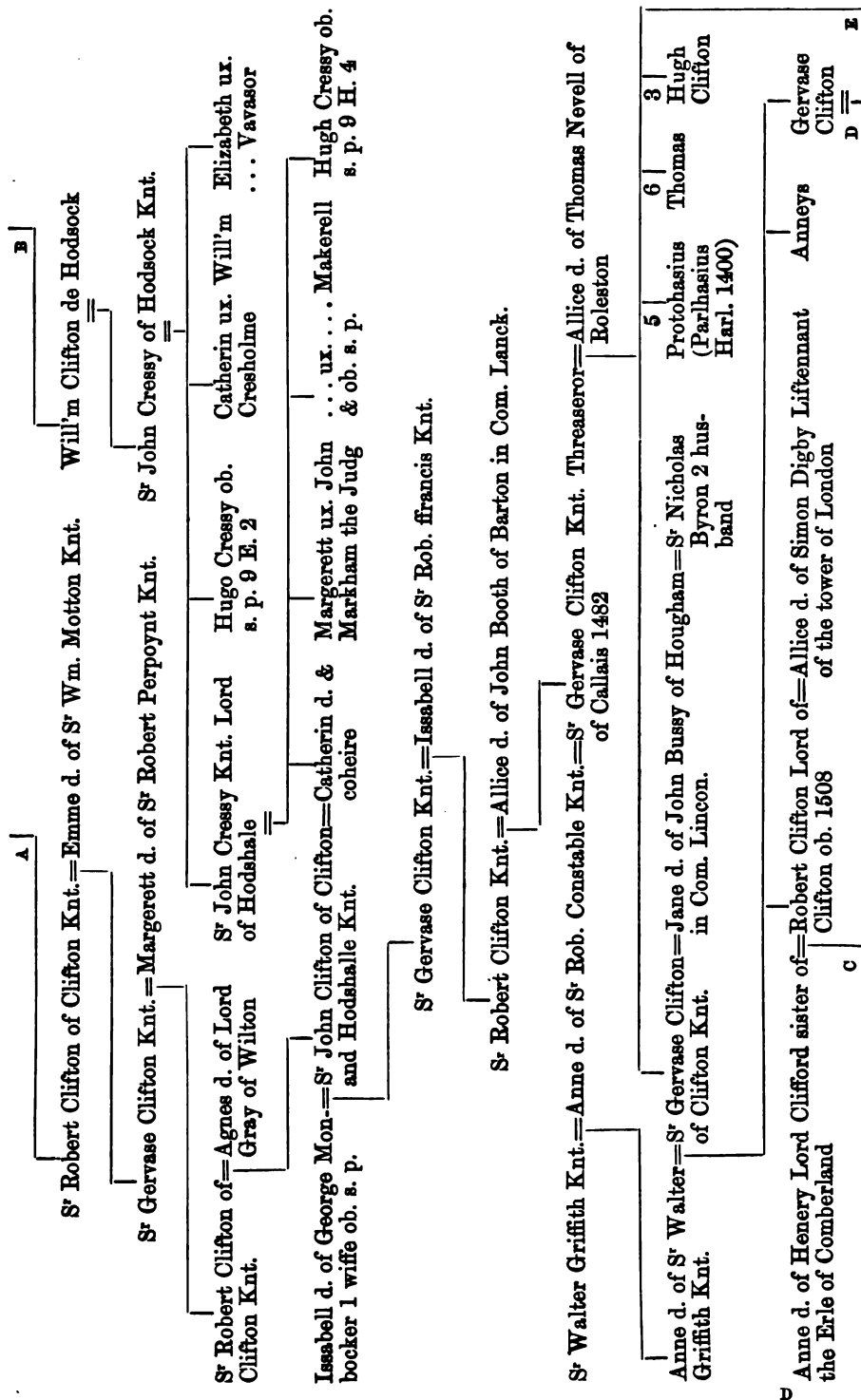

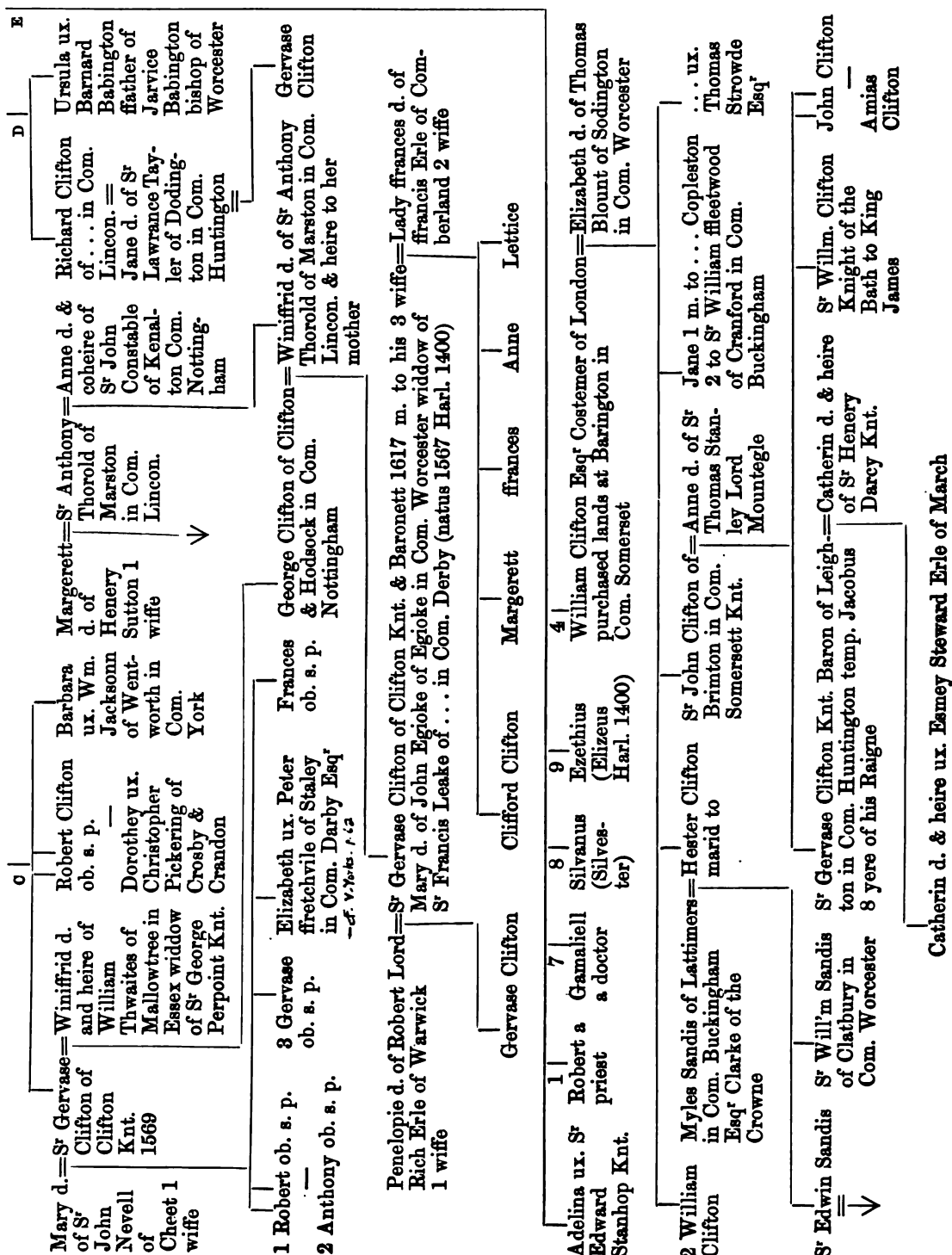



# Strelley.

## STRELLEY OF STRELLEY.

ARMS. *Quarterly*.—1 and 4. *Paly of six argent and azure.* 2. \**Or, an eagle displayed sable, beaked and membered gules.* 3. *Or, a fess dancetté sable.*

CREST. *A man's head couped at the shoulders swart, crined sable, encircled by a band gules belled or.*

## STRELLEY OF WOODBOROUGH.

ARMS. *Quarterly*.—1 and 4. *Paly of six argent and azure, a cinquefoil pierced gules.* 3 and 4. *Barry of eight argent and azure, a lion rampant or.*

CREST. *A cockatrice's head vair, beaked, combed, and wattled gules.*

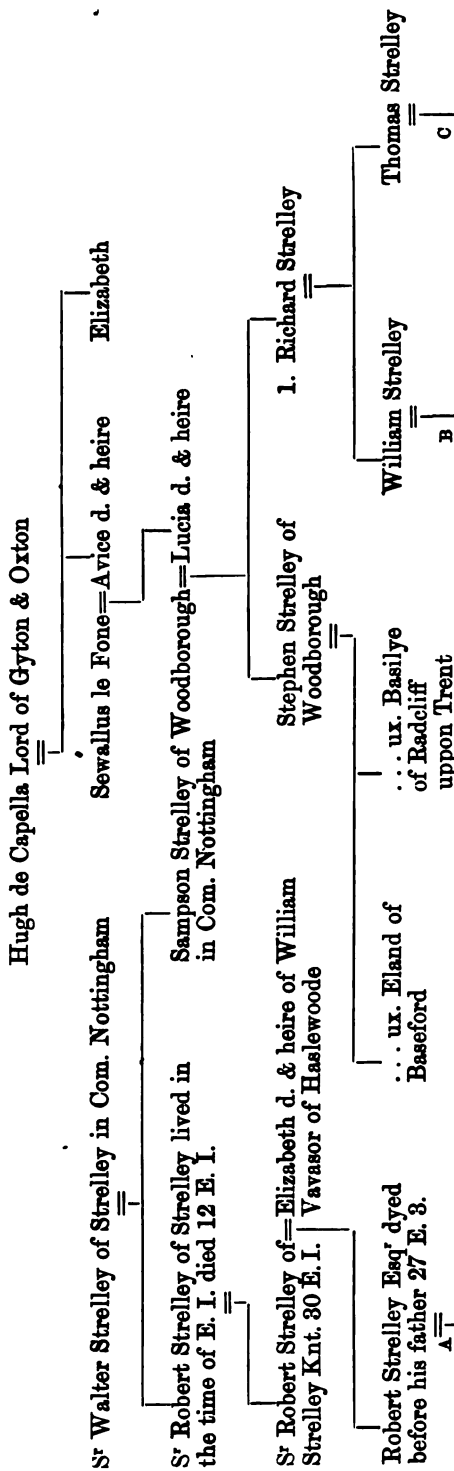

\* Argent in Harl. MS. 1400, and the whole coat has a martlet for difference.

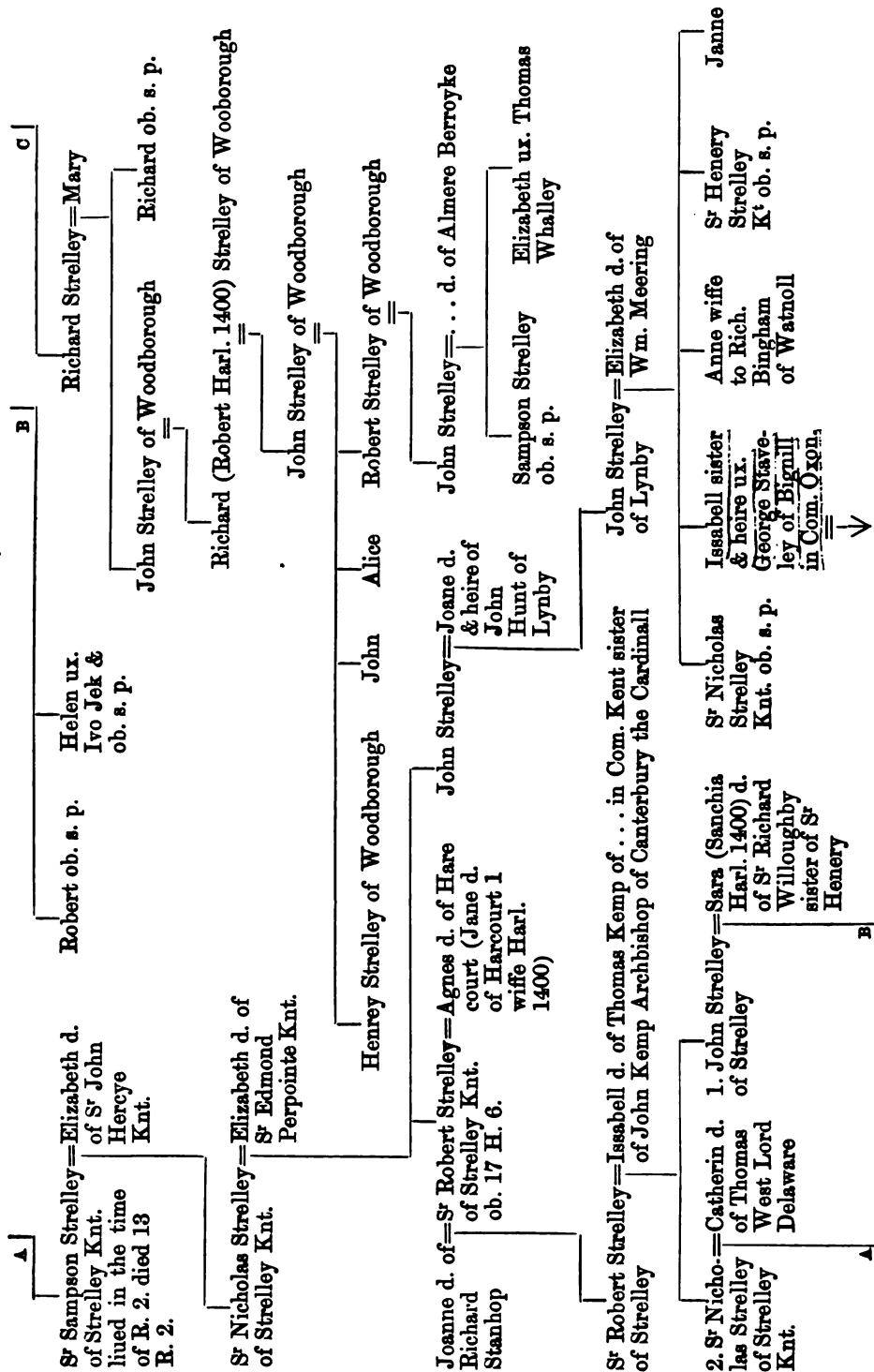

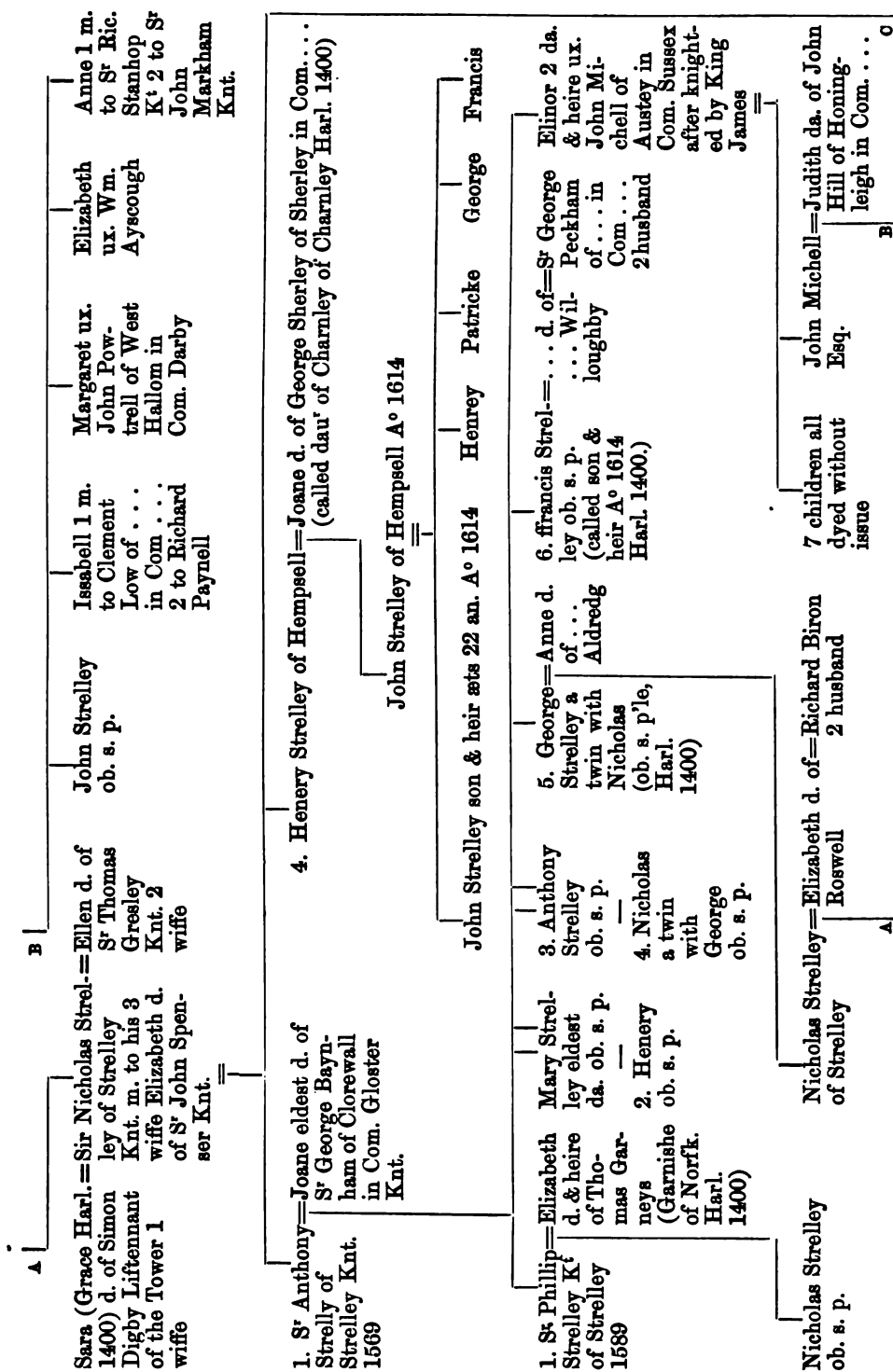

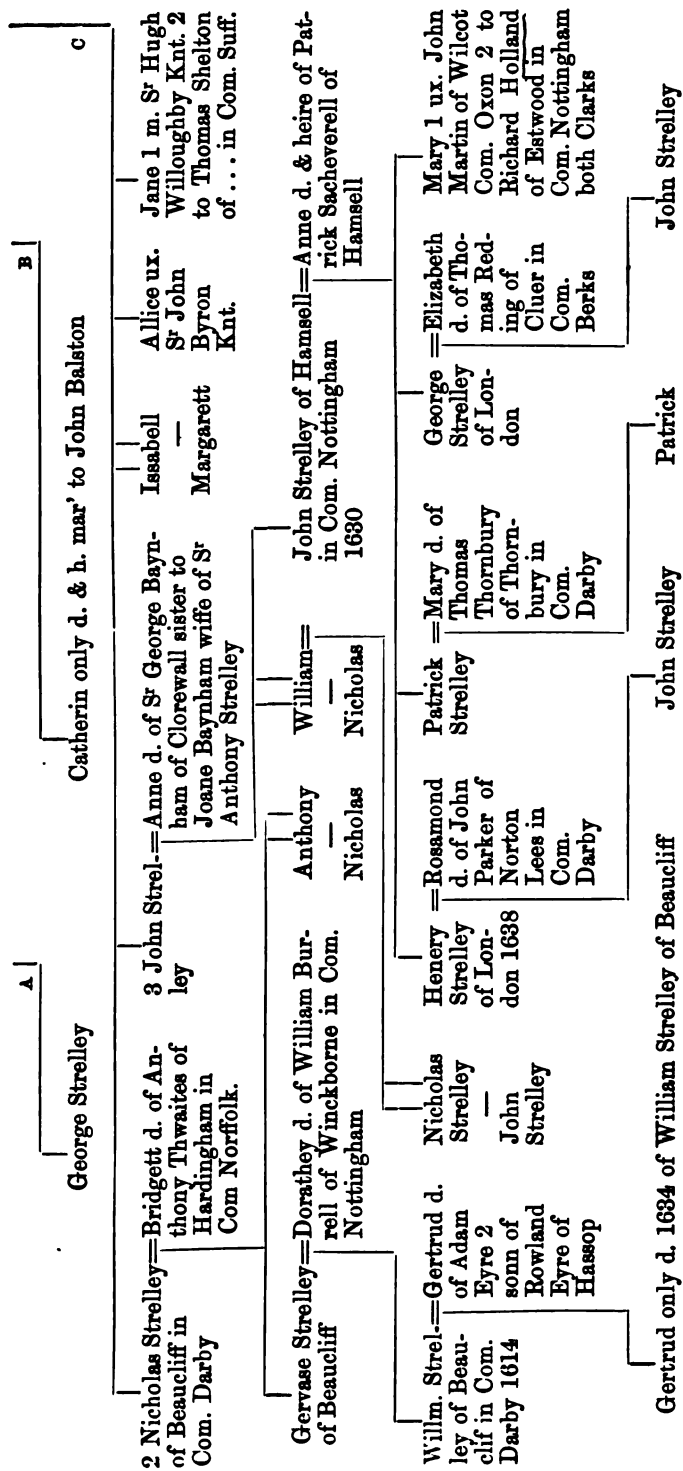

# Markham.

\* ARMS. *Quarterly*:—1. *Azure, on a chief or a lion issuant gules.* 2. *Argent, a lion rampant, double queued sable.* 3. *Argent, three pilgrims' staves gules, garnished or.* 4. *Chequé argent and gules a bend sable.* 5. *Gules, a fess fusilly argent.* 6. *Argent, on a saltire engrailed sable nine annulets or.* 7. *Sable, a tower or.* 8. *Argent, a chevron between three lozenges sable.* 9. *Argent, three fleurs-de-lis between nine cross crosslets fitchéd gules.* 10. *Gules, on a saltire argent an annulet sable.* 11. *Sable, a chevron between three trefoils argent.* 12. *France and England quarterly within a bordure compony.* 13. *Gules, a fess between six cross crosslets or.* 14. *Argent, two bars gules.* 15. *Lozengy or and azure, a bordure gules bezanté.* 16. *Chequé or and azure, a chevron ermine.* 17. *Gules, semée of cross crosslets or.* 18. *Gules, a chevron between ten crosses patée argent.* 19. *Gules, a lion passant guardant argent, crowned or.* 20. *Or, a fess between two chevrons sable.*

Sr Alexander Markham Knt. Constable of the Castell of Nottingham temp. H. 3

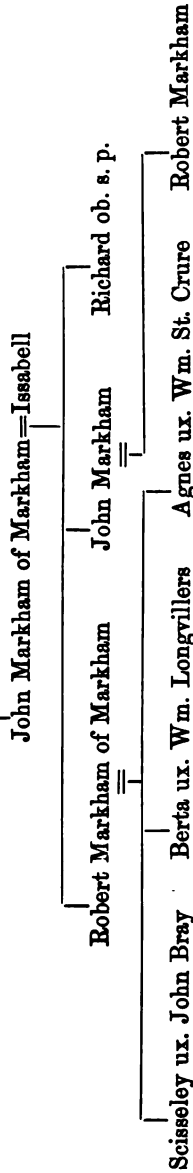

John Markham of Markham=Joane d. & heire of Sr Nicholas Bothomsell Knt.  
Or, on a bend sable three mullets argent.

Robert Markham of Markham=... of Sr John Cauntoun Knt.  
Argent, a chevron between three griffins' heads erased sable.

Margerett d. & coheire of Sr Henery=John Markham of Sedbrooke in Com.=Millesent d. & coheir of Sr John Bekereng=Sr John Margerett d. & coheire of Sr Henery  
(John Harl. 1400) Cressy Knt. ... Lord Cheefe Justice of the Comon Pleas 2 husband  
Chequé gules and argent a bend sable.  
Knt. 1 husband

\* There is a trick in the MS. of a coat containing the first nine of these quarterings with the addition in the second quarter of Argent, a cross patonce azure.  
† The word Sedbroke, i. e. Sedgebrooke, is erased in Harl. MS. 1400, and "Markham" substituted.

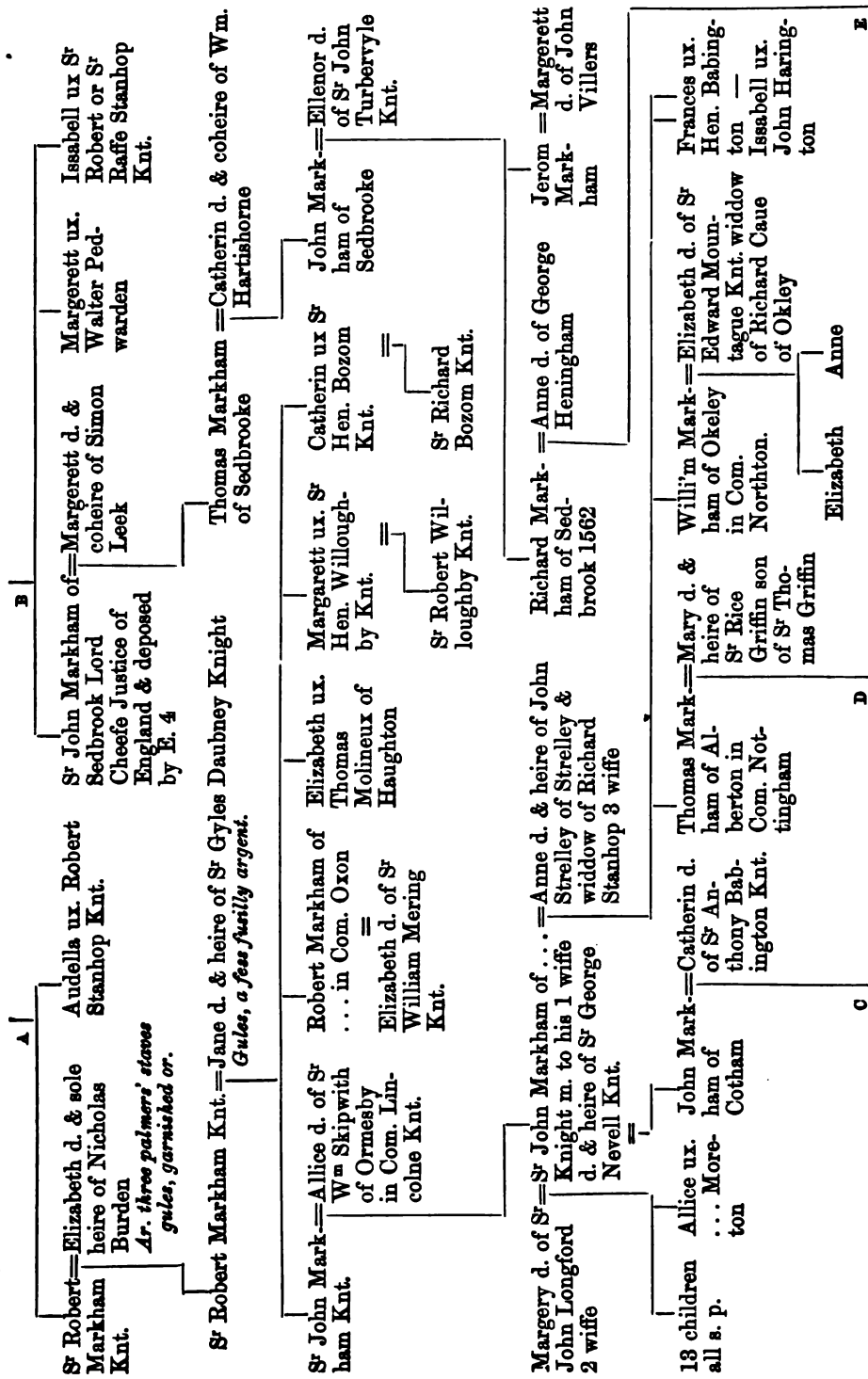

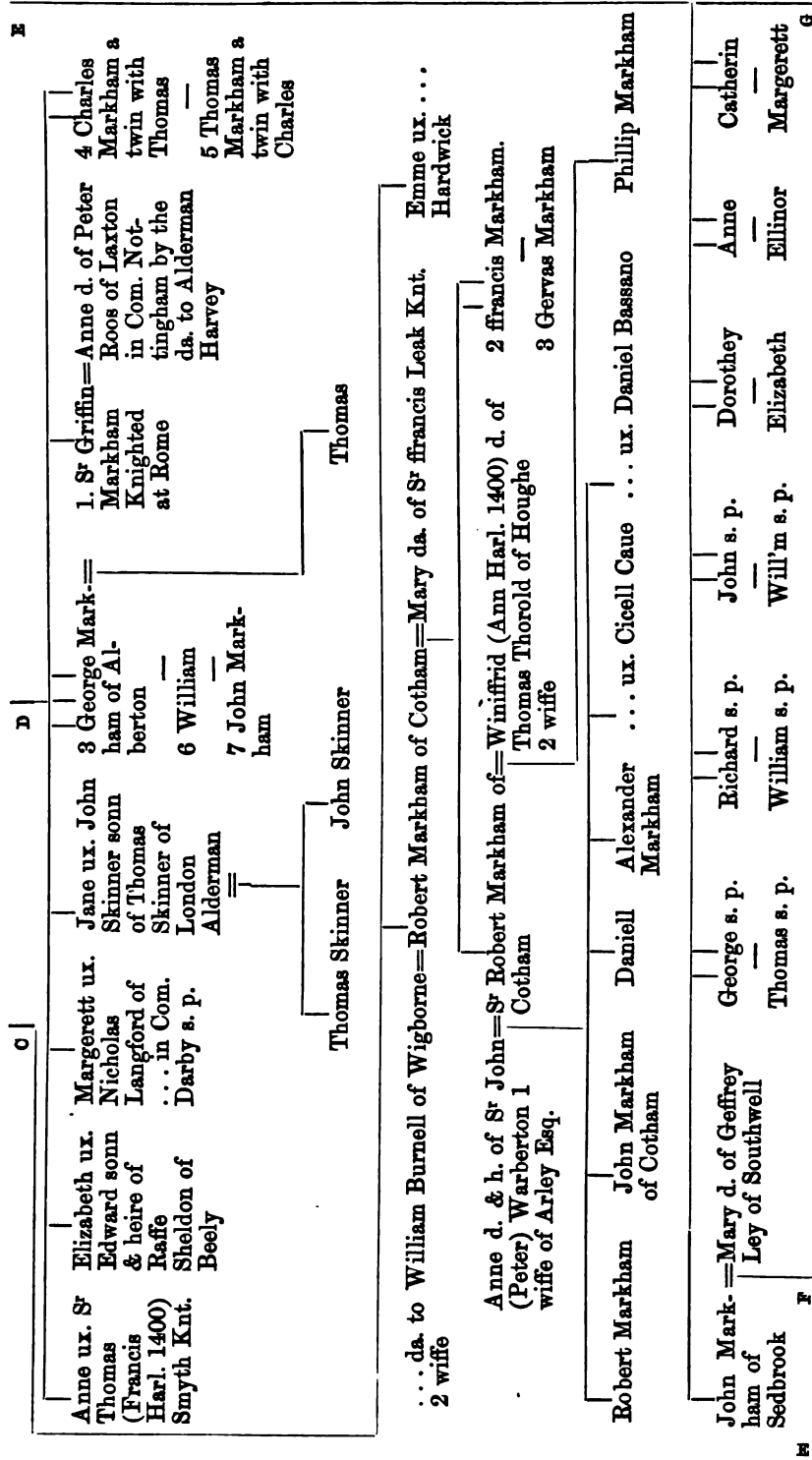

e

d

c

f

g

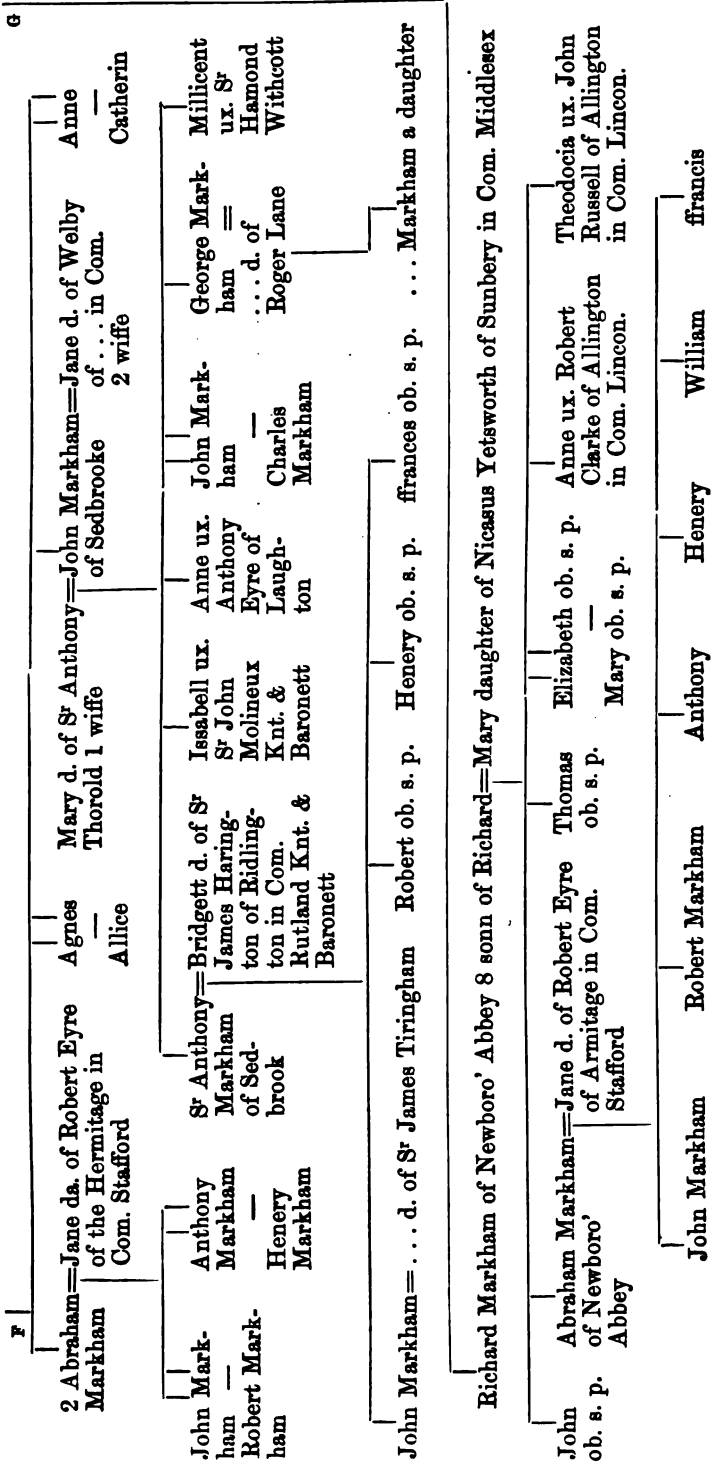



**Poole.**

ARMS. *Quarterly:—1 and 4. Azure, a lion rampant argent between eight fleurs-de-lis or. 2. Gules, a chevron between three bucks' heads cabossed argent. 3. Argent, three capons sable.*

CREST. *Out of a coronet or, lined gules, a griffin's head azure, beaked and eared gold, and charged on the neck with a crescent.*

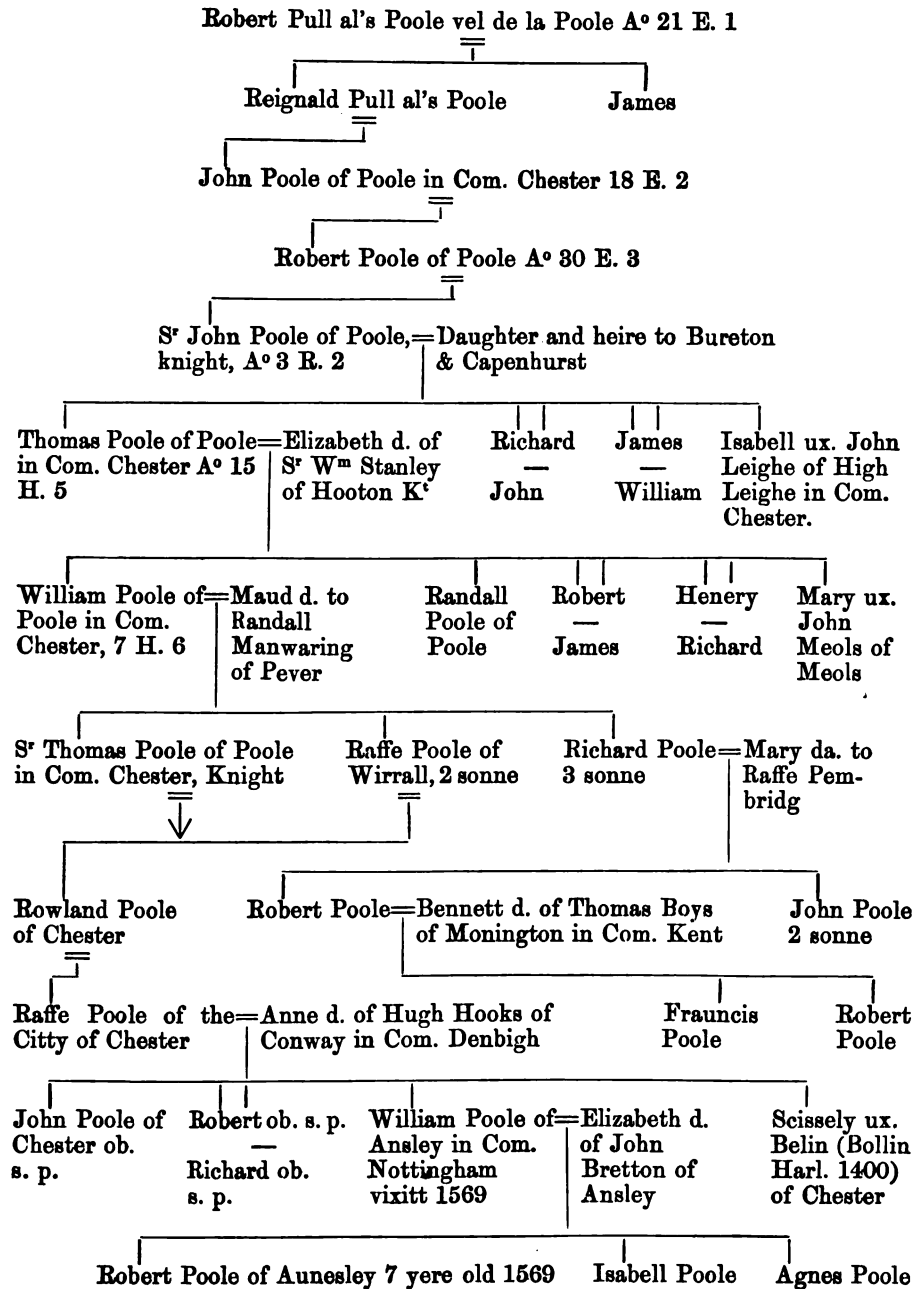

# Trussell.

ARMS. *Quarterly*:—1 and 4. *Argent fretty, gules on each joint a bezant, a bordure azure.* TRUSSELL. 2 and 3. *Vaire, a fess sable.* MARMION.

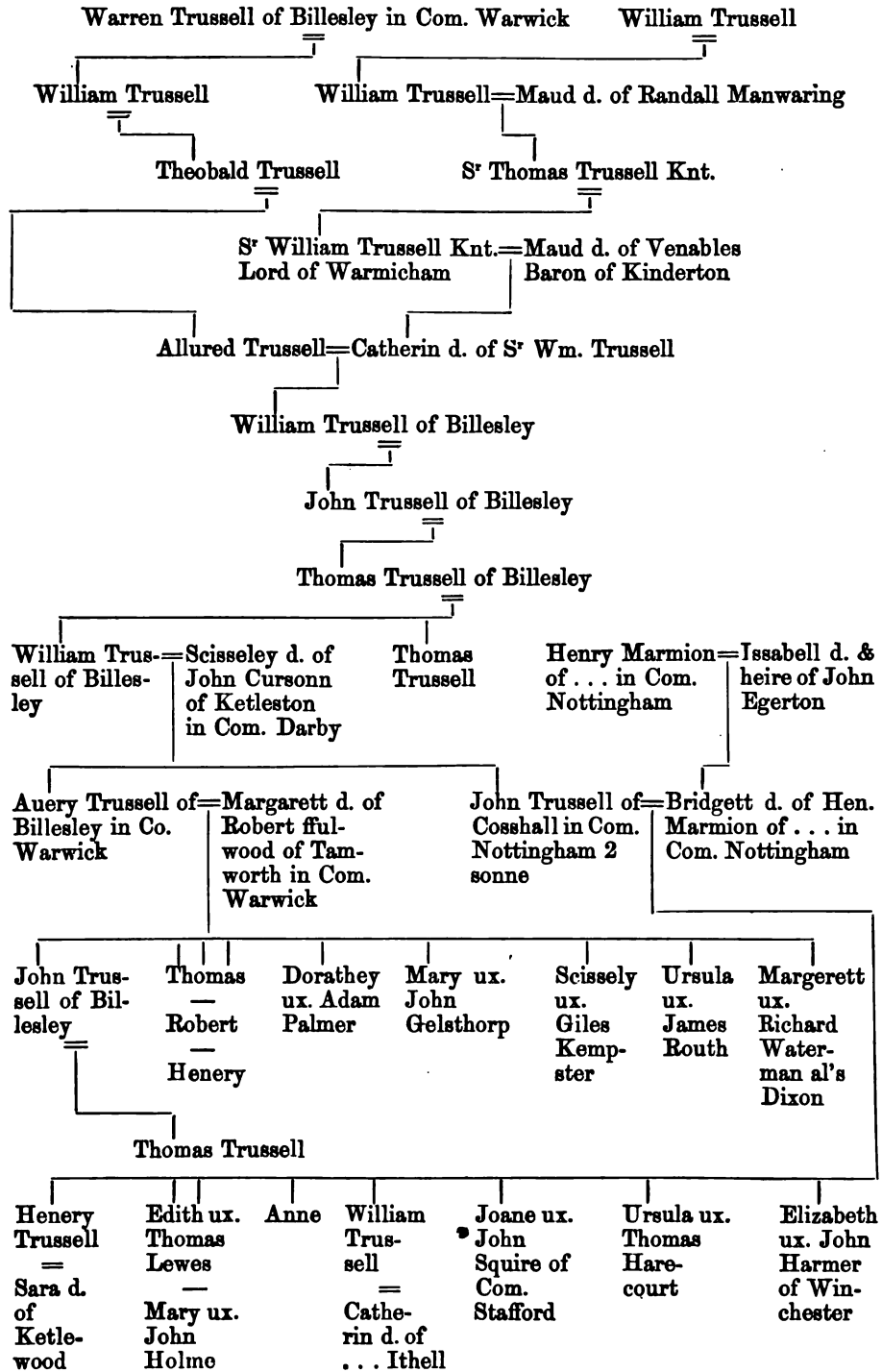

# Elwis.

ARMS. Quarterly:—1. Or, a fess azure, a bend gules. 2. Sable, a lion rampant or, within a bordure gobony sable and ermine. 3. A fess between three masers. 4. Argent, a chevron engrailed between three lions rampant sable.  
 CREST. Five arrows, four in saltire and one in pale or, flighted and barbed argent, entwined by a snake gules.

These 4 coats with the Crest was set out for Will'm Elweys of Broxton in Com. Nottingham by Clarencealx Cooke.

William Helwish al's Elwis of Asham in Com. Nottingham—... d. of ... Levesey (Leuesley Harl. 1400)

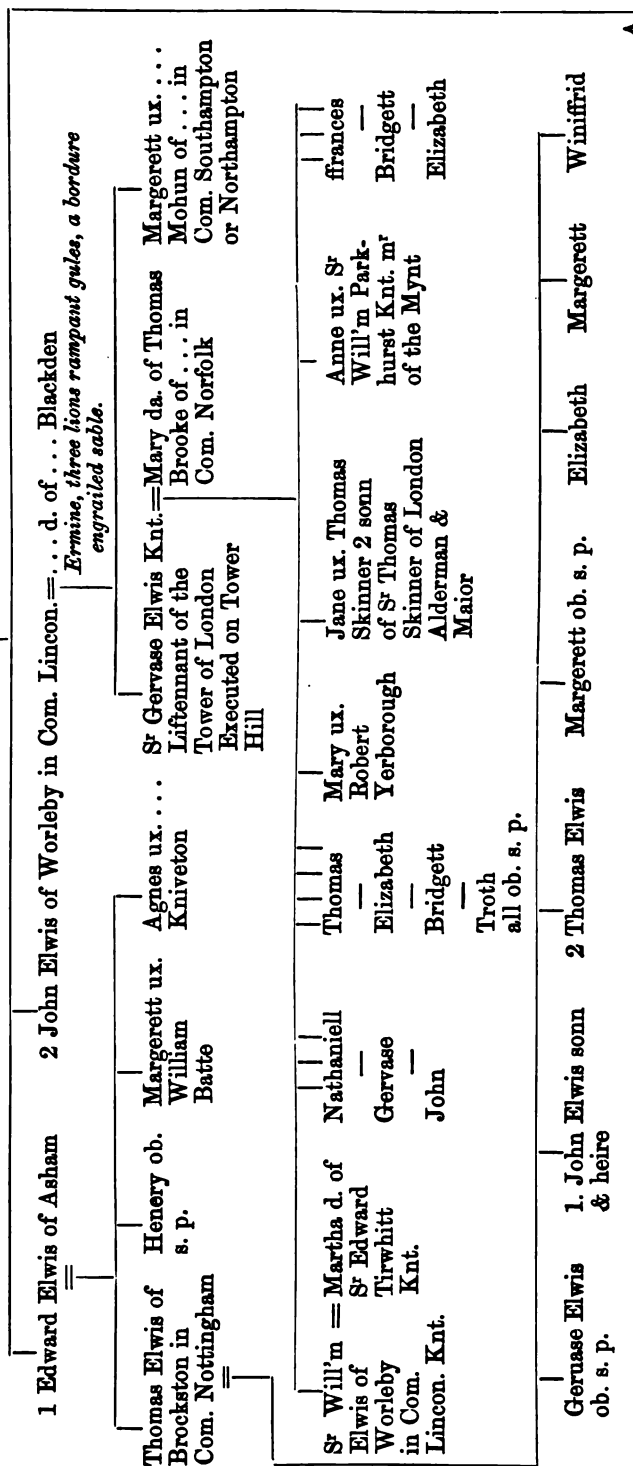

Sr Gervase Elwis Knt.—Mary da. of Thomas Brooke of ... in Com. Norfolk  
 Liffenant of the Tower of London  
 Executed on Tower Hill

Margerett ux. ... Mohun of ... in Com. Southampton or Northampton

Anne ux. Sr Will'm Parkhurst Knt. m' of the Mynt

Bridgett

Elizabeth

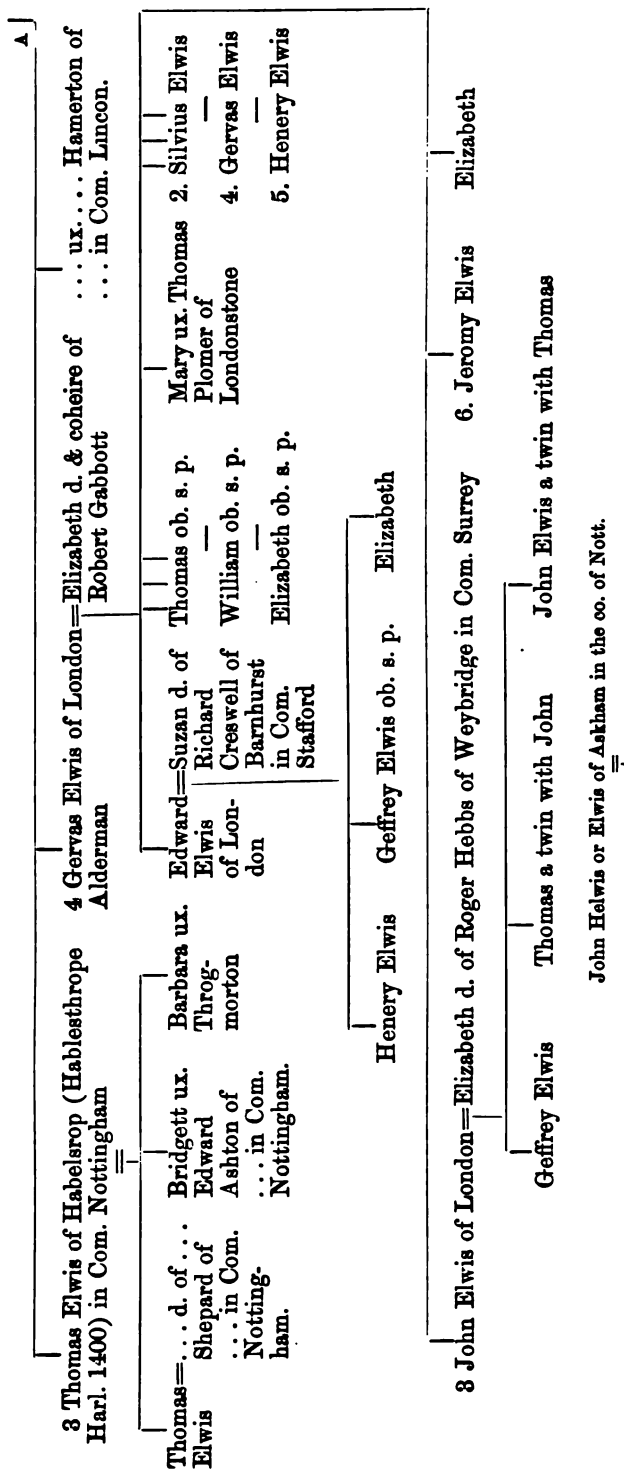

St Jeruas Helwis lieutenant of the Tower married Mary the da. of Brooke of Norff. Pray set downe Brooke's coate of Armes.  
Quere what kin the Alderman of London was to the Leutenant of the Tower.

**Osborne.**

**ARMS.** *Quarterly* :—1. *Quarterly ermine and azure, a cross or.* 2. *Two bars, and on a canton gules a cross argent.* 3. *Argent, a chevron between three annulets vert.* 4. *Azure, on a fess fleury between three lions passant or, as many peewits proper.*  
**CREST.** *An heraldic tyger or, maned sable, and charged on the shoulder with a pellet.*

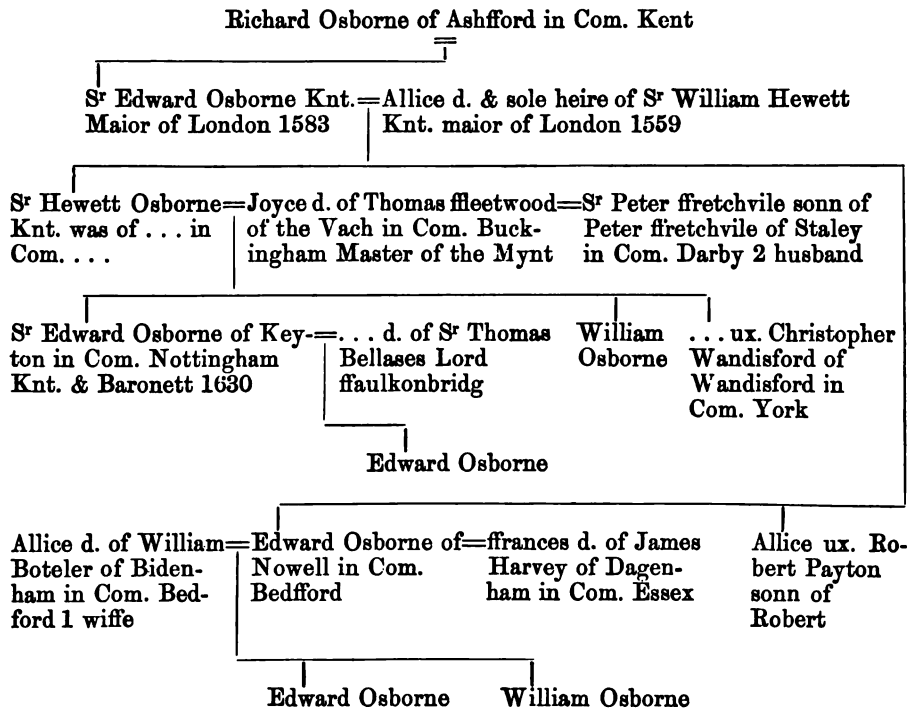

## Longford.

**ARMS.** *Quarterly* :—1. *Paly of six or and gules, a bend argent, charged with an annulet sable for difference.* 2. *Paly of six or and gules, on a chief azure a bar dancetté or.* 3. *Argent, a fess dancetté between ten billets sable, a label gules.* 4. *Quarterly, argent and gules.*

The entire coat is charged with an annulet for difference.

George Longford a yonger brother of Longford  
of Longford in Com. Darby

Nicholas Longford

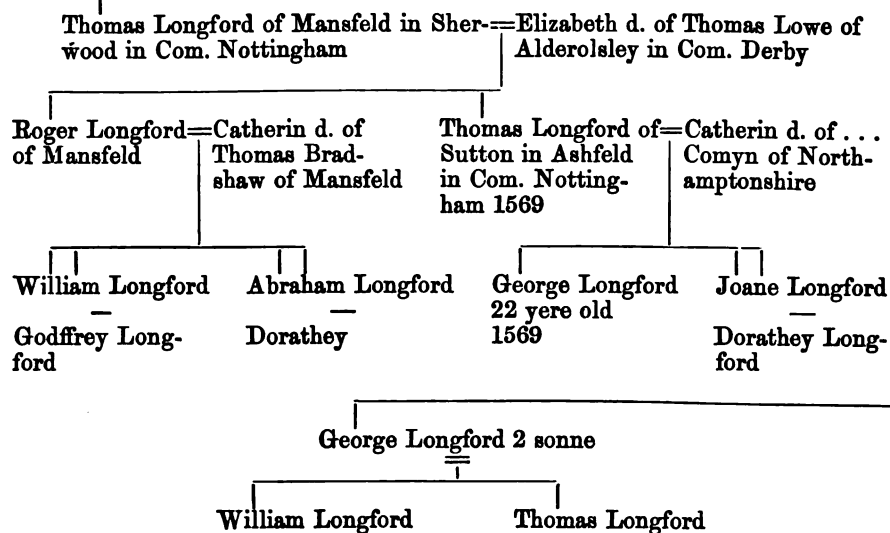

## Fenton.\*

**ARMS.** *Quarterly:—1 and 4. Argent a cross between four fleurs-de-lis sable. FENTON. 2. Or, a lion rampant gules, collared argent. MALLORY. 3. Azure, semée of cross crosslets and a lion rampant argent. BRETOFTE.*  
**CREST.** *Out of a coronet an arm embowed in armour or, in the hand a sword argent, hilted or.*

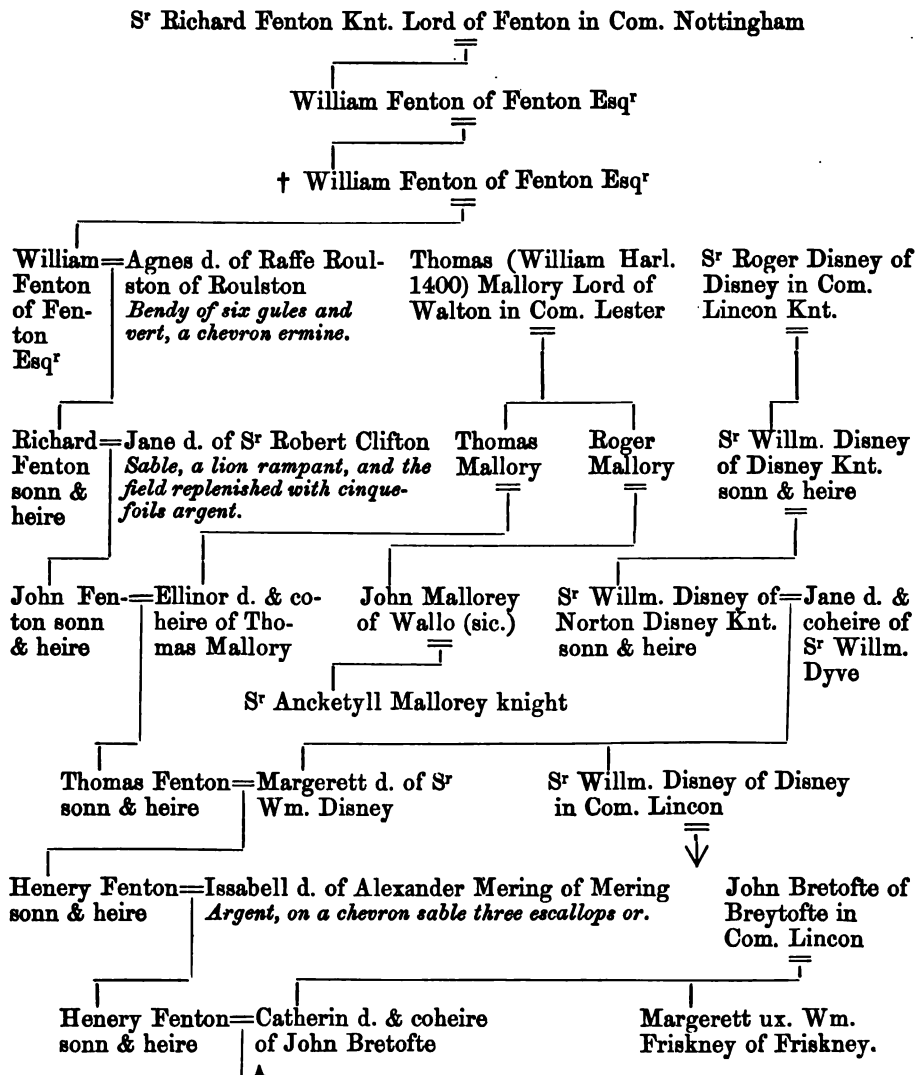

\* This pettegre is sett out by Clarenceulx Cooke and by him subscribed.  
 † Omitted in Harl. MS. 1400.

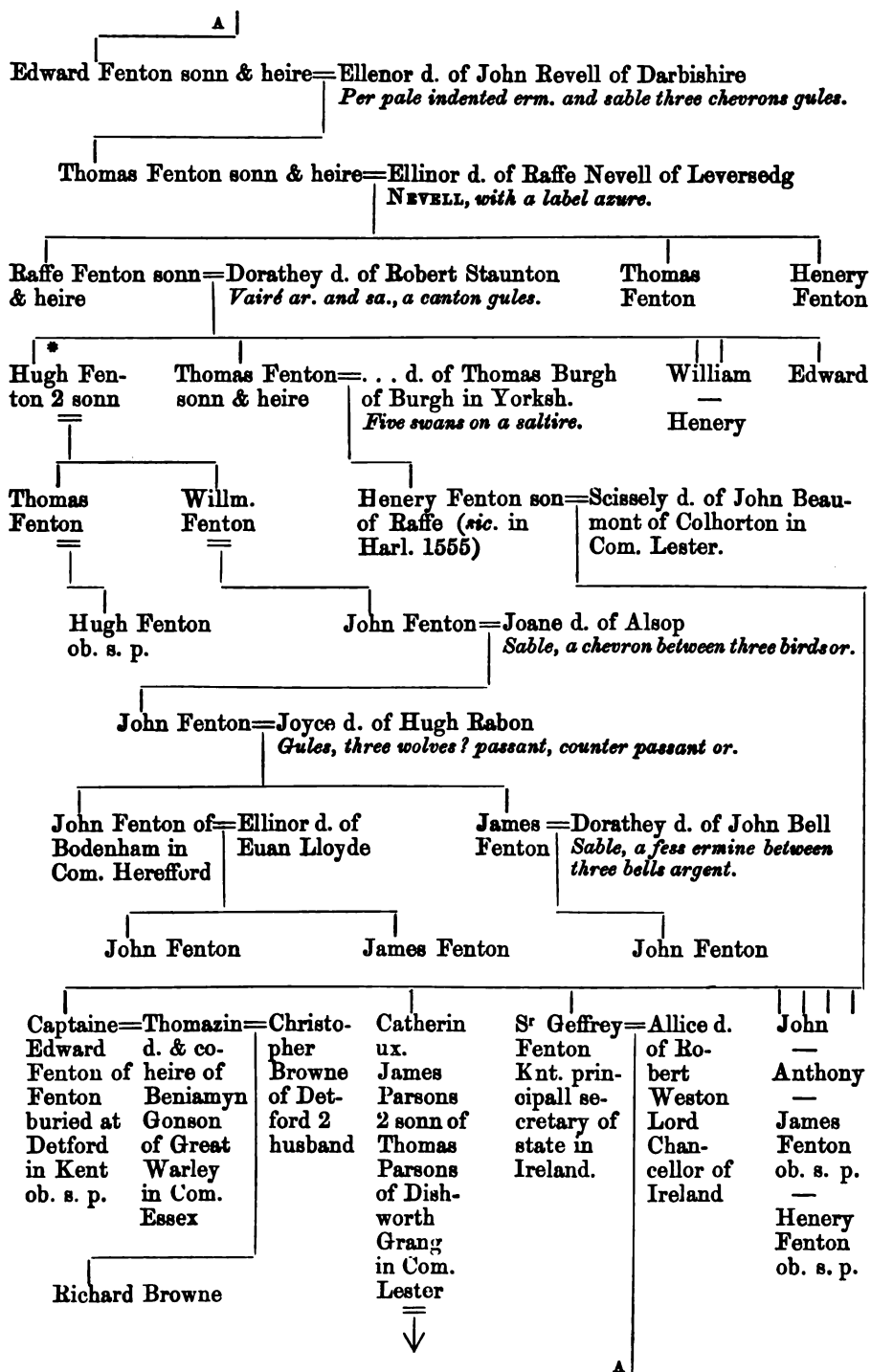

\* So much of this descent of Fenton as Hugh from the red lyne I tooke out of a pettegree subscribed by Mercury Pattent Blawmantell with these words following subscribed at the bottom Concordat cum originali genelogia Galfredi Fenton militis J. P. Blumantle wch S<sup>r</sup> Geoffrey Fenton's pettegree I copied by the originall subscribed by Clarenceulx Cooke in which there is no mention at all made the above named Hugh. (The line here referred to is in red ink, and is that connecting Hugh with Raffe Fenton his father. This part of the pedigree is omitted in Harl. 1400.)



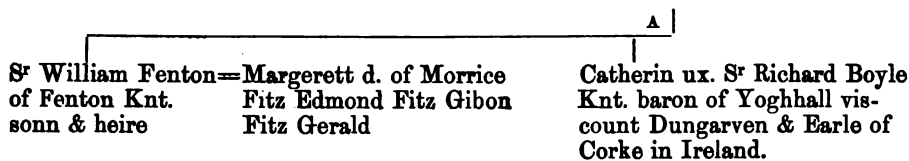

## Samon.

**ARMS.** *Quarterly:—1 and 4. Sable, three salmons haurient argent. 2. Argent, a bend azure between a mullet in chief and an annulet in base gules. 3. Argent, on a bend engrailed sable three mullets of the field.*

**CREST.** *Out of a coronet gules a pelican's head or, beaked and vulned gules.*

John Samon of the towne of Nottingham a benefactor=  
 to the building of St. Maryes Church there

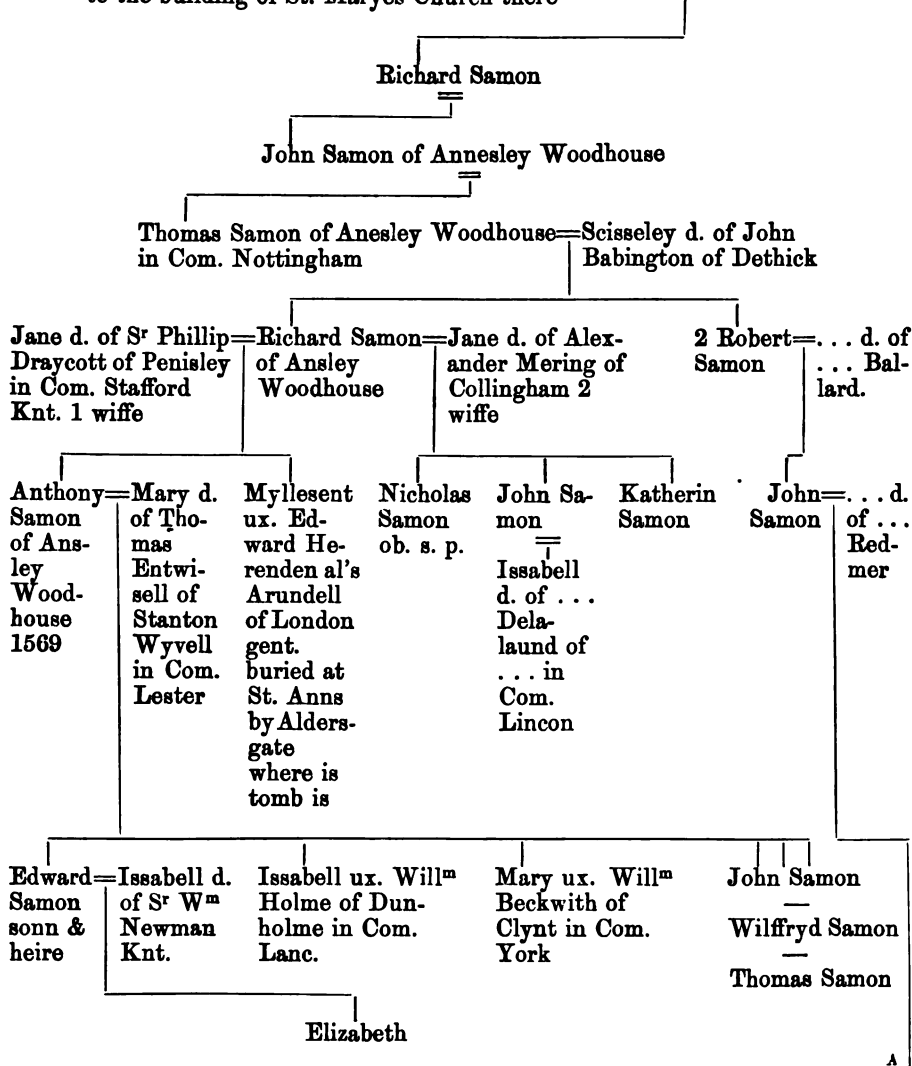

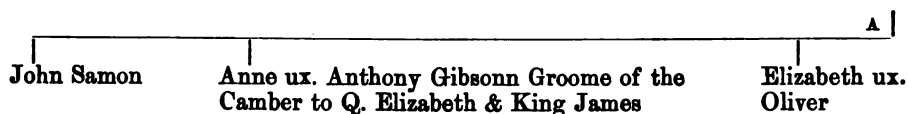

## Baker.

**ARMS.** *Ermine, on a chief vert two boars' heads or.*

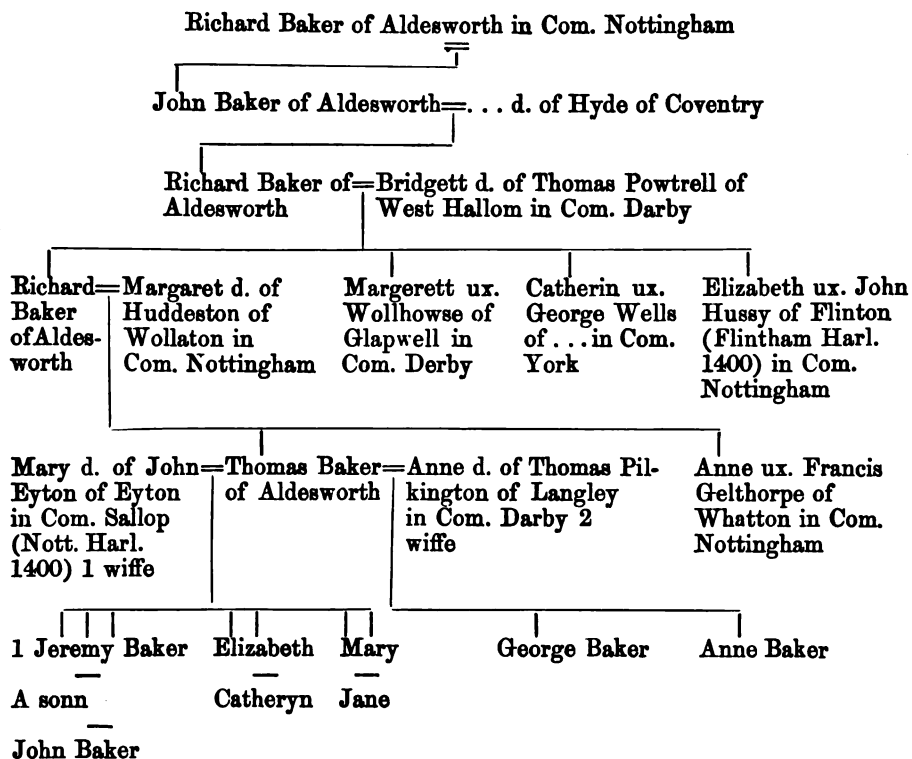

**Dabridgecourt.**

ARMS. Quarterly:—1. *Ermine, three bars humetté gules, a crescent for difference.* 2. *Gules, two lions passant guardant argent (or Harl. 1400), collared azure.* 3. *Per pale indented argent and gules.* 4. *Azure, a cross moline or, a bordure argent.* 5. *Gules, a lion rampant argent, a bordure engrailed or.* 6. *Argent, six lioncels rampant gules, 3. 2. and 1.* 7. *Three leopards' faces.* 8. *Argent, a stag couchant proper.* 9. *Argent, a fess gules between three birds vert, beaked, legged, and collared of the second.* 10. *Azure, semée of fleurs-de-lis, and a lion rampant guardant argent.* 11. *Vert, a lion rampant argent.* 12. *Argent, a cross, and in the first quarter a fleur-de-lis sable.*

John Delamare Lord of Oxwich & Portnor in Wales

Sr Eustace Dampredicourt 2 sonn of the Lord Dampredicourt in Hennolt=Elizabeth d. of John Lord Wake & Raffe Delamare  
 Came into England with Queene Philip wiffe to King Edward the 3  
 widow of John Erle of Kent

Sr Sanchett Dabridgecourt Knt. one of the first founders of the order of the garter

William Delamare=Janett d. & coheire of David ap Ivangrch of Neth

Sr John Dabridgecourt Knt.=Maud d. of Sr Richard Bromhall Knt. & widdow of Robert Touchett of . . . in Com. Chester

John Delamare

John Dabridgecourt Esq'

John Delamare=Avice d. & coheire of John Penris in Bower (of Gower Harl. 1400)

Robert Delamare whose heire general married to . . . Mansell

Peeter

Sr Nicholas Dabridgecourt of Stratfieldsay . . . d. of . . . Lord Say of Strafeld- Say in Com. Southampton

Sr Thomas Delamare Knt.

A

B

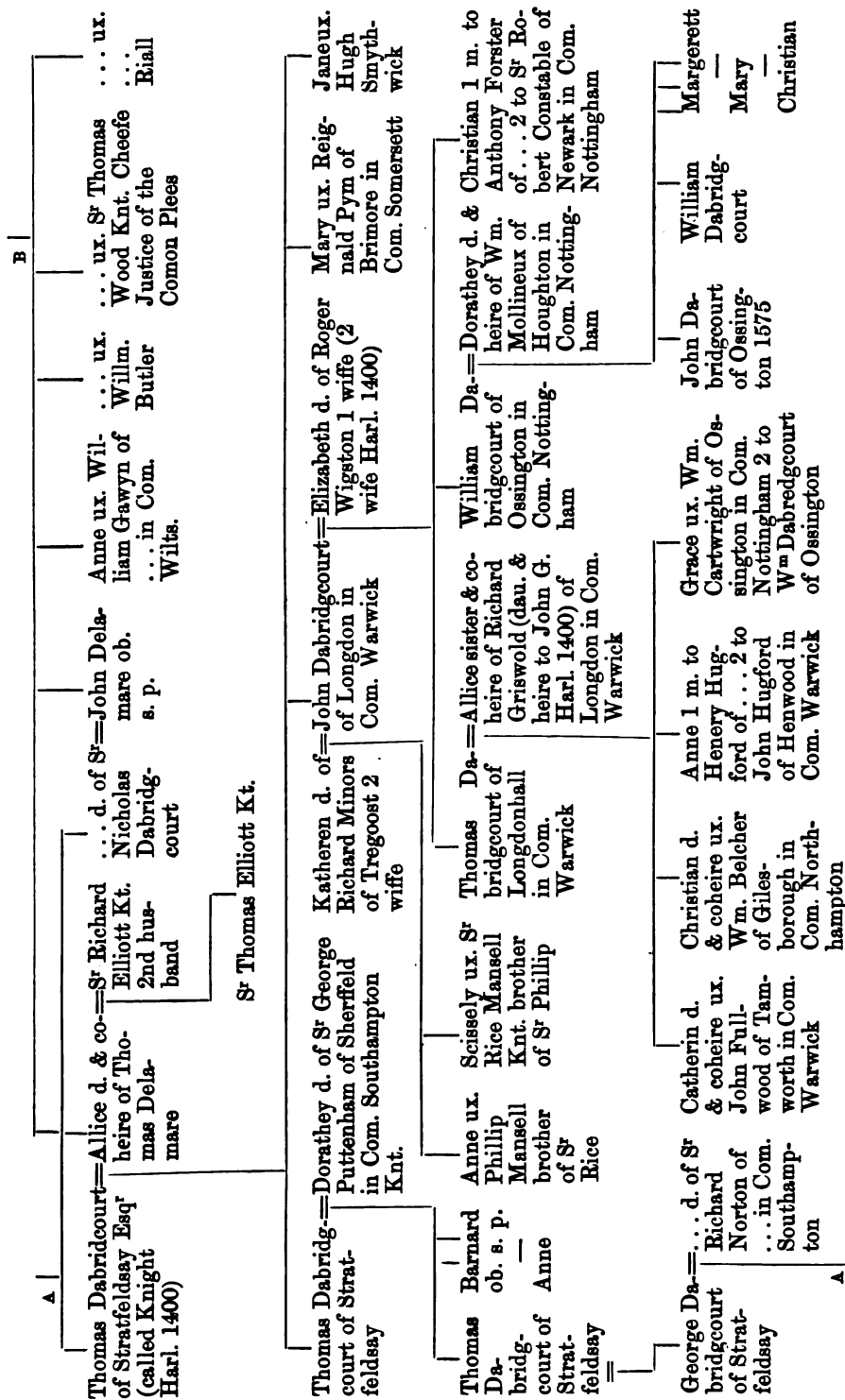

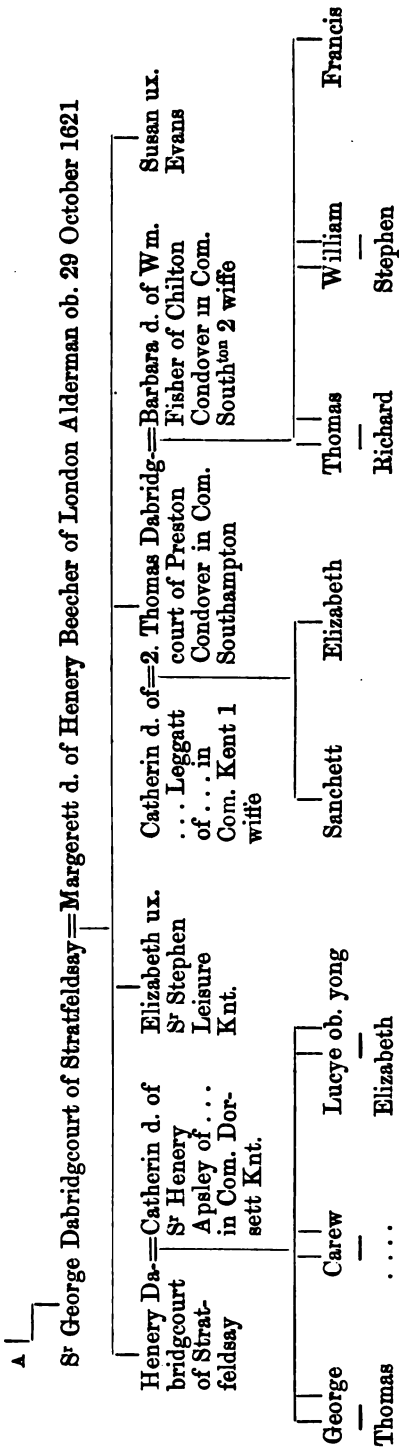

## Constable.

ARMS. *Quarterly* :—1. *Quarterly gules and vair a bend or, a crescent for difference.* 2. *Chequé or and gules, on a chief argent a lion passant sable.* 3. *Argent, two bars engrailed sable.* 4. *Argent, a chevron between three martlets sable.* 5. *Gules, an eagle displayed argent and charged on the breast with a crescent.* 6. *Argent, a bend sable.* 7. *Gules, a cinquefoil pierced argent.* 8. *Gules, a lion rampant vair.* 9. *Or, on a cross sable five crescents argent.*

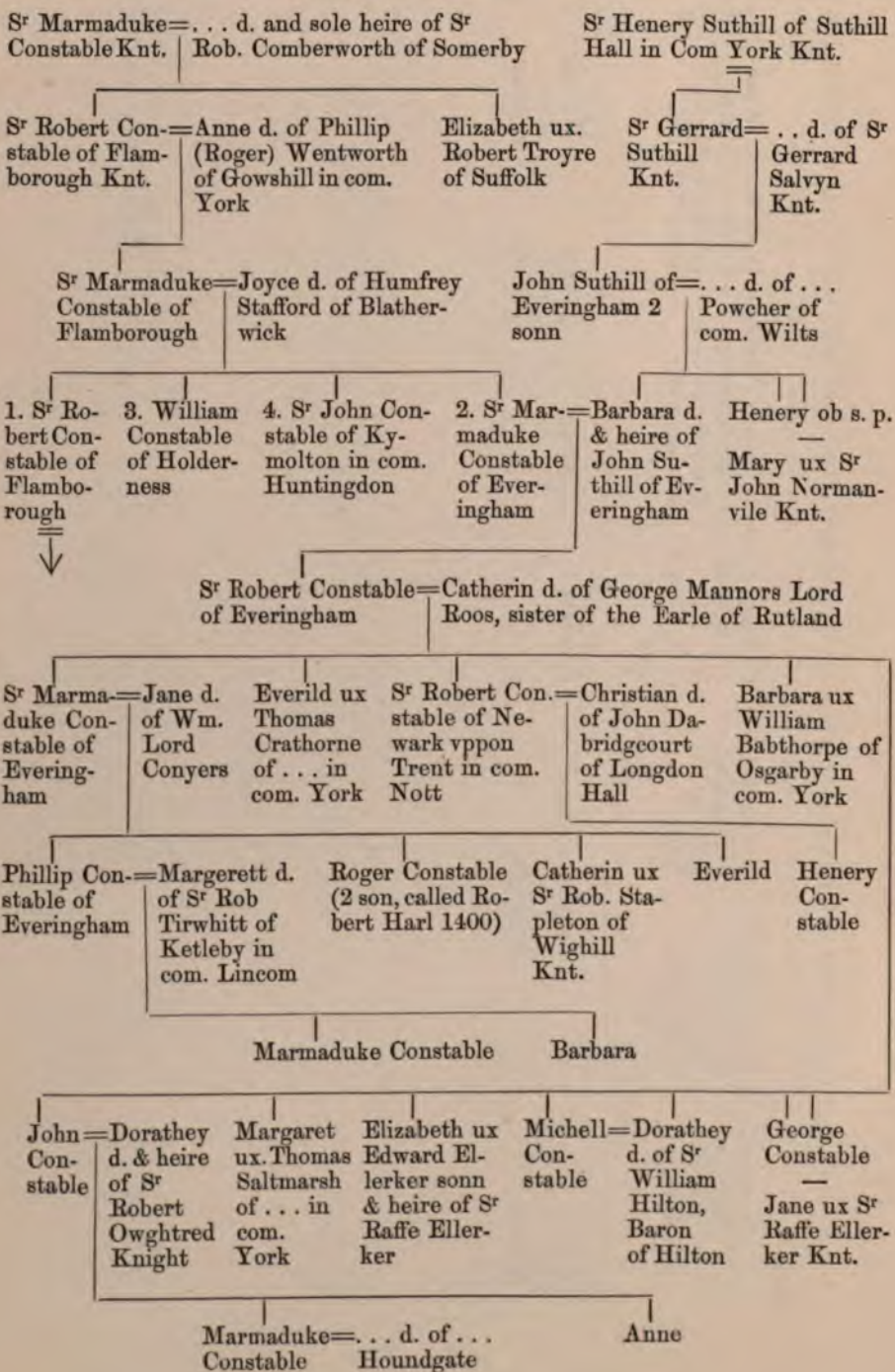

## Cressy.

Christopher Cressy of Fishbrooke (Firbroche Harl. 1400) in Com. York

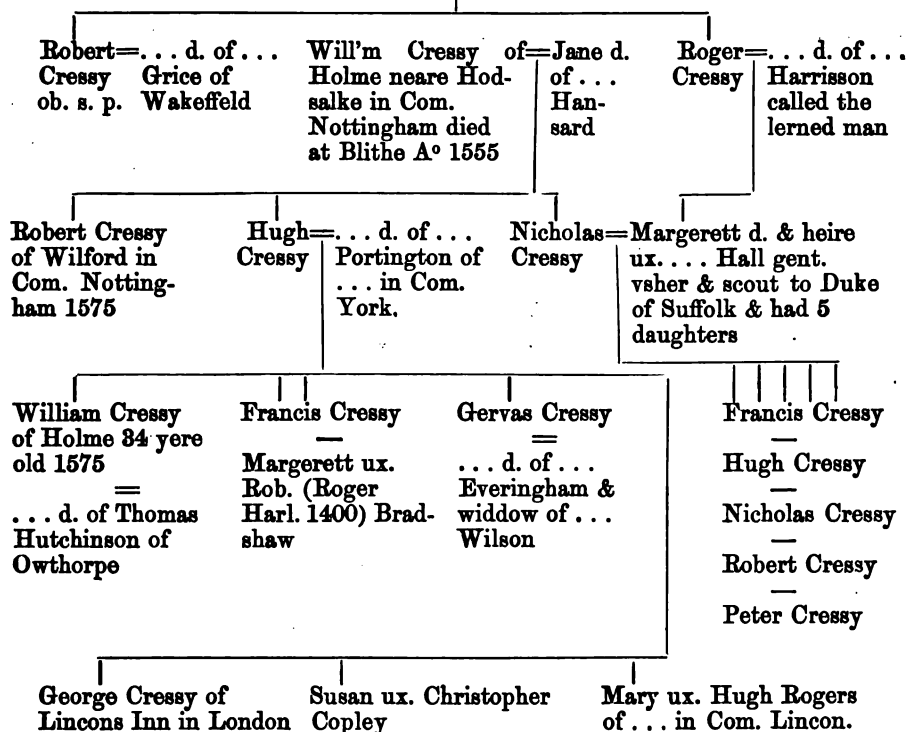

## Bassett.

**ARMS.** *Quarterly:—1. Three piles meeting in base, on a canton argent two bars nebulée sable. 2. Or, a chief azure. 3. Or, on a fess between four fleurs-de-lis gules, two of the field. 4. Ermine, on a bend gules cotised sable, three mullets or.*  
**CREST.** *A boar's head.*

Simond Bassett Lord of Sapcotts

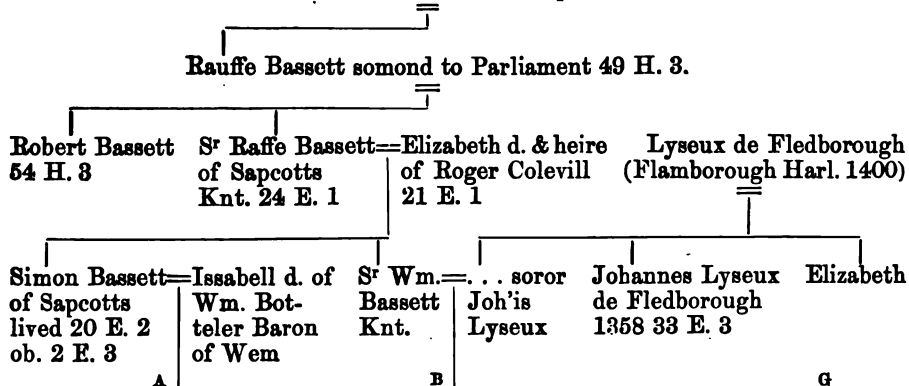

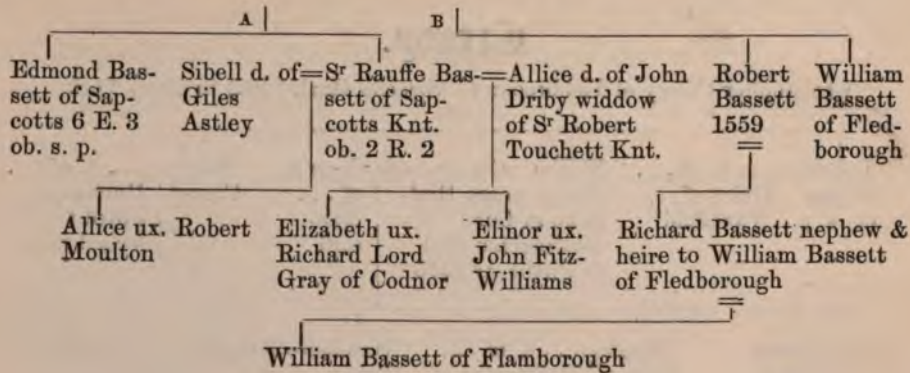

## Bassett.

ARMS. *Or, three piles meeting in base gules, a canton vair.*

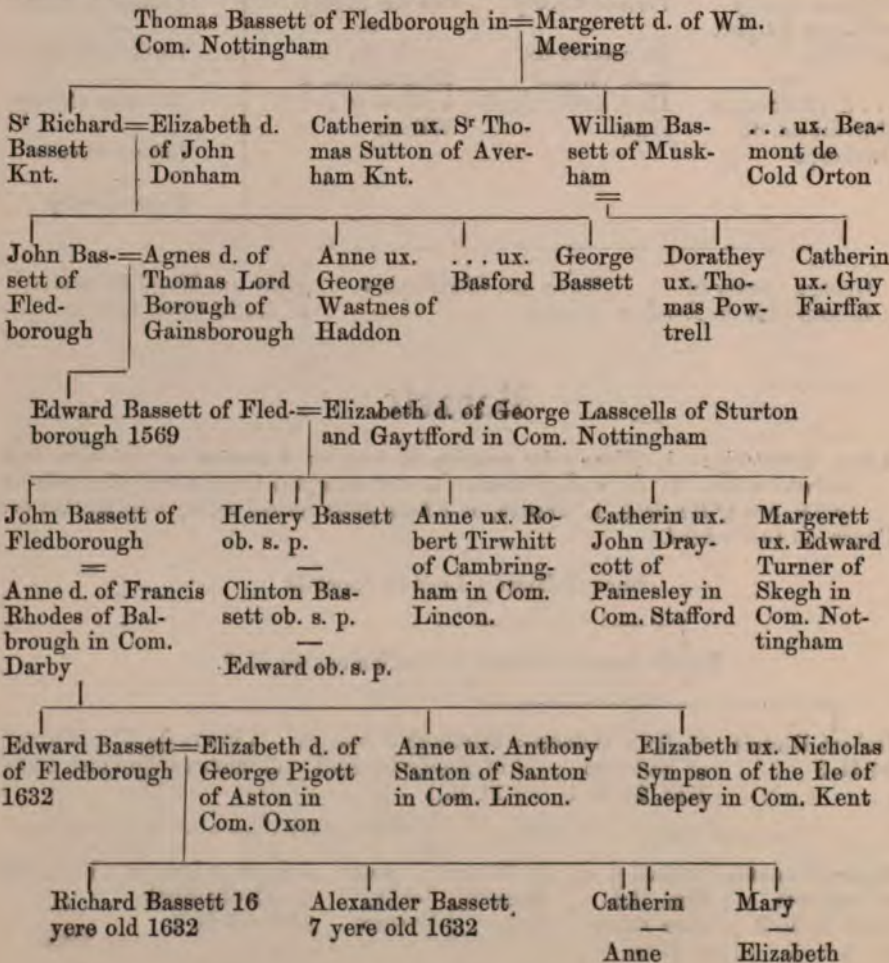



**Dod.**

**ARMS.** *Quarterly:—1 and 4. Argent, on a fess gules between two cotises wavy sable, three crescents or. 2. Per pale gules and sable an eagle displayed argent. 3. Or, a cross patée fitchée sable. (Over all a crescent for difference in Harl. 1400.)*  
**CREST.** *A garb or, environed with a snake proper.*

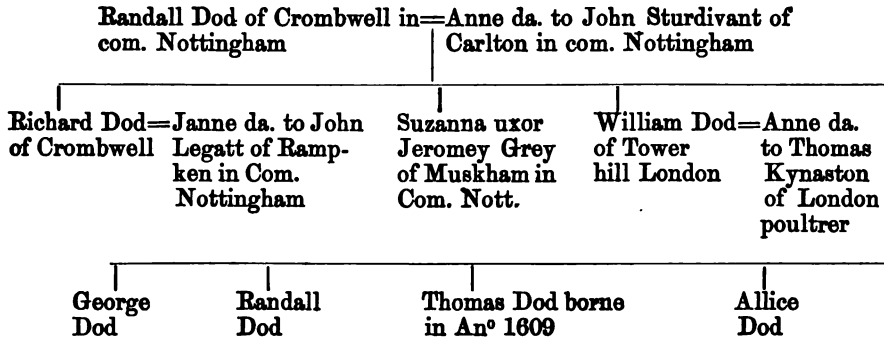

**Eyre.**

**ARMS.** *Argent, on a chevron sable three quatrefoils or, an annulet for difference gules.*

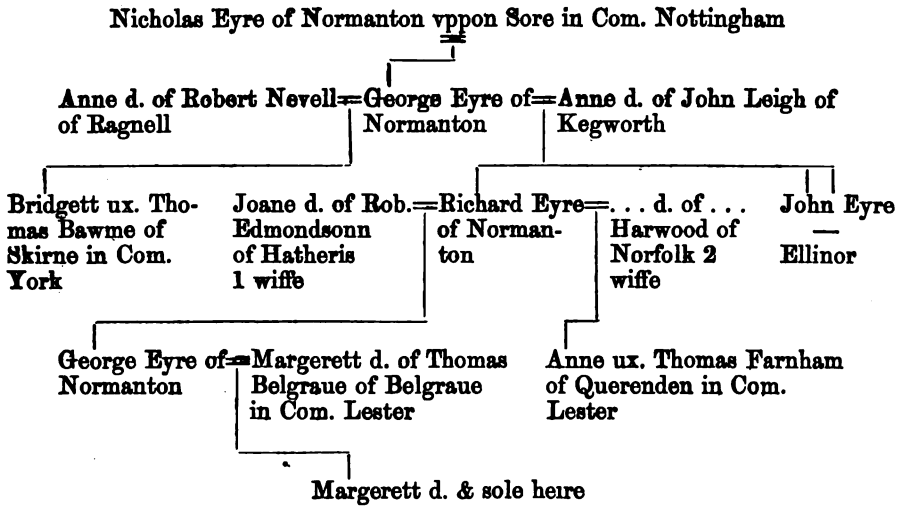

**Perpoint.**

Ex Chartis Hen. Perpointe Militis.

Notum sit omnibus tam futuris quam p'ntibus quod ego Lionius de Malnoer consilio uxoris meæ et ceterorum amicorum n'rorum dedi et p'nti charta mea confirmavi m<sup>o</sup> Will'mo de Dunigtone et hæred' suis ad tenend' de me et hered' meis in feudo et hæreditate in maiori Anastan 4 bouatas t'ræ cum o'bus perti-

nentijs etc. totam hanc terra' dedi ei liberam et quietam ab omni seruicio pro decima parte seruicij unius militis etc. Testibus hijs Pagano de S'ca Maria, Will'mo filio Rautri, et Helia filio eius, Rado Tortismariæ, Ada de S'ca Maria, Simone de Breton, Gilberto de Anastan, Ricardo de Montega, Suano de Chiueton, Will'mo Diacono, Petro Leymur, et Tor fratre eius.



Quæ excerpti ex registro euidentiarum Henrici Perpoint Militis.

Obitus D'ni Michaelis Mannours militis aº regni R'g Henrici filij Regis Joh'is 39 eodem die fuit Annora filia sua ætatis 3 annor'.

Obitus D'næ Annoræ Perpoint filia p'dci Mich'is et sororis Joh'is Mannors Aº D'ni 1314.

Obitus D'ni Rob'ti Perpoint Militis 6 nonas Martij Aº D'ni 1333.

Obitus D'ni Edm' Perpoint militis apud Leybourne in Vasconia cuius ossa iacent in eccl'ia de Holme Aº D'ni 1370 L'ra Dominicali C.

Joh'es Heriz miles habuit exitum Joh'em Heriz militem et Saram, Joh'es filius habuit exitu' Matildam quondam uxor' Ric'i Delariuer ch'r matrem Margaretæ quondam uxoris Rogeri Bellers militis matris Margaretæ quondam uxoris Roberti Swillington militis patris Margaretæ quondam uxoris Joh'is Graa militis: Sara p'dca habuit exitum Henricu' Perepont milite', patrem Edmondi Perepont militis, patris Edmundi Perepont militis, patris Henrici Perepont militis, patris Henrici Perepont Armigeri, patris Henrici Perepont militis Aº 1463.

O'ibus xp'i fidelibus ad quos p'nes scriptu' p'ven'it Henricus Perepont miles et Annora uxor eius salutem. Noueritis me concessisse hominibus Comunitatis villa de Sneynton t'ras, &c. Dat' apud Holme Anno D'ni 1287 aº 15 E. 1.

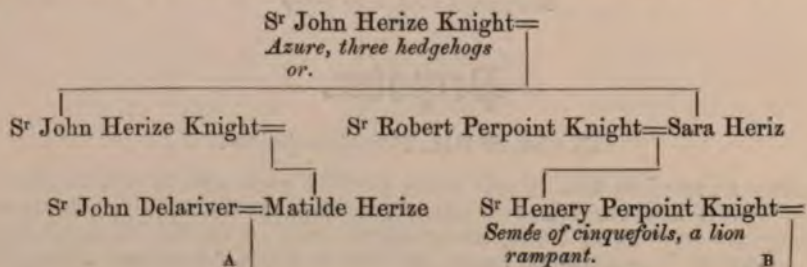

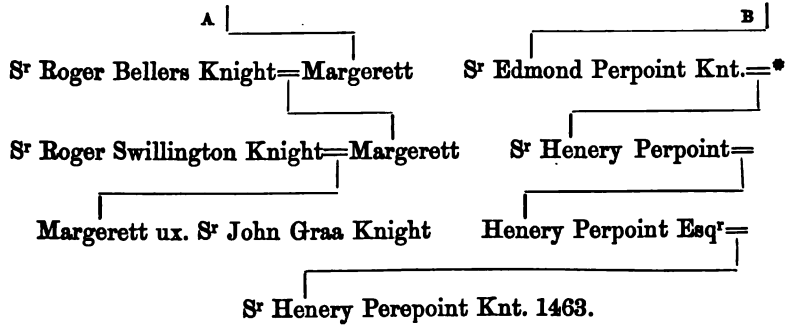

Sciant p'ntes et futuri quod ego Michael Mannvrs dedi Will'mo filio de Anastan dimid' bouata' t'ræ quam Joh'es Creue quonda' tenuit pro sexaginta solidis argenti quos mihi præmanibus dedit. Testibus Ric'o Clerico de latton, Ric'o Clerico de Bucton, Hasculpho de Mannours, & Johanne de Dunton.



Sciant pn'tes et futuri quod ego Henricus de Perpoint et Annora uxor mea dedimus Waltero Oliuer de Stretton maneriu' n'rum de Holme iuxta Radcliuæ super Trentam aduocac' eccl'ie cum o'bus alijs p'tinentijs &c. Hijs testibus D'nis Joanne de Annesley tunc Vicecomite Nottingham, Ric'o de Bingham, Waltero de Ludeham, Joh'e de Leke, Joh'e de Viliers, Militibus, Will'mo de Radcliff, Thoma Basill de eadem, Willielmo de Mareschall de eadem, Will'o de Leke, Nicholao de Buckton, Johanne Lutterell, Waltero de Mortein de Radcliffe, Hugone de Shelford de Lamcote, Simon de Rempston et multis alijs.

SEALS.—Round seal with coat of arms:—*Four barrulets, over all a lion rampant.* Oval seal, a female figure holding in her dexter hand a shield of this coat:—*A lion rampant within an orle of cinquefoils*; and in her sinister one with this:—*Six annulets.*

Omnibus xp'i fidelibus hoc scriptu' visuris vel auditoris Annora quæ fuit uxor Henrici de Perepont salutem. Noueritis me dedisse Will'mo de Langton vnu' toftu' cum crofto et i bouatum t'ræ in Holbebek Woodhouse iuxta Welbuck Hijs testibus Joh'e de Runce Hugone de Boure de Holbek et alijs.



\* There is a second S<sup>r</sup> Edmond in Harl. 1400.

Sciant p'ntes et futuri quod nos Rob'tus de Rasen et Annora uxor mea dedimus Rob'to filio Henrici de Perepont militis et hæredibus suis maneriu' n'rum de Suthanston. Testibus Johanne de Dinigton, Thoma Caily, Hugone de Serceby de Herthull, Joh'e Bernard de eadem, Joh'e de Aldham dewodsetes, Rogero de Watton. Dat' apud woodhouse iuxta Welbeck die Jouis prox' ante festu' S'ci Ambrosij Epi' A° 32 E. 1.



Hæc Indentura testatur q'd ego Rob'tus de Perepont miles dimisi Joh'i Torkerd vna' placeam t'ræ prout iacet in Newarke reddendo inde annuatim mihi et hæredib' meis octodecim denar' argenti' &c. Hijs testibus Joh'e Neifer, Henrico Mons, Johanne de Beckingham, Joh'e Thornheghe, Joh'e Campion et alijs. Dat' apud Newark 3 februarij A° 2 E. 3.



Sciant p'ntes et futuri quod ego Edmundus Perpont miles dedi Adæ de Babington necnon Joh'e de Turnhill Capellano hærebus et assignat' suis omnia ten'ta mea t'ras et prata redditus et seruicia quæ et quas habeo vel aliquo modo habere potero infra ciuitatem Lincolne Resham et Fiskerton &c. Hijs testibus Joh'e de Sutton de Lincoln, Will'o de Sutton de eadem, Ric'o de Gainesburgh de eadem, Will'o Hanney de eadem, Joh'e Friuile de eadem, Joh'e Rand de eadem. Dat' apud Lincoln iouis in festo S'cæ Margarete virginis a° 9 R. 2.



Nouerint vniu'si per p'ntes me Henr. Perepont militem recepisse de Radulpho D'no Cromwell centu' marcas sterlingoru' in præsoluconem certæ summæ pecuniæ predict' Domin' mihi debit super diuersis conuencionibus. Dat' A<sup>o</sup> 19 H. 6.



Sciant p'ntes et futuri quod ego Rob'tus de Perepont miles dedi Ric'o filio Joh'is de Kirnsale omnes terras &c. quas habui in Northanston. Hijs testibus D'no Nicho' de Worteley, Will'o de Clarell, militibus, Hugone de Serelby, Thoma Cailij, Stephano Deiuile et alijs. Dat' apud Northanston a<sup>o</sup> 11 E. 2.



Ex registro euidentiariu' Henrici Perpont Militis.

Memorandum quod Georgius Mowbegere iunior desponsauit Margareta' filiam Thomæ Chaucer et hæredem Thomæ Matirsey et habuit filium no'ie Bertramum Mowbegere et tres filias, vidzt Joannam, Margareta', et Isabellam, quæ quidem Isabella desponsata Joh'i Clifton militi, et obiit sine exitu, et pred'c'us Bertramus habuit exitu' Nicolau' Mowbegere militem qui quidem Nicholaus habuit tres filios vizt. Georgiu', Radu'm, et Bertramum qui obierunt sine exitu, et duas filias viz. Isabellam quæ nupta fuit Joh'i Burogh, et Matildam quæ nupta fuit Joh'i Kirmond adhuc sup'stes et in magna ætate et sine exitu, et memorandu' quod Johanna soror præfati Bertrami filiæ primogenitæ Georgii Mowbeger desponsata fuit Edmundo Perpont Militi et habuit exitum per se viz. Edmundu' Perepont militem filiu' suu', qui quidem habuit exitum viz. Henricum Perepont militem filium suum qui quidem Henricus habuit exitu' Henricu' nunc sup'stitem et alteram filiam nomine Margaretam quæ desponsata fuit Ankeri Frescheuile et habuit exitu' per se viz. Radulphum Frescheuile militem filiu' suum et Isabellam filiam suam qui quidem Radus' obiit sine exitu infra sponsalio et præd'c'a Isabella &c.

Note that the father of this S<sup>r</sup> George Monbocher was S<sup>r</sup> Bartram Monbocher who married Joane da. and sole heire to the yonger S<sup>r</sup> Guichard de Charrons whose father (eiusdem nominis) married Margarett daughter & coheire to S<sup>r</sup> Richard Sutton Vppon Trent in the county of Nottingham.

Bartram Monbocher = Margerett d. &  
*Argent three cups gules,* sole heire of S<sup>r</sup>  
*a bordure sable semée of* Richard Sutton  
*bezants* vpon Trent

S<sup>r</sup> Bartram Monbocher Knt. = Joane d. & sole heire of S<sup>r</sup>  
 Richard Charrons Knt.

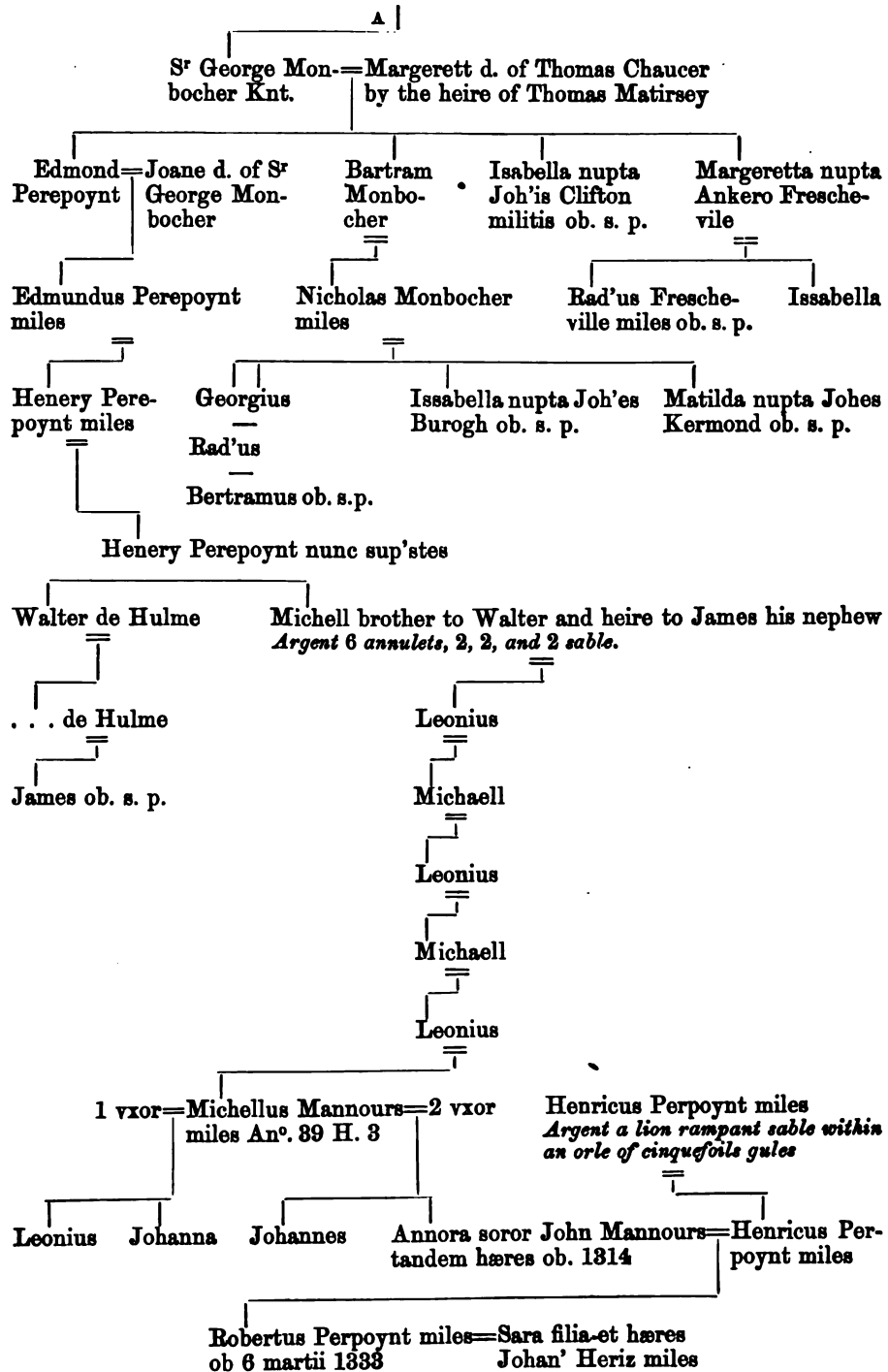

Placita coram Rege A<sup>o</sup>. 18 E. 1 Rot. 48 do proue all these descents from Michell the brother of Walter de Hulme to Annora the wife to S<sup>r</sup> Henry Perpont Knight wherein Richard Barry doth impleade the sayd S<sup>r</sup> Henry and Annora for that they distreyned his Cattell for x<sup>ii</sup> rent in Bazingfeild.

**ARMS.\*** *Quarterly*:—1. *Argent, semée of cinquefoils gules a lion rampant sable.* 2. *Azure, a chief chequé or and gules.* 3. *Barry of eight argent and gules, a lion rampant sable, over all a bendlet or.* 4. *Argent, six annulets 3, 2, and 1 sable.* 5. *Azure, three hedgehogs or.* 6. *Argent, an escutcheon sable within an orle of cinquefoils gules.* 7. *Argent, on a bend between six cross crosslets gules three bezants.* 8. *Argent, three fleshpots (sic) gules, a bordure of the last bezanté.* 9. *Gules, a chevron between three escallops argent.* 10. *Per pale argent and gules, a bend, counterchanged.* 11. *Argent, on a chief azure two fleurs-de-lis or.* 12. *Or, a lion rampant vert.* 13. *Azure, a cross patonce argent.* 14. *Sable, three saltires engrailed argent.* 15. *Vert, a saltire engrailed or.* 16. *Sable, a pale engrailed between six cross crosslets or.* 17. *Argent, a cross sable fretty or.* 18. *Sable, a lion rampant argent crowned or.*

**CREST.** *A lion rampant sable between two wings argent.*

**SUPPORTERS.** *(only one drawn in the trick) A lion rampant sable, langued and dented gules.*

**MOTTO.**—"PIE REPONTE TE."

**ARMS.** *Quarterly*:—1 and 8. *Argent, semée of cinquefoils gules, a lion rampant sable.* **PERPOINT.** 2. *Argent, six annulets, two, two, and two, sable.* **MANNOURS LOWDHAM.** 3. *Azure, three hedgehogs or.* **HERRIZ.** 4. *Argent, three cups gules, a bordure, sable, bezanté.* **MONBOCHER.** 5. *Gules, a chevron between three water bougets or.* **EMPSON.** 6. *Argent, three bendlets engrailed sable.* **EMPSON.** 7. *Argent, on a fess sable between three fleurs-de-lis gules as many bezants.* **THWAITES.**

There is another trick of the 1st, 2nd, and 3rd quarterings with this note, "thus quartered in the vissitation made in 1614, by S<sup>r</sup> George Norroy," and another, 1, 2, and 3 as before. 4. *On a chief two fleurs-de-lis.* 5. *A lion rampant within a bordure engrailed, a crescent for a difference.* 6. *A lion rampant within a bordure.* 7. *Bendy of ten.* 8. *Gules, on a saltire argent a marilet (?) sable.*

**CRESTS.** 1. *A lion's jamb erased sable, holding a cinquefoil gules, and charged with three bezants in pale.* 2. *A fox passant gules.* 3. *A hedgehog or.*

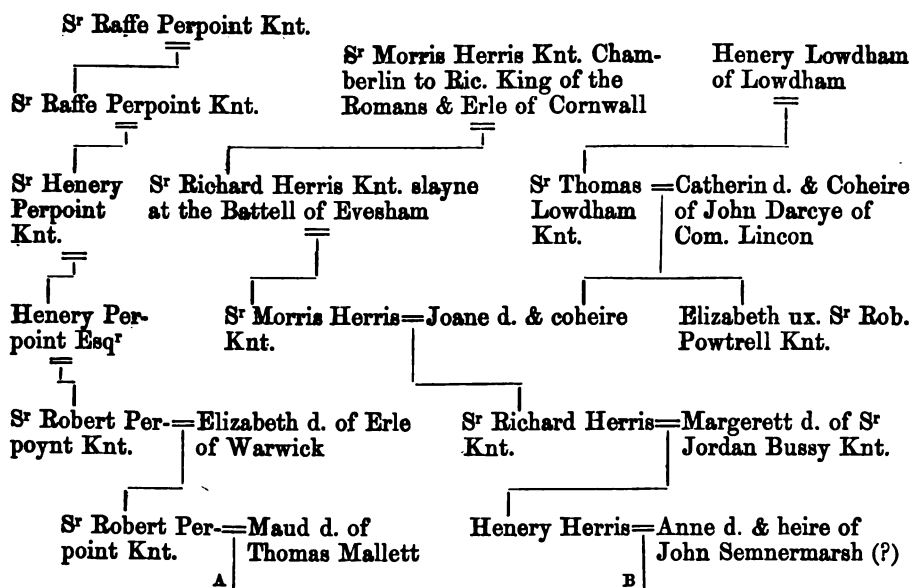

\* The quartered Coates, Crest, and Supporters as they were sett out by S<sup>r</sup> William Segar, Garter for the Earle of Kingeton.

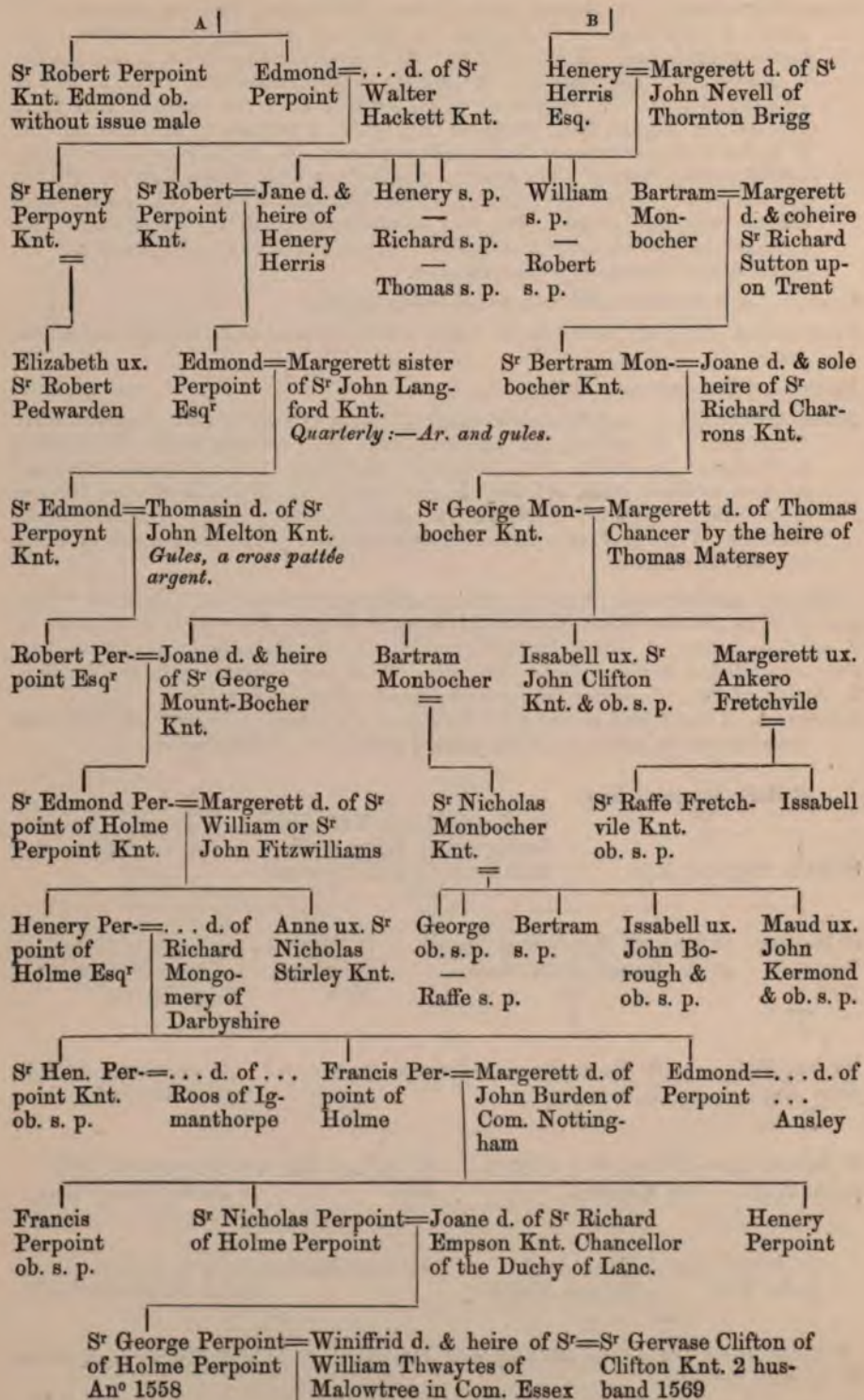



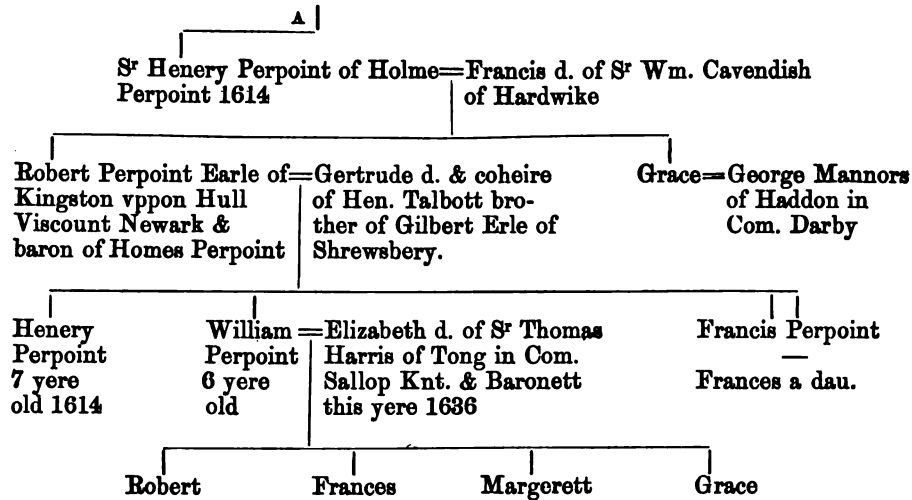

Ex Chartis et aliis Recordis in Custodia Georgii Lascells de Eileston in  
Com' Nottingham 1624.

R. de Molbray omnibus audientibus videntibus legentibus hanc cartulam Gallis Anglis o'ibus hominibus suis amicis Gallis et Anglis salutem Sciatis me dedisse, A uxori mea filia Walteri de Gaunt et neptæ Alani comitis centu' librat' t'ra in dote et decem militis feufatos scilicet Castellu' de Malefart cum saca pro xx libris et caua cum soca pro 50 libris Neuibalda xxx libris. Hijs testibus Alano Comite, Will'o de Merlan, Sampson e cl'ico Ric'do Burdett, Bertramo Haghett, Waltero de Flamenuilla, Rualdo Constabulario de Richmont, Conono Archidiacono, Rad'o filio Ribaldi Escolando, Roberto Camerario, Hugone filio Gernegan, Alano Pincerna, Pigoto de Lascellis, Acaria Alano Delamara, Rob'to filio Copsi, Hugone Camen et cum disparem eam dedi ei et concessi rogatu Bertæ Comitissæ et accreui in dote duas milites feufatas et decem libratas terræ in popligtona. Teste Andrea presbitero qui desponsauit eam et Berta Comitissa, et Isac p'sbitero, Conano Archidiacono, Tetbaldo Capellano comit' Radulpho filio Ribaldi Escolando, Alano pincerna, Picot de Lascellas, Ric'o Burdett, Hugone filio Gernegan, Rogero de Cundeo, Valete.

Sara de Lucy petit versus Matilda' de Lucy medietatem manerij de Angle (in Com' Essex) et Estanford vnde Ric'us de Lucy fuit seisitus t'pe Regis Henrici aui de Ricardo descendit Galfrido filio et hæredi et de Galfredo Ricardo filio et hæredi qui obiit sine hærede descendit Herberto vt fratri et hæredi et de eo Matildæ filiæ et hæredi istius Saræ et Matildæ et filiarum et hæredu' de vno patre et vna matre D'nus Ricardus Rex maritauit præd'cas Matildam et Saram duobus fratribus Galfrido de Lascelles et Will'mo de Lascelles qui tenuerunt eas t'ras tam in Anglia quam in Normannia et postea Rex Joh'es perdidit Ducatu' Normanniæ, Galfridus et Matildis venerunt in Angliam et Will'us et Sara permanebant in Normannia et tenuerunt te'ras ibidem et ordinatur per consiliu' R'g quod nullus de patria Regis Franciæ debet respondere in Anglia.

Paschæ Fines a<sup>o</sup> 31 E. 1 Ebor'.

Johannes de Lascelles filius et hæris Will'mi de Lascelles de Otringham defuncti qui tenuit die quo obiit de Rege in capite vt de honore Albamarle in Holdernes viz. Otringham, Frockingham, Kingston et Seton xij carucatas terræ dat' Regis pro releuo suo de t'ra præd'ca vt de quart' parte feod'.

Will'us Lascelles de Otringham defunctus 31 Ed. 1

Joh'es Lascelles filius et hæres a° 31 E. 1

Cononanus Archid' omnibus hominibus Com. & omnibus suis Francis et Angli-  
cis salutem me dedisse et concessisse Rad'o de Hoilanda Esteuening et omnia illa  
quæ pertinent Esteuening in Hoylanda in feodo et hæreditate ita bene et libera-  
liter et honorifice sicut Barones cum melius teneant. Teste Rogero de Lacella,  
Galfrido Trihanton, Rogero Tesard, Henrico Clerico, Onte Russella, & Hugone  
filio suo, Atsur Algar, Thoma filio Griketell.

Gilbertus de Aleby & Nigellus filius eius o'ibus videntibus l'ras has salutem  
Scitote quod ego Gilbertus et hæredes mei concessimus Thomæ fratri meo et hære-  
dibus suis i carucatam & dimidiam in Sixstanby liberam et quietam ex omnibus  
consueud' cum omnibus p'tinentijs suis in pratis et t'ris et in aquis et in pascuis  
et toftis et in villa et extra villam scilicet faciend' forms' seruicium ex hæc pred'ca  
carucata & dimidia quantu' pertinet ad sex carucatas et dimid' de feodo militis  
pro hoc concessione dedit mihi Thomas frater meus Palfridam ferrant et filio meo  
gladium suum. Teste Galfrido de Fort, et Galfrido filio eius, Gaufrido de Insula,  
et Will'mo de Perir, Gaufrido de Aleby, et Rapieo fratre eius, et Nigello filio eius,  
et Rob'to de Bouill, et Hugone fratre eius, Ricardo filio Hugonis de Scaldeford, et  
Achardo fratre eius, Rodberto de Arraby, et Rogero fratre eius, Henrico de Moli-  
tum, et Waltero de Mealtum.

This Deede being in the custody of the sayd George Lascells Esq'  
who being descended of the coheires of Bellers who was seized of Sex-  
stanby and Bellers being a brother of Mowbray and this Nigellus de  
Aleby being also a brother of Mowbray and Thomas brother of Nigellus  
vnto whom this Sixstanby being graunted doth concurre to proue Bellers  
and a Mowbray and Nigell to be brother and the bearing the lion ram-  
pant white.

Ex antiqua pergamena in custodia Georgii Lascells Ar. A°  
1614.

Memorandum de o'ibus seinoru' D'ni Jacobi Bellers a conquestu usqu' in  
diem confectionis istius scedulæ D'ni Hamondi Bellers fr'is D'ni Mowbray D'ni  
Sampsonis Bellers D'ni Rad'i Bellers et Emmæ uxoris eius quæ fuit filia D'ni  
Walteri Foluile Will'mi Bellers et Mabilæ uxoris eius filia Domini Rob'ti  
Aungeruile Hamundi Bellers et Mabilæ filia D'ni Maunsell Domini Rad'i Bellers  
et Sibillæ uxoris eius filia Joh'is de Perers et Joh'es de Perers p'diet' sponsauit  
Ceciliam de Quenesburgh et Will'm Bellers de Kirkby qui fuit frater Hamundi  
Bellers Ar. Rad'i Bellers et Agathæ filia D'ni Ric'i de Bingham Jacobi de Bellers  
et Margaretæ uxoris eius filia Nicholai Bernake et Ellenæ uxoris eius quæ fuit  
soror D'ni Philippi de Lymbury Johannes Bellers et Elizabethæ uxoris eius filia  
Antonij Howby Joh'es Bellers.

In an Inquisition taken at Melton in com. Leicester A° 16 E. 4 after the death  
of John Bellers are found his heires generall.

Placita a° 20 E. 1 rot. 129 Ebor'.

Margeria quæ fuit uxor Henrici de Midleton optulit se quarto die versus  
Edmundu' filium Roberti de Lascelles et alios quare ipsi bona et catalla ipsius  
Margeria vi et armis apud Berthelby inuenta asportauerunt ad graue dampnum  
ipsius Margeria.

Robertus de Lascelles

Edmundus de Lascelles A° 20 E. 1

Notum sit omnibus tam p'ntibus quam futuris quod ego Gaufridus de Lascells dedi et concessi et hæc mea charta confirmaui eccl'ie S'cæ Mariæ de Giseb' t'ram illam quam Herbertus de Eboraco tenuit de patre meo et postea de me &c. Hijs testibus Rodberto de Baius, Rodberto Bosse de Thorpe, Reginaldo de Thunstall, Will'mo filio Warner &c. et alijs. Sans dat'.



Radulphus de Lascells miles dedit Waltero de Lascells filio suo decem libras annui redditus ereunt de o'ibus t'ris et ten'tis quæ vel quas habuit ex dono et concessione Lucie le Constable in villa et territorio de Escrick sibi et hæredibus de corpore suo l'itime procreatis. Hijs testibus Will'mo de Ellerton Rectore eccl'ie de Escrick, Joh'e de Newton, Henrico Bawnes, Joh'es de Selby et alijs. Dat' apud Escrick die Jouis prox' post festu' S'ca Lucæ Evangelistæ Anno D'ni 1349 A° 13 E. 3.

From this Walter is descended the family of Lascells of Eileston in Com. Nottingh' a° 1614.

Hæc Indentura testatur quod Rad'us filius Rogeri de Lascells militis ad firmam dimisit Waltero de Lascells avunculo suo totu' manerium de Ellerton in Com' Ebor'. Dat' apud Ellerton A° 2 R. 2.

SEAL. A round seal, on a shield *three chaplets*.

Radulphus de Hoding et Duncanus de lascelles et Christiana uxor eius dant 20<sup>li</sup> et 4 marcas pro habenda terra quam Walterus de Windesore tenuit die quo obiit in capite.

Claus a° 44 H. 3 pro t'ra  
in Gamesby et Glasamby

Radulphus de Lemington  
├──  
└──  
    ├── Christiana uxor  
    │    Tho. de Lascells  
    └── Eua uxor  
        Robti Auenell

De term° Hillary A° 5 E. 4 North'ton.

Johannes Bellers Ar' per Simonem Burton attornatu' suu' petit versus Gerardu' Fosbrok 6 mess' 6 virgat' t'rae et 8 mercat' reddit' cum p'tinen' in Cranford qua Joh'es filius Hugonis de Bernak nuper de Drayton dedit Anktiro filio Walt' filij Gilberti de Howby et hæredibus de corpore eiusdem Anketine exeuntibus et quod post mortem p'dei Anketini et Alicie filie et hæredis præfati Anketini et Antonij filii et hæredis præd'ie Alicie et Elizabethæ filie et hæredis eiusde' Antonij præfato Johi' Bellers filio et hæredi præfate Elizabethæ descendere debent per formam donationis prædict' et vnde dicit quod p'd'cus Joh'es filius Hugonis de Bernak dedit ten'ta p'd'ca &c. præfato Anketino et hæredibus de corpore præfati Anketini exeuntibus in forma p'd'ca virtute cuius doni idem Anketinus fuit seisitus in t'ris illis &c. in dn'co suo vt de feodo &c. t'pe pacis t'pe D'ni nuper regis Angliæ tertij post conquestum progenitoris D'ni R'g nunc capiendo inde explecia ad valentiam et de ipso Anketino descendit ius per formam &c. cuidam Alicie vt

filia et hæredi et de p'd'ca Alicia descendit eius cuidam Antonio vt filio et hæredi et de ipso Antonio descendit eius cuidam Elizabethæ vt filia et hæredi et de ipsa Elizabetha descendit ius per formam doni Johannis Bellers qui nunc petit vt filio et hæredi etc. prædictus Joh'es Bellers recuperat seisinam versus p'd'cum Gerardu' Fosbrok.

Partitis t'rarum et ten'torum nuper Joh'is Bellers Armigeri.  
Pars Marinæ Grene.

Manneria de Kettleby et Stamesby præter certas t'ras et ten'ta  
in Sistonby assignata parti Jasparis Ruskin xxxiiij<sup>li</sup>

Pars Johannis Villiers.

Maneriu' de Howby Sewelby Retharby et Oleby xxxiiij<sup>li</sup> ix<sup>s</sup> iv<sup>d</sup>  
Parua Dalby ex manerio xxvj<sup>s</sup> viij<sup>d</sup> }  
Burton S'ci Lazari vij<sup>s</sup> ix<sup>d</sup> } xxxiiij<sup>s</sup> v<sup>d</sup> xxxiiij<sup>li</sup> iij<sup>s</sup> ix<sup>d</sup>  
na libra peperis et xvj pulli

Pars Jasparis Ruskin.

Maneriu' de Sutton Sheinton Beceleston Aston Flamvile et Burton xij<sup>li</sup>  
Holt lvj<sup>s</sup> viij<sup>d</sup> }  
Drayton xxv<sup>s</sup> ij<sup>d</sup> } iiiij<sup>li</sup> ii<sup>s</sup> x<sup>d</sup>  
Blaston x<sup>d</sup> }  
Melton vij<sup>li</sup> xvj<sup>s</sup> iiiij<sup>d</sup> }  
Meltborne xxxiiij<sup>s</sup> } lvij<sup>s</sup> ix<sup>d</sup>  
Somerby et Parua Dalby }  
Siftonby de Joh'e Measure xliij<sup>s</sup>  
Item de Joh'e Dalby xxx<sup>s</sup>  
Item de Ric'o Webster xxxiiij<sup>s</sup>  
Item de Joh'e Richard vij<sup>s</sup>  
Summ' huius partis xxxiiij<sup>li</sup> vij<sup>s</sup>

Particuli subscripti assignati pro Cantaria perpetua

Joh'is Bellers Armigeri

Mansio capitalis in Howby  
Turlington xlvij<sup>s</sup> }  
Magna Dalby xxxiiij<sup>s</sup> } 103<sup>s</sup> viij<sup>d</sup> et mansio  
Bradley vi<sup>s</sup> viij<sup>d</sup> }  
Bringhurst xvj<sup>s</sup> }

Annuitates concessæ per Johannem Bellers Ar.

Personis subscriptis pro t'mino vitæ.

Bartholomew Villiers iiiij<sup>li</sup> }  
Thomæ Tomson xxvj<sup>s</sup> viij<sup>d</sup> }  
Roberto Clay xiiij<sup>s</sup> iiiij<sup>d</sup> } ix<sup>li</sup> xiiij<sup>s</sup> iij<sup>d</sup>  
Isabella Milliner xx<sup>s</sup> }  
Margareta Bellers moniali liij<sup>s</sup> 4<sup>d</sup> }

Memorandum it is agreed that the Anuitie granted to Bartholmew Villiers and others aforesayd shalbe equally borne at the costs of all the parties that is to wit of each of them the third part during the tyme that they be graunted.

Item it is agreed that during the life of Katherine Digby late the wife of John Bellers Esq' John Villiers shall pay yearly to Dame Marine Greene in reecomence for Kettleby & Sistonby viij<sup>li</sup> xij<sup>s</sup> ix<sup>d</sup> to be made sure thereof.

Item Jasper Roskin shall in likewise pay to the same Dame Marine in like recompence yearly to the sayd Dame Marine during the life of the sayd Digby xxvj<sup>s</sup> viij<sup>d</sup> and the sayd Jasper other xxvj<sup>s</sup> vij<sup>d</sup>.

Item it is agreed that in as goodly hast as can be thought by the aduice of good substantiall the states of the land according to the partitions be ingrossed together with the state that shalbe made to the sayd Katherine Digby &c. that is to say to each of the part to them assigned in taile & fault of issue the remainder to be either of the copartners of the Moietie of the same entayle.

Sciant p'tes futuri quod ego Rad'us Beler miles D'nus de Kettleby dedi concessi et hac p'nti carta mea confirmaui Hugoni Beler filio meo vnam selionem in campo de Sexstanby viz. apud le longspellowes &c. Testibus magistro Hamone Beler, Will'mo de Sixstanby, Johanne Mabill et alijs.

Sans date.

SEAL. Upon a round seal, on a shield a lion rampant.

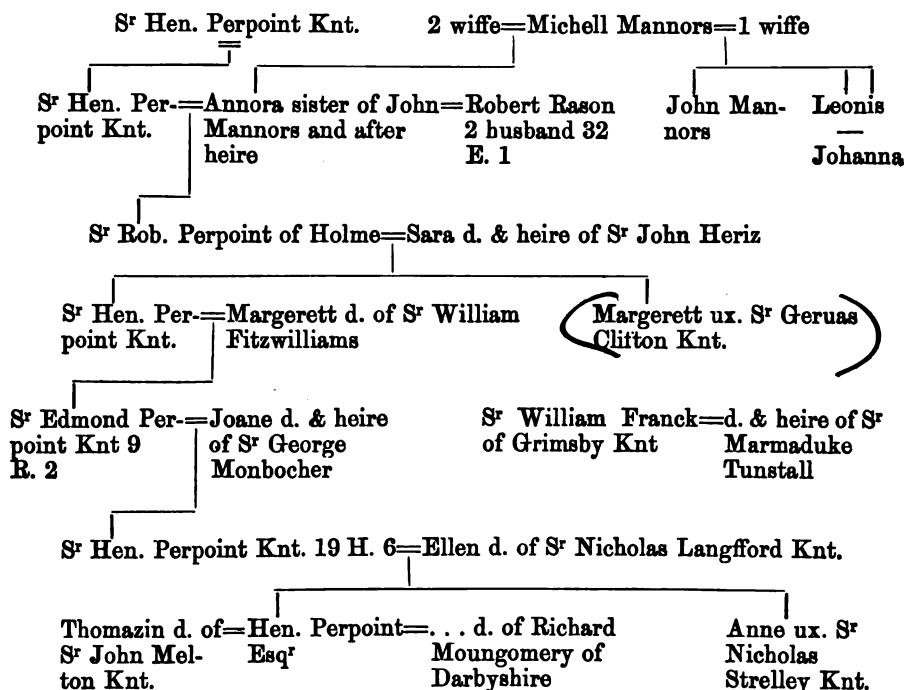

This is the top of the descent of Perpoint as it sett out in the vissitation in the office made 1614.

The following pedigree is from Harl<sup>s</sup> 1400.

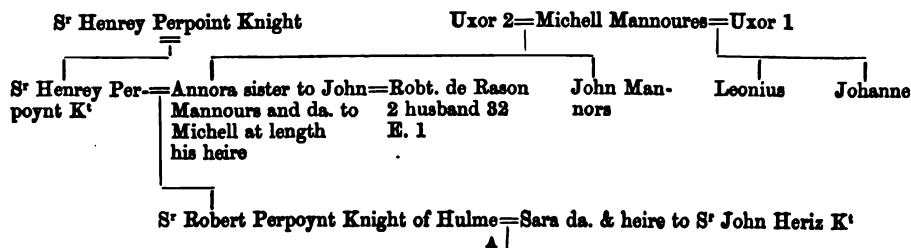

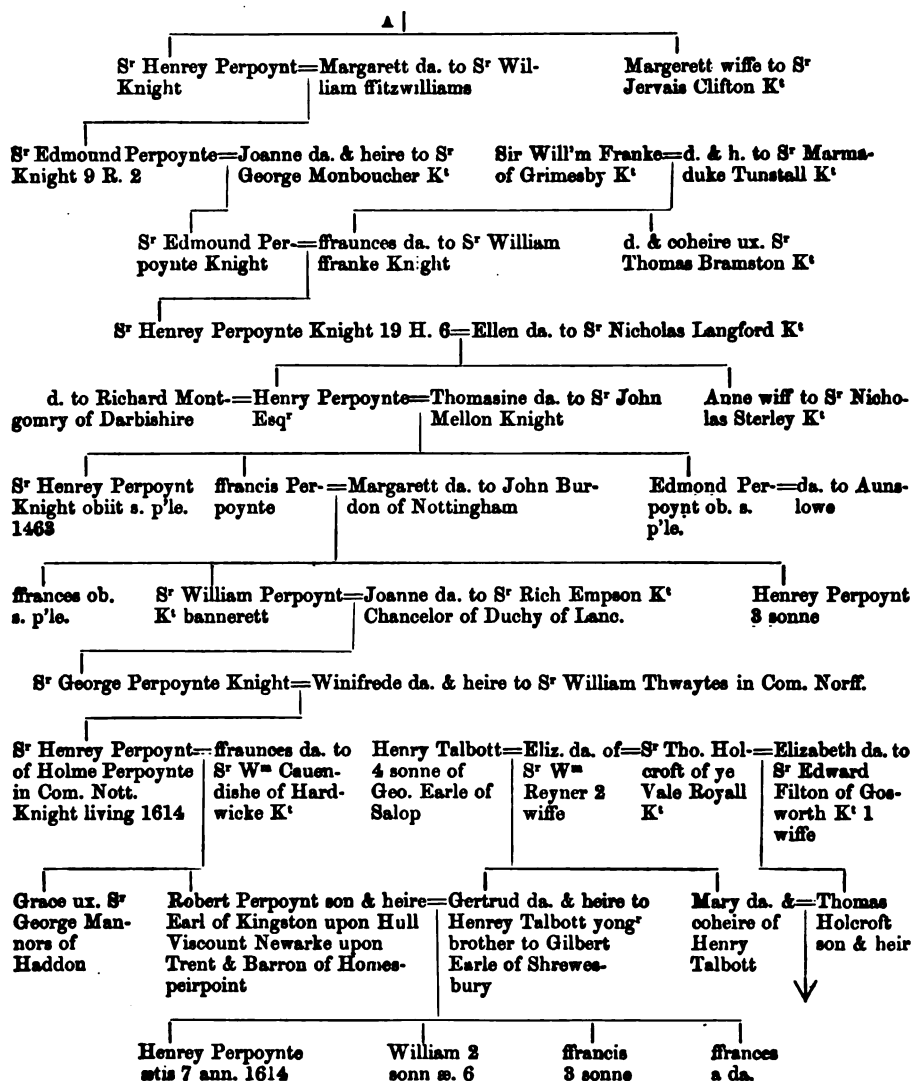

# Lassells.

ARMS. *Quarterly*:—1. Argent, three chaplets gules. 2. Azure, two bars or, on each three martlets (omitted in Harl. 1400) gules. 3. Argent, a chevron between three lions' heads erased gules. 4. Azure, three bucks trippant or. 5. Gules, a chevron between six cross crosslets, and in chief a lion passant or. 6. Per pale gules and sable a lion rampant argent, crowned or. 7. Azure, a bend between six estoiles argent. 8. Argent, three bars and in chief as many mullets sable. *The whole coat has a mullet for difference.*

CRESTS. 1. A buck's head argent. 2. Out of a coronet, a griffin's head<sup>s</sup> vert, beaked or, and charged on the neck with a mullet for difference. 3. Out of a coronet or, an eagle's head between two wings sable.

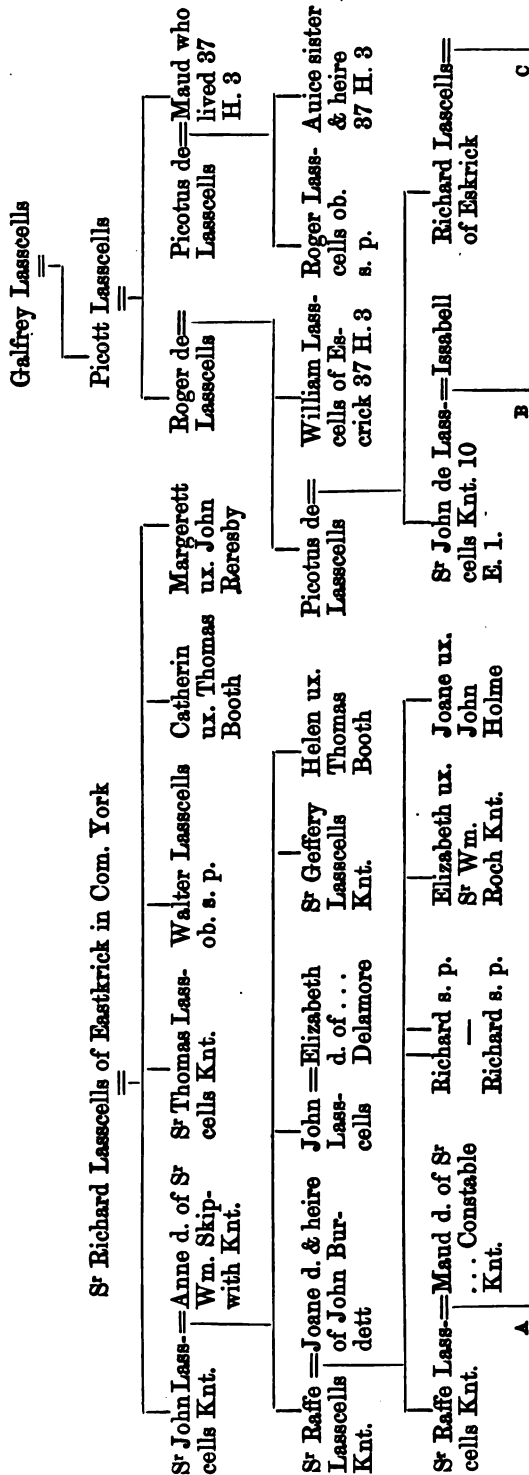

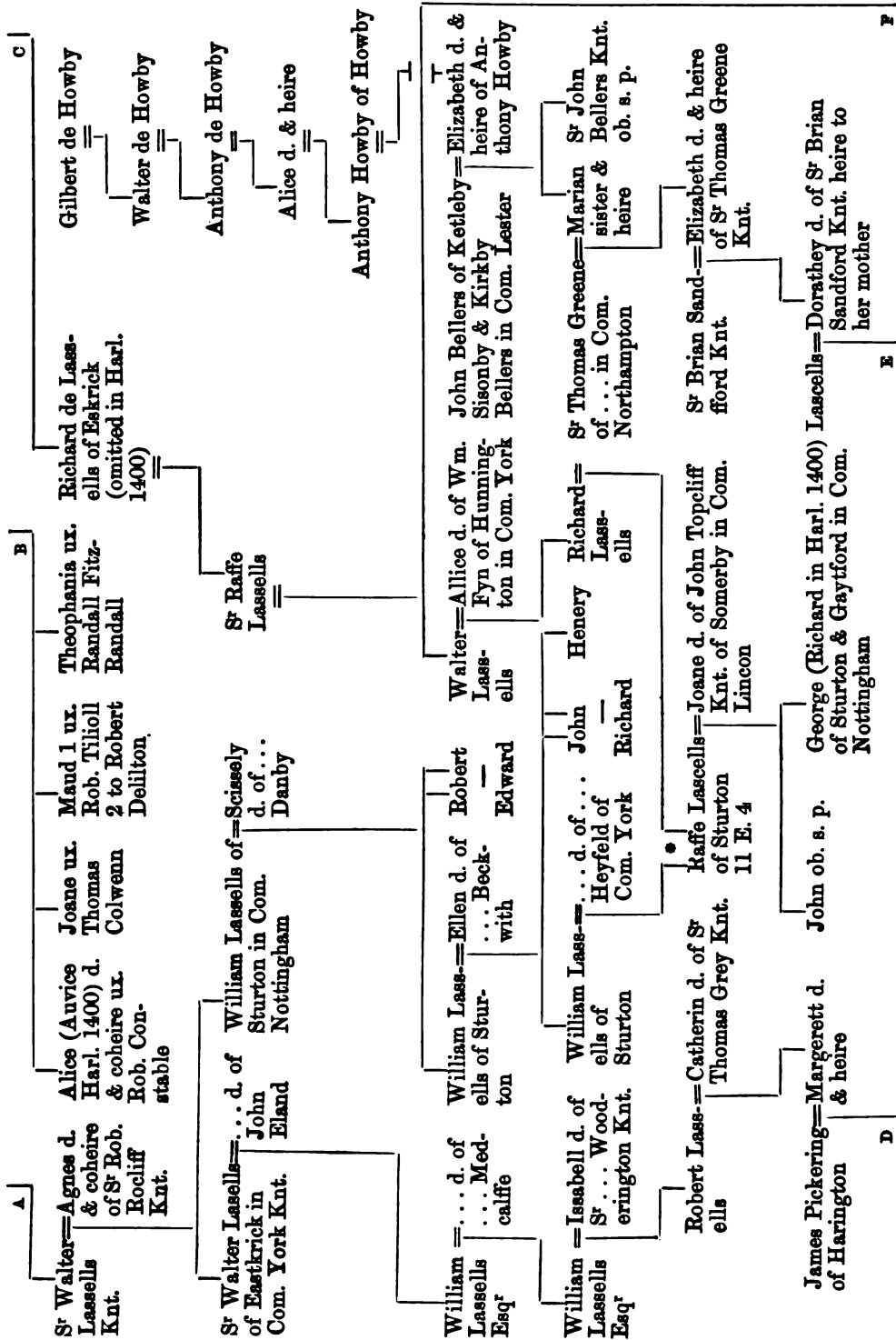



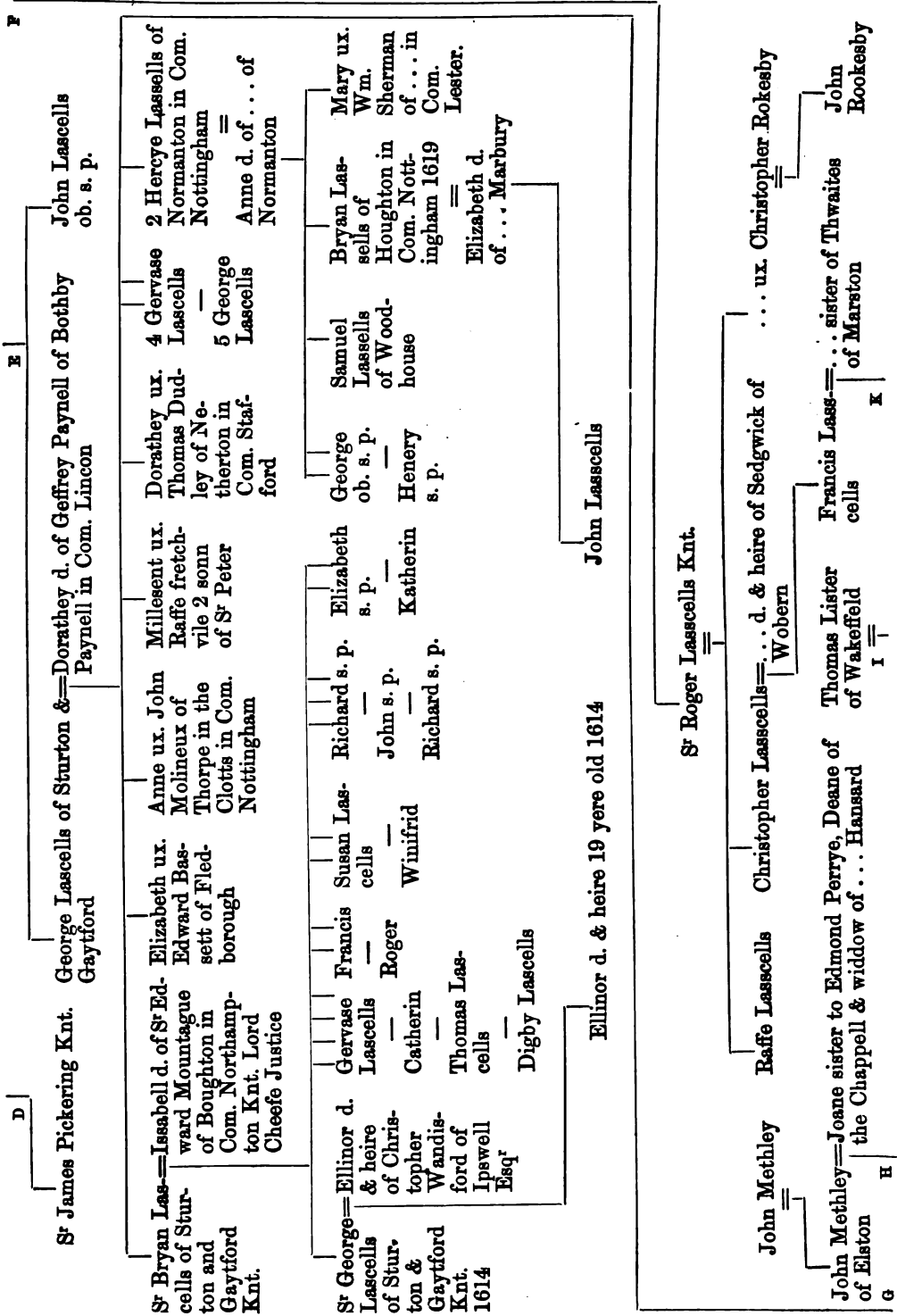

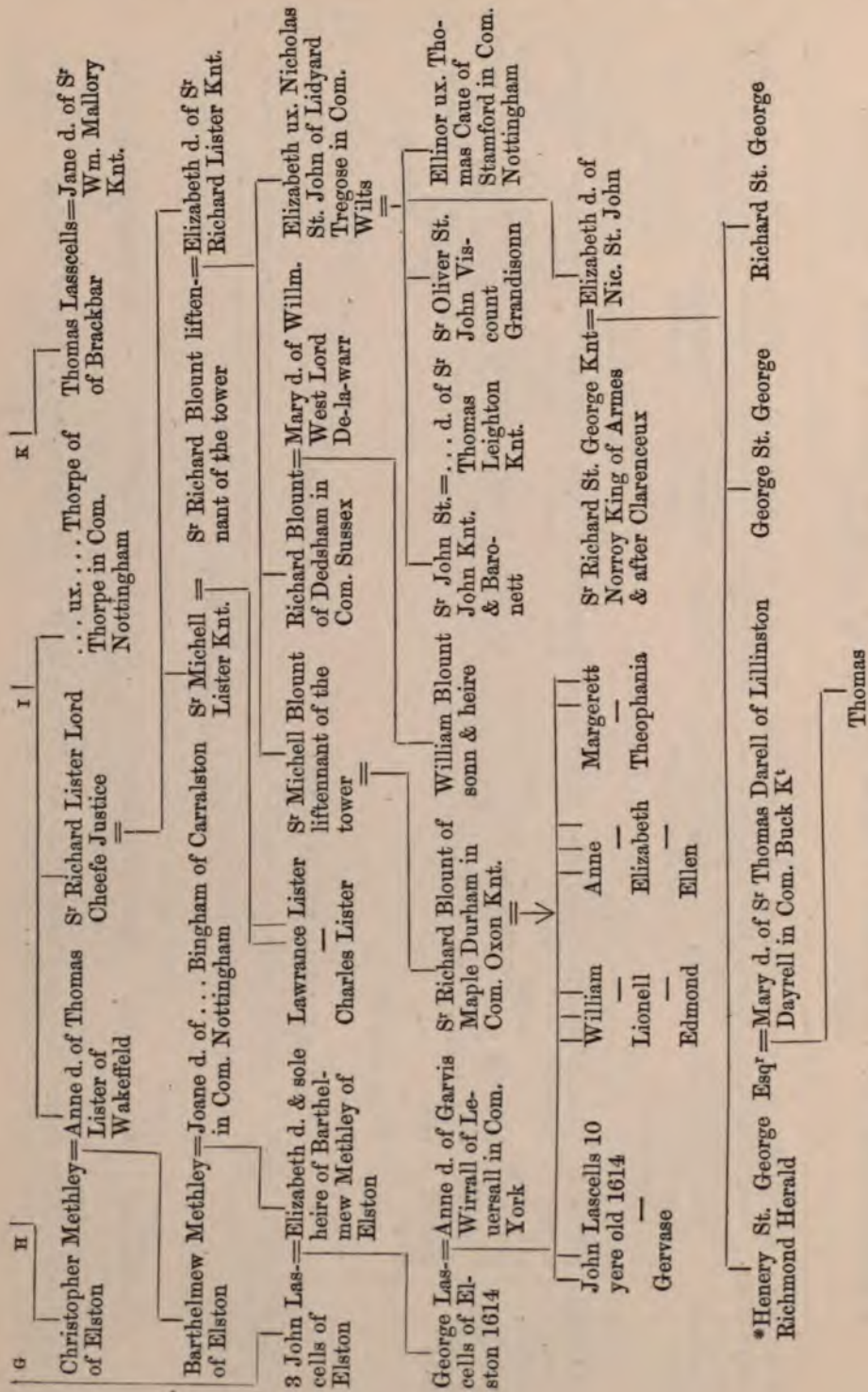

\* This Henery was knighted by the King of Sweden when hee carried the Garter over to the sayd king.

# Hollis.

ARMS. *Quarterly*:—1. *Ermine, two piles sable.* 2. *Argent, on a chevron between three cross crosslets sable as many crescents of the field.* 3. *Quarterly, argent and gules, on a bend sable three cross crosslets fitché of the first.* 4. *Sable, a crescent surmounted of a mullet argent.* 5. *Argent, a chevron gules between three men's heads sable.* 6. *Argent, three chevrons sable.* 7. *Gules, a chevron between three stumps of trees eradicated or.* 8. *Sable, a bend between two talbots passant argent.*  
 CREST. *A man's head coupé at the shoulders proper, wreathed about the temples argent and azure.*  
 MOTTO. SPREVA TAMEN VIUNT.

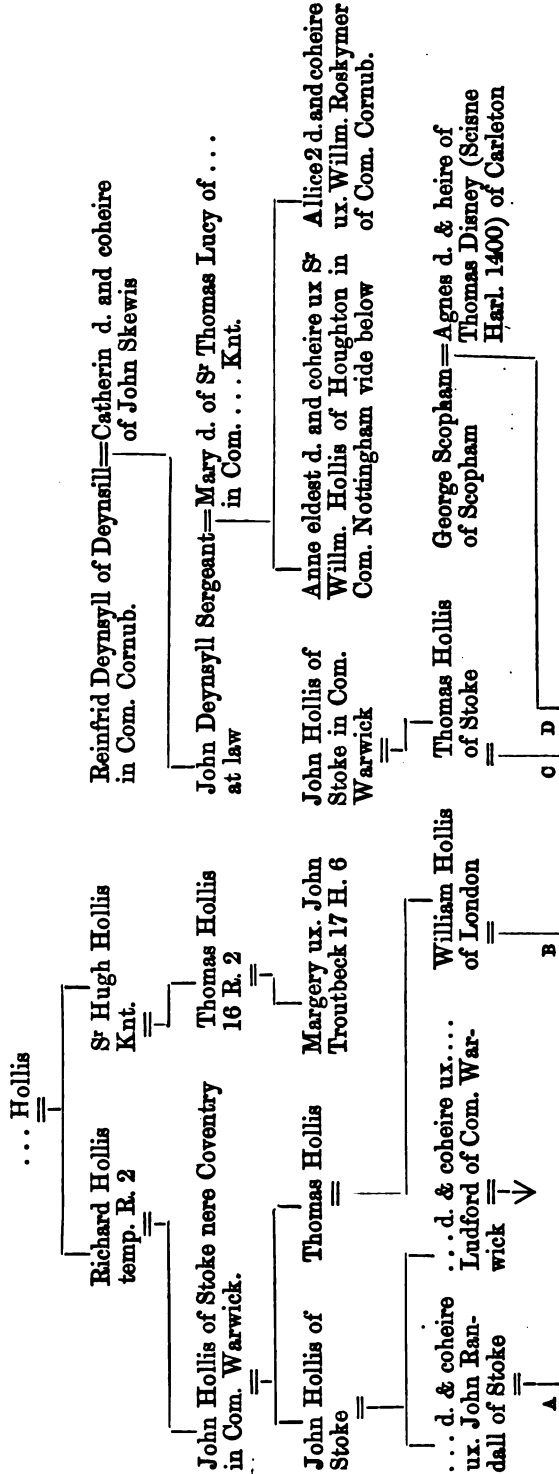

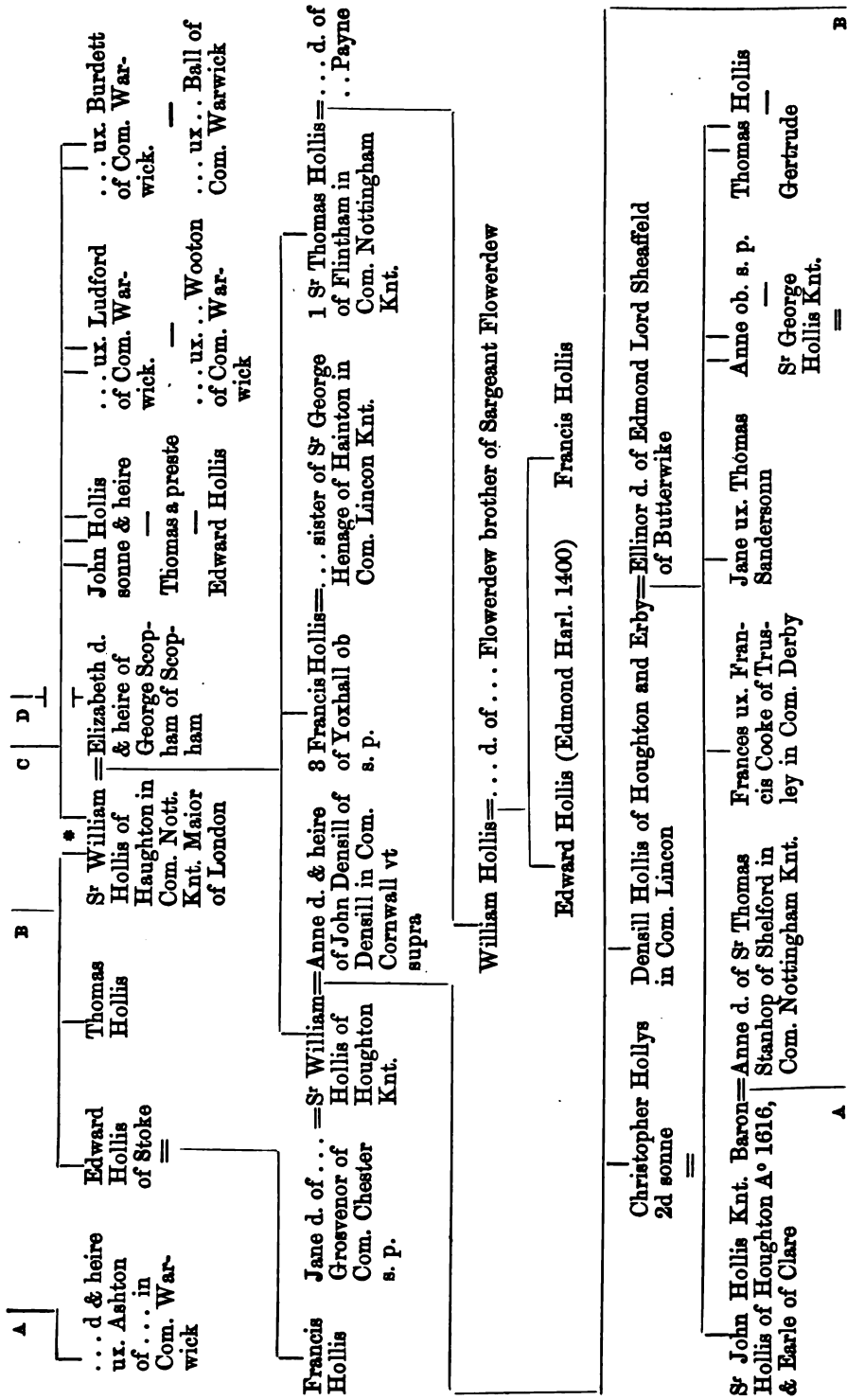

\* Sic in Harl. MS. 1555 ; in Harl. MS. 1400 he is only traced to Thomas Hollis of Stoke.

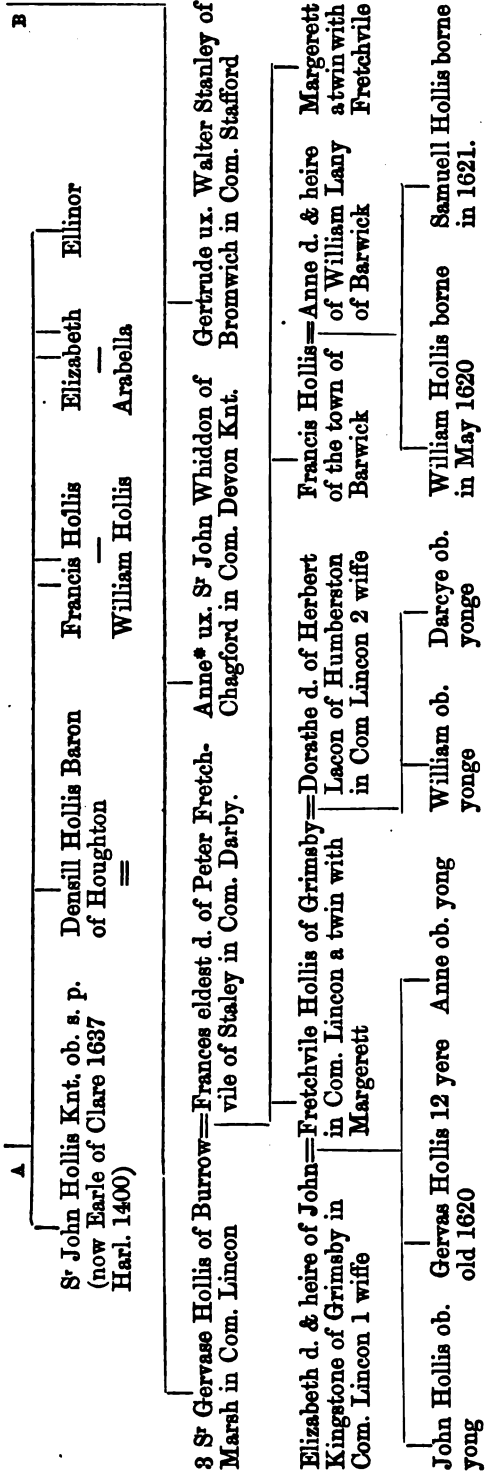

\* This Anne is made to die s. p. in Harl. 1400, and Anne wife of Whiddon, Justice of King's Bench, put in generation above.

## Nevell.

\* ARMS. *Quarterly* :—1. *Gules a saltire ermine*. RABY. 2. *Or, fretty gules, on a canton per pale of the first and argent a galley sable*. NEVELL. 3. *Gules, billettée and a lion rampant or*. BULMER. 4. ROWLSTON. 5. BLOMSTER. 6. FENCOTT. 7. CROFTES. 8. BOSVILE. 9. HERCYE.  
 CREST. *A bull's head ermine, the horns or, tipped vert*.

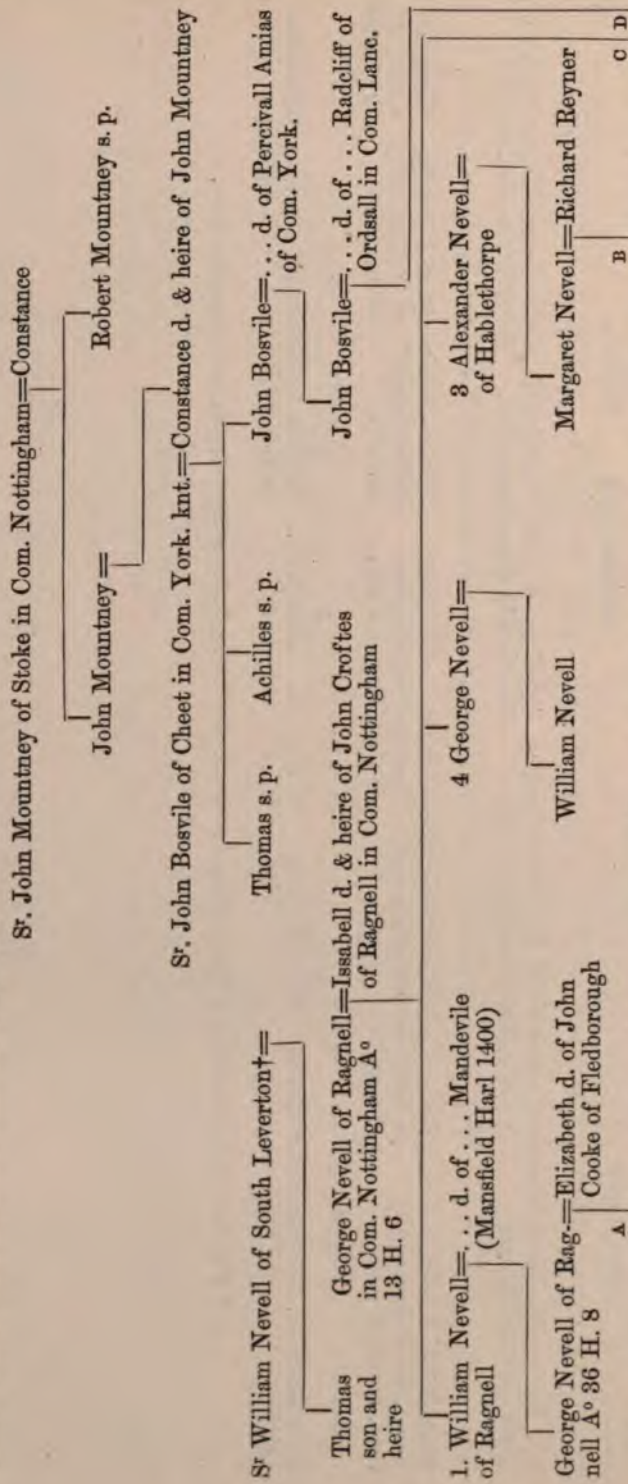

\* There is another shield Quarterly of 12, the first 8 quarters left blank. 9. Azure a bend between 6 martlets or. 10. Hercye. 11. Arches. 12. Leake. See pedigree of Hercy.  
 † William Nevell of South Leverton, Dunham, Rainell, & Winton in Com' Nott. did graunt the same to George Neull his sonne and Isabell his wife da. & heire to John Croftes of Rainell & to the heires of their two bodyes begotten A° 13 H. 6 (Harl. MS. 1400).

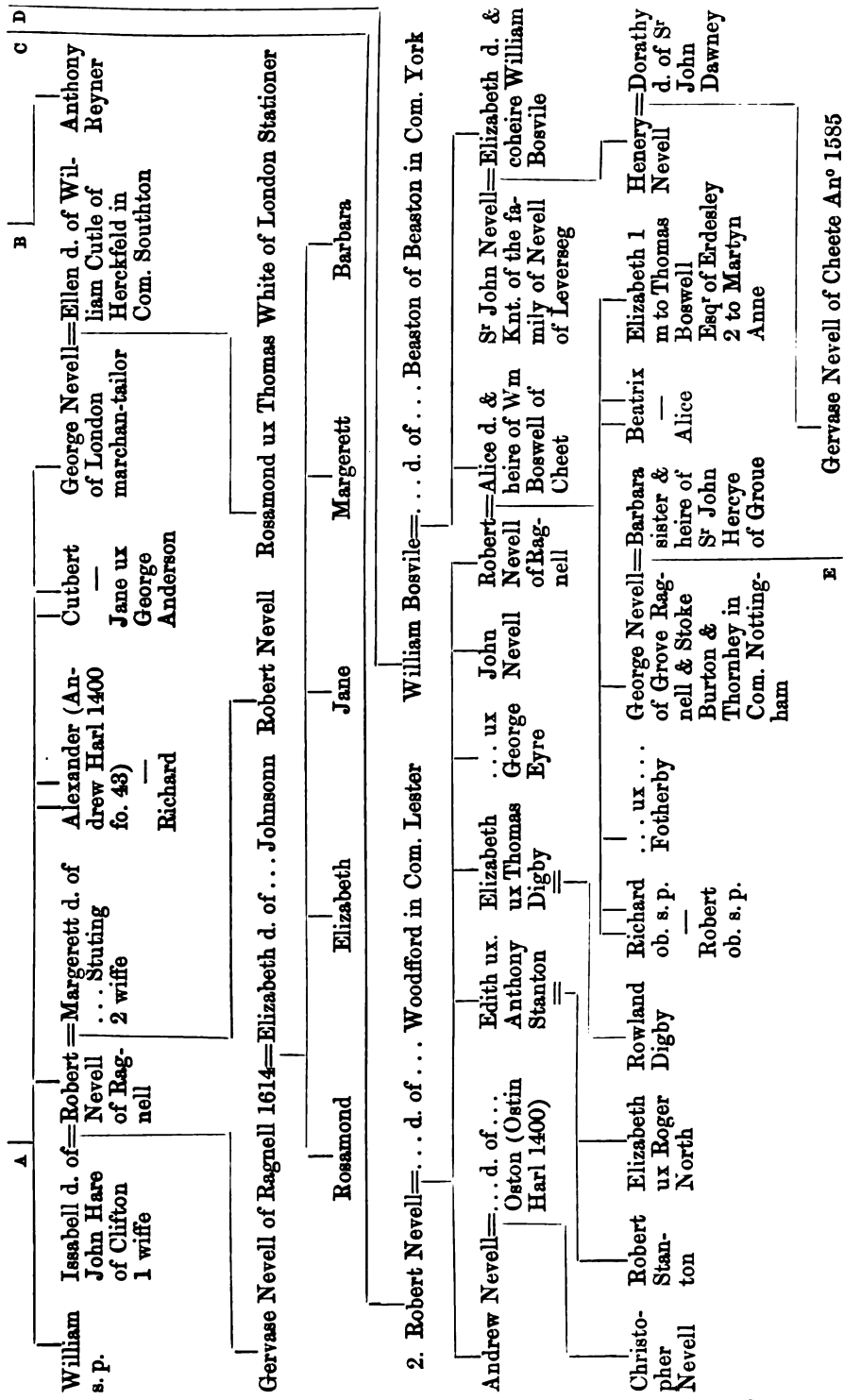

F

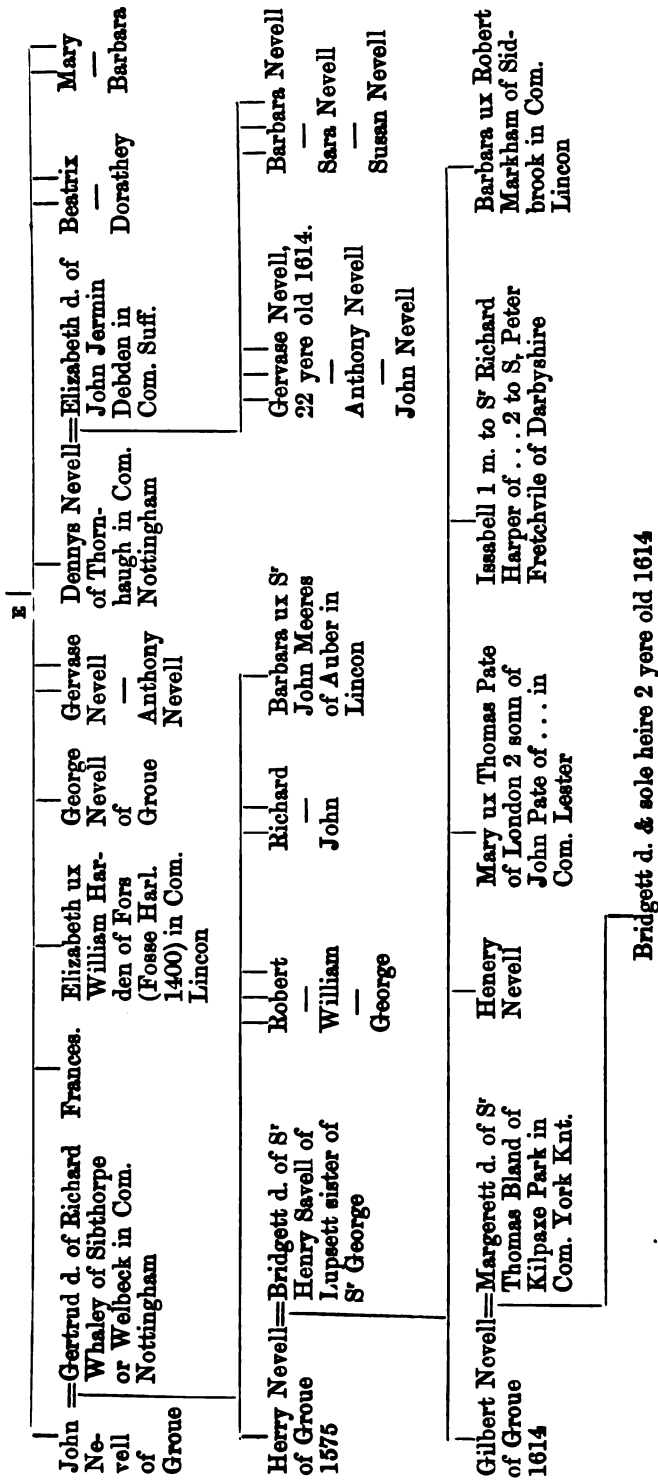



## Wastneys.

\* Sir William Gastneys Knt.

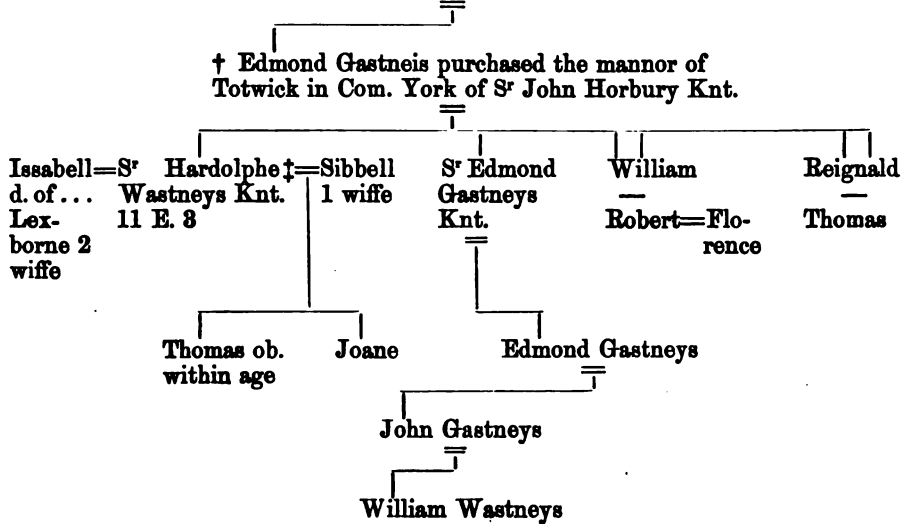

Sciunt presentes Robertus Wastnes dom's de Totewick et Hedon in the Clay cum aduocat' 24 E. 8 which manor of Hedon and Totewick with the aduowsons Hardolph Wastnes now of Heydon in the Clay in com. Nott and of Totwick in com. York now is possessed of 13 September 1614 but the other lands in Staffordshire above mentioned went by a match to Gresley in Staffordshire.

Ego Thomas de Gasteneys miles et Johanna uxor mea dedit Johannes de Gastneis fratri suo (nostro Harl. 1400) ad totam vitam suam vna messuagium &c. dat. An<sup>o</sup> 19 E. 8.

SEAL. An oval seal with arms, crest, helmet, and mantling. ARMS. A lion rampant. CREST. A lion's head erased and collared. Sig'um Johannes Gasteneys.

(Harl. 1400.)

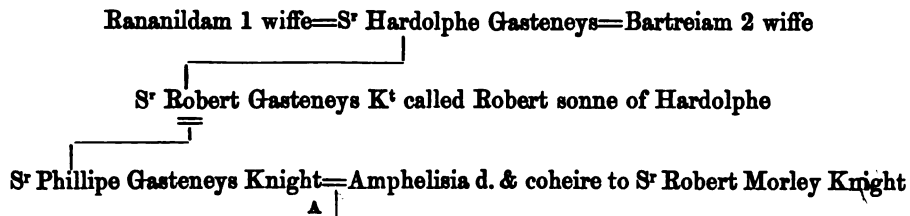

\* This S<sup>r</sup> William gave his lands in Derdburgh in com. Lester to his sonn Edmond.

† A charter granted by E. 1 to Edmond Gastneys in his manor of Totwick with the aduowson of the Church dat. 28 E. 1.

‡ A writt was directed to S<sup>r</sup> Hardolph Dewastneys inioyning him amongst the rest to come in person habere colloquium et tractatus of the West Biding in Yorkshire. Claus. in dorso An<sup>o</sup> 11 E. 8, 35.

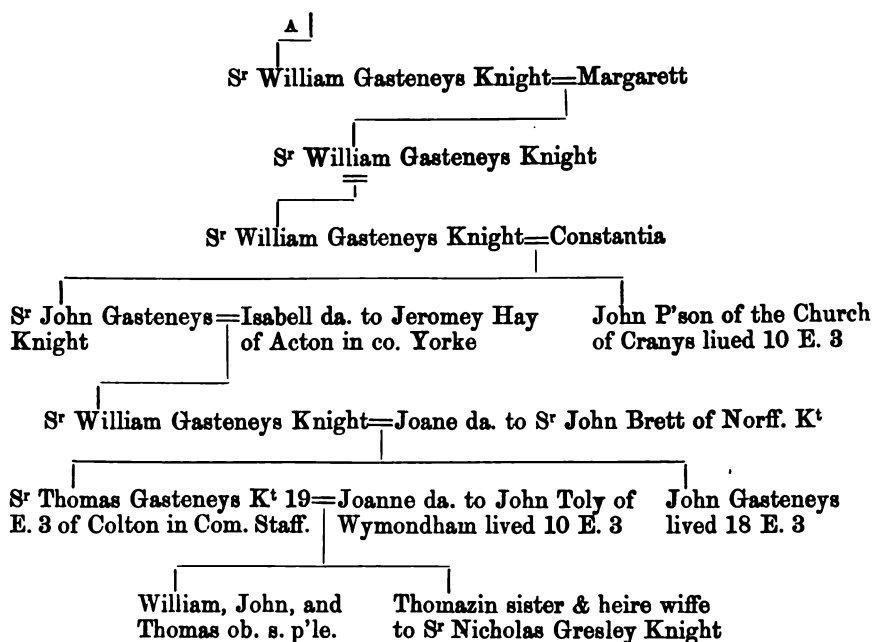

ARMS. *Sable a lion rampant double queued argent collared gules.*

CREST. *A demi-lion rampant double queued argent collared gules.*

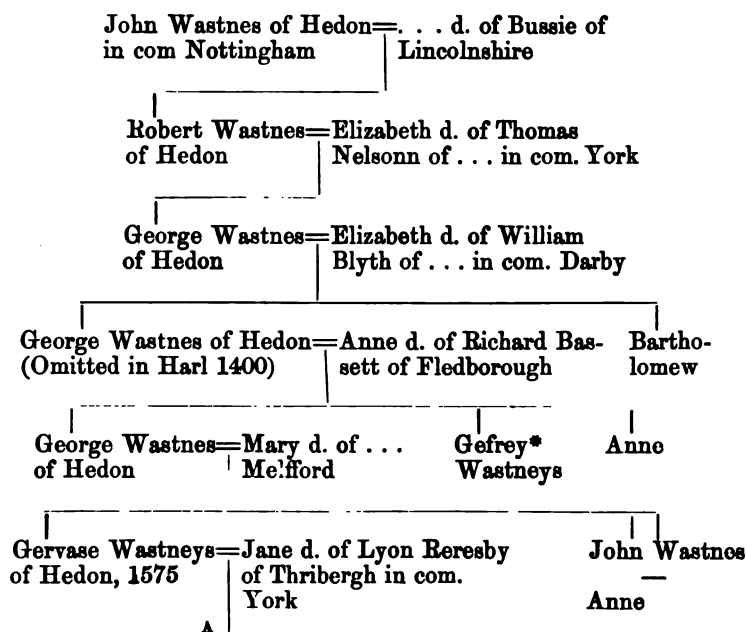

\* Made brother to Bartholomew Harl. 1400.

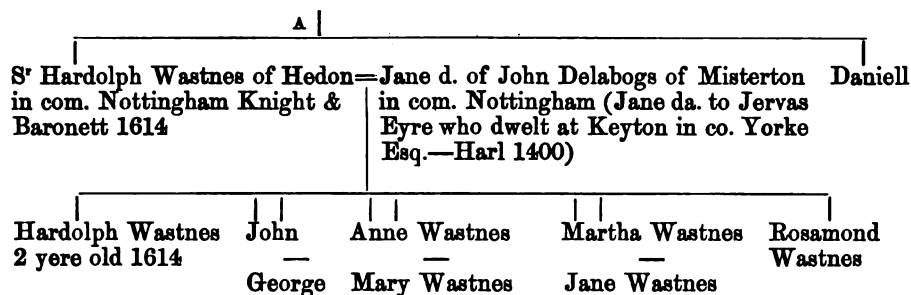

## Thornhegh.

**ARMS.** *Quarterly:—1 and 4. Argent, two annulets interlaced gules between three crosses patée sable. THORNHEGH. 2. Gules, on a canton argent a cross patonce azure. \*3. Or, a bend wavy azure between two lions passant guardant sable.*

**CREST.** *A tiger's head or, maned sable, gorged with a collar wavy azure.*

**CREST OF THORNHAUGH.** *A thorn-tree proper flowered argent, fructed gules, the seeds of the flowers or.*

Johannis Thornheigh vixit 2 E. 3=

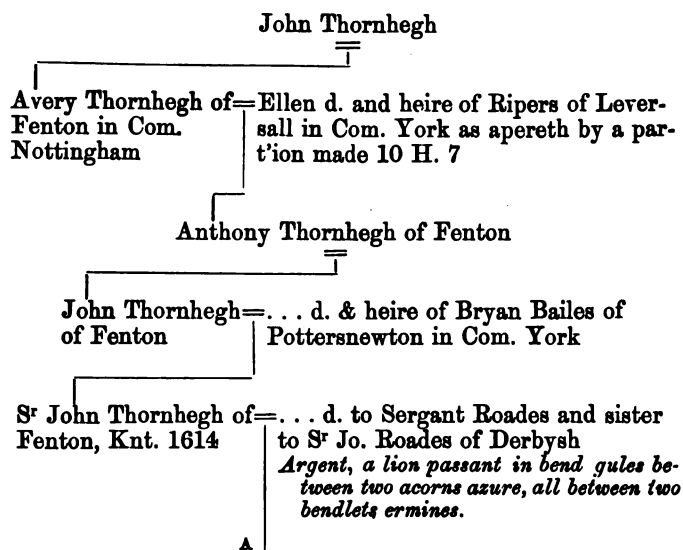

\* A Patent of the 3 coats and crest to Bryan Bailes of Potternewton in Com. York An. 21 of Q. Elizabeth by Norry Flower, viz. Or, a fess wavy B, between 2 Lyons passant gardant S, the crest a tigers hed cope or mayned sable a collar wavy B.

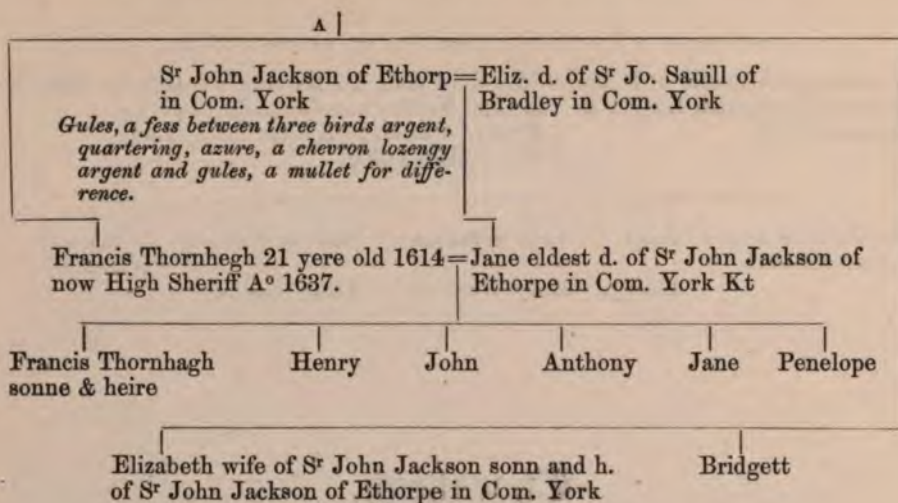

## Cranmer.

ARMS. *Quarterly:—1 and 4. Argent, on a chevron azure between three pelicans sable as many cinquefoils or. 2 and 3. Argent a fess fusilly gules, on each fusil an escallop or.*

CREST. *An eagle's head erased russet, the neck pierced with an arrow or flighted and barbed argent.\**

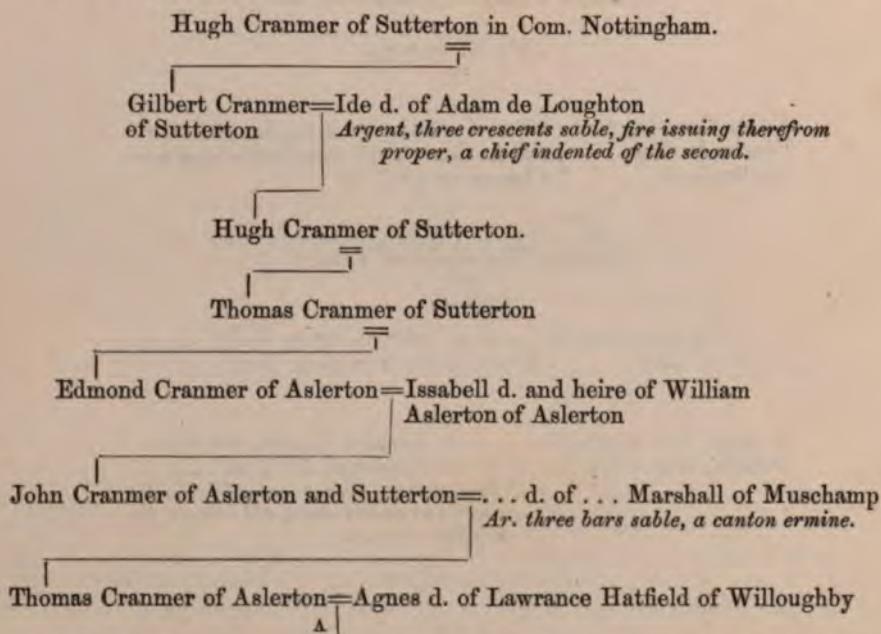

\* In the margin near above crest is tricked; A cock's head erased sable wattled and jellopped gules. "Cranmer's crest of Watton in Nottingh'm bearing the two coates quarterly."

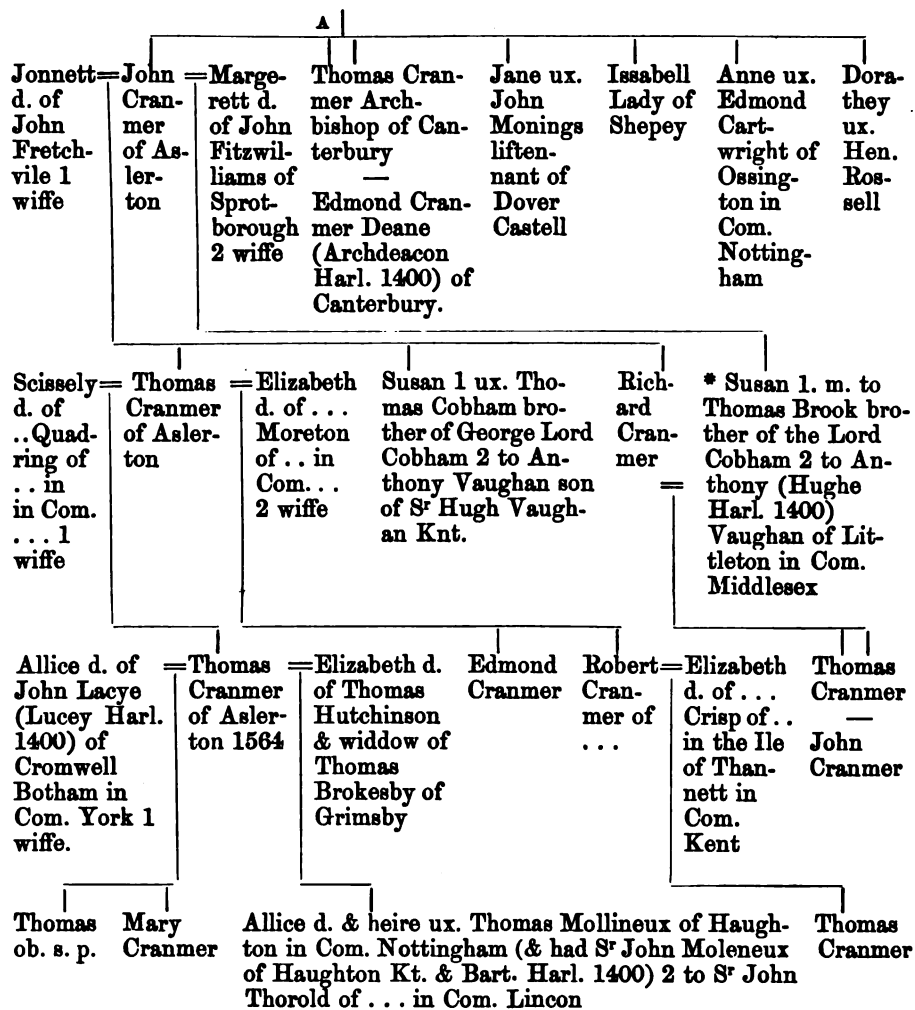

\* Thus entered in Harl. 1555, but put only as issue of John C. & M. Fitzwilliams in Harl. 1400, where she is stated to have had issue by Brooke, Thomas Brooke of Chislet Parks, and by Vaughan, Hughe and Alice.

**Molineux.**

ARMS. Quarterly:—1 and 15. Azure, a cross moline or, a bordure argent. 2. Gules, a lion rampant argent crowned and within a bordure engrailed or. 3. Gules, six lions rampant argent, three, two, and one. 4. Or, three leopards' faces sable. 5. Argent, a hart lodged proper attired or. 6. Argent, a fess gules between three birds vert, beaked, legged, and collared of the second. 7. Azure, semée of fleurs-de-lis and a lion rampant guardant argent. 8. Vert, a lion rampant argent. 9. Argent, a cross and in the first quarter a fleur-de-lis sable. 10. Argent, on a bend engrailed sable three hunting horns of the field. 11. Barry of eight argent and gules, a label or. 12. Sable, a chevron between three mullets and a bordure argent. 13. Argent, on a chevron azure between three pelicans sable as many cinquefoils or. 14. Argent, a fess fusilly gules, on each fusil an escallop or.

CREST. A plume of peacocks' feathers proper.

There is another coat, Molineux without the bordure quartering 2, 3, 4, 5, 6, 7, 8, and 9, a crescent for difference.

Sr Richard Molli.—Joane d. of Gilbert Hadock and widow of Peter Leigh (Ellen da. to Sr Wm. Harington of Horneby Kt. Harl. 1400)

John Cotton = Janne da. to of Ridware in Nicholas Com. Staff. Fitzharbert

Richard Mollineux of Sefton

Elizabeth d. of Sr Robert (John = Thomas Mollineux of Haughton = Catherine d. of Sr John Harl. 1400) Markham of Cotton in Com. Nottingham one of the Priue Counsell to H. 7 ob. 6 H. 7 Attorney-General to E. 4

Robert Mollineux = Dorathey d. of Thomas Powtrell of West Hallom in Com. Darby

Elizabeth ux. Stephen Hatfield & widow of ... Beckard

2 Anthony Mollineux Doctor of Divinity Parsonn of Sefton ob. 5 Q. Mary

Thomas ob. s. p.

Richard = Mollineux of Houghton

Margaret d. of Edmund Bussy of Hether (Hever Harl. 1400) in Com. Lincon

Anne ux. Rob. Veale ux. ... Hough

Elizabeth ux. William = Mollineux

Catherin ux. Stephen Hatfield

Margaret ux. George Warren

C

B

A

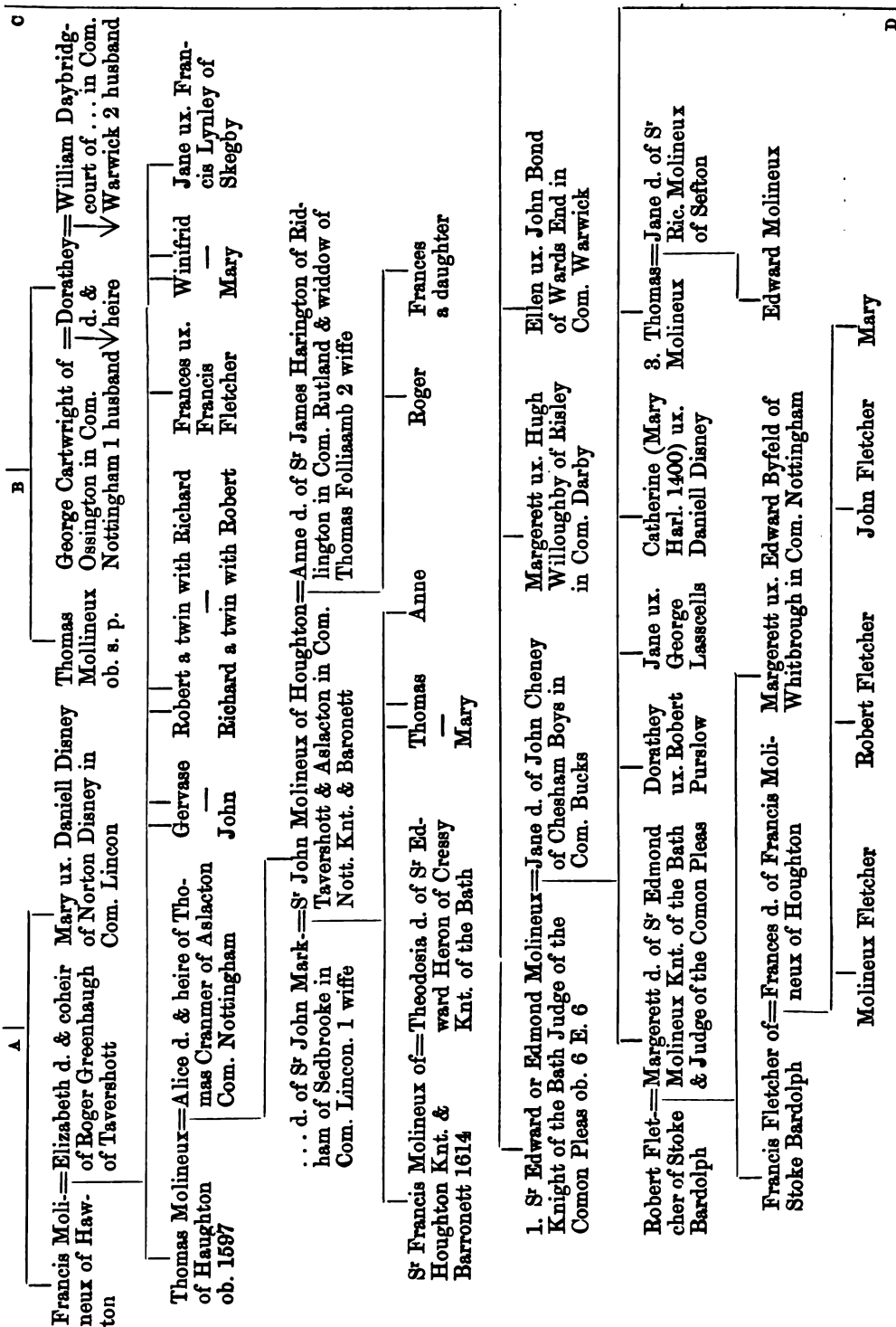

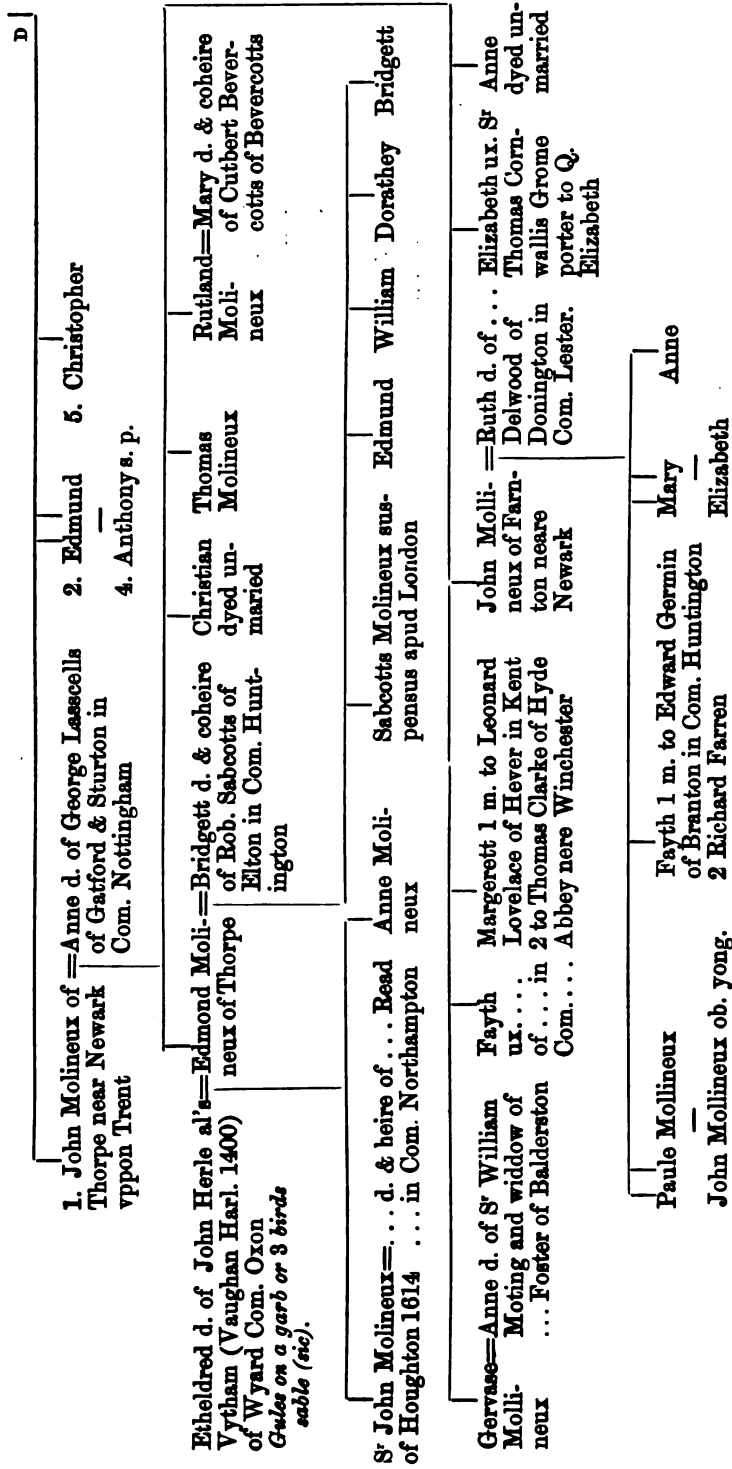



## Odingsells.

Placita de term<sup>o</sup> Paschæ A<sup>o</sup> 32 H. 6 rot 328 dorso.

Ichington longa } Warr.  
Ecclesia.

Hugo de Dodingselles temp E. 2

Johannes qui inde feofaut Joh'em Has-  
lauke militem qui inde feofaut quosdam.

Johannes Dodingselles=Emma

Hugh Lindsey lived in the time  
of King W<sup>m</sup>. the Conqueror

Johannes Dodingselles

Allen de Lindsey  
Lord of Bradwell  
and Woluerley

Johannes Dodingselles temp E. 3

Johannes Dodingselles

Galfrey de Lindsey Lord=Amicia  
of Bradwell and Maxtock  
in com. Warwick

Edwardus Dodingselles  
nunc petens A<sup>o</sup> 32 H. 6

Galfrey de Oding=  
sells Lord of Max-  
stock

=Brasill d. &  
coheire ma-  
ried 20 H. 2

David de Lindsey a Scott=Alice d. & heire

William  
Odingsells

Gerrard Oding=  
sells 38 H. 3

=Lucey d. of ...  
Beresafford

David Lindsey

Alice married to Hen-  
ry de Pinkney

Henry de Pinkney

Robert de Pinkney

Hugh Oding=  
sells 16 E. 1

Rowland Odingsells of Long Ichington=  
in com. Warwick

=Lucey da.  
to Bruce

John Odingsells 10 E. 3=Luce

John Odingsells 24=  
yere old 27 E. 3

=Amicia d. of Rob. (Roger Harl.  
1400) Carbett ob. 34 E. 3

Edmond Odingsells  
22 E. 3, 1347

S<sup>r</sup> John Odingsells Knt.=Alice d. of S<sup>r</sup>  
16 yere old 3 E. 2

John St. John

A

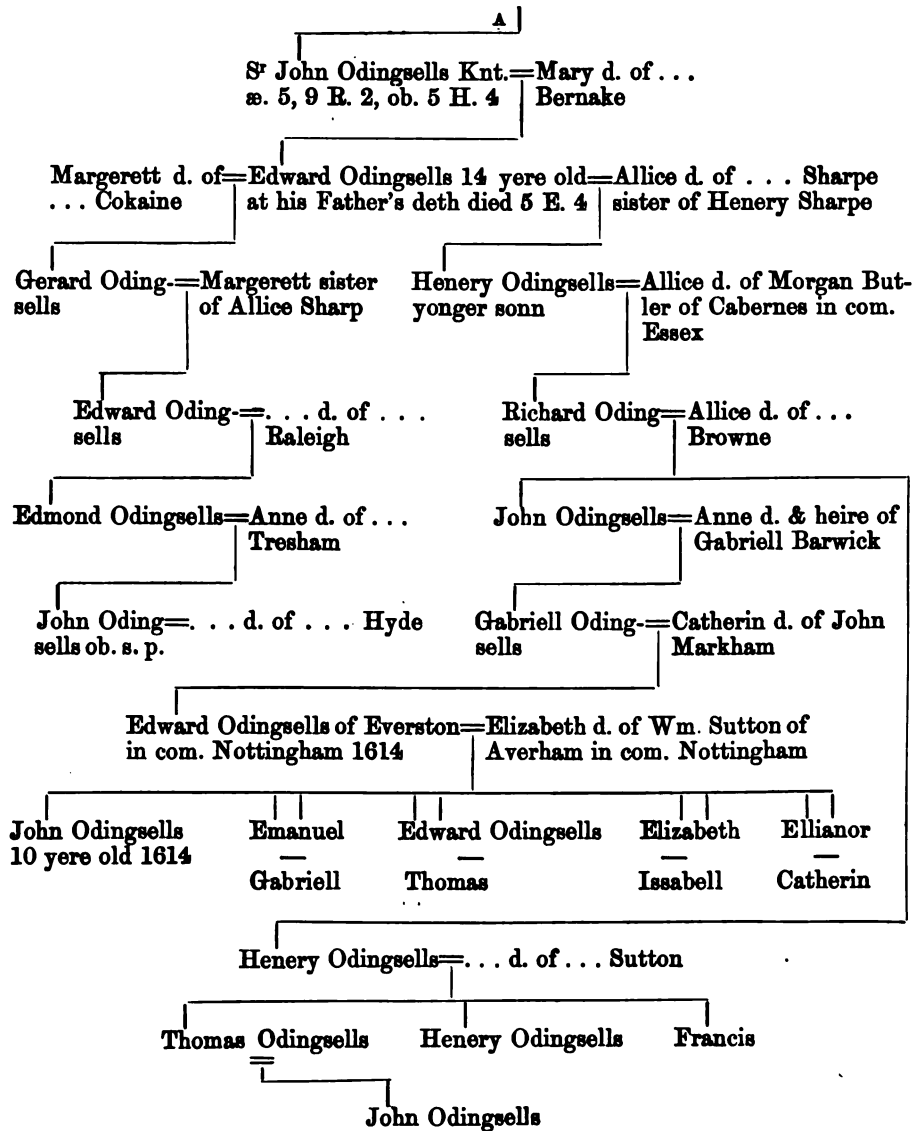

Omnibus xpi fidelibus hoc scriptum visuris vel auditoris amicia relicta dn's  
Johannis de Odingsells Dn's de longa Ichington noueritis me memisisse totam ius  
meum in Expuston in com. Nott. A<sup>o</sup> 29 E. 3.

SEAL. *A fess and in dexter chief a mullet, impaling, two bars and a canton; with  
this crest, a fox passant, collared and chained.*

## Ayscough.

ARMS. Quarterly:—1. *Sable, a fess or between three asses argent.* AYSCOUGH. 2. *Or, a bend azure.* CAYTHORP. 3. — *a saltire gules, and on a chief of the last three escallops argent, a crescent sable for difference.* TALBOYS. 4. *Gules, a cinquefoil within an orle of cross crosslets or.* HOMFFREYVILLE. 5. *Gules, a chevron between ten cross crosslets or.* KYME. 6. *Gules, two bends or.* 7. *Azure, a cross chequée argent and gules.* CORNFELD. 8. *Gules, two chevrons and a bordure or.* CHANNELL. 9. *Sable, a chevron between three columns or, a label argent.* BOLLINGBROOK.

CREST. *An ass's head erased argent.* (Both coat and crest are charged with a mullet for difference.)

John Ascough of Colling in Co. Lincon Esq.

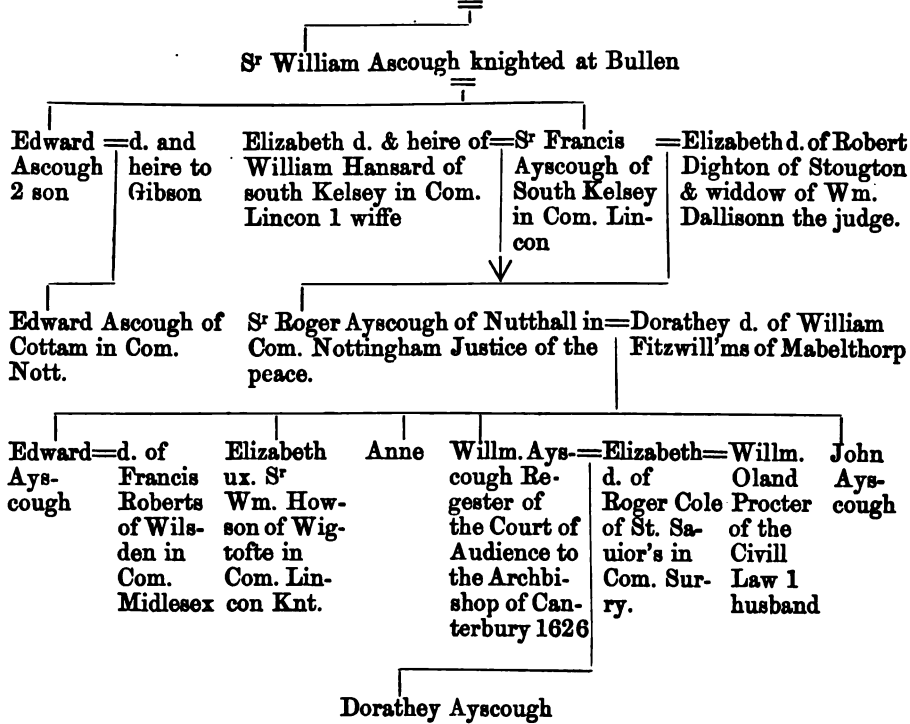

## St Andrew.

Johannes de St. Andrea obiit sestitus de terras in Hinxtun=Johanna superstes  
et Armigton in Com. Cantabrid' A<sup>o</sup> 34 E. 3 An<sup>o</sup> 34 E. 3

|  
Johis de St. Andrea ætatis 22 an    Edmondus St. Andrea heres  
et amp. ob. 43 E. 3                    fratris ætat. 7 Ann.

CANTABRIGIA { Ivo de St. Andrea dat demidiam marcã pro vna assisa  
                          { capienda coram Nicholaio de Turri An<sup>o</sup> 46 H. 3

Paganus de St. Andrea temp H. 1=Crueburga

|  
Thomas de St. Andrea

|  
Henericus de St Andrea An<sup>o</sup> 10 Regis Joh'is  
Placit. de banco Com. Buck. pro manerio de  
Stainsly An<sup>o</sup> 10 Johis Rot. dorso 1.

S<sup>r</sup> Saiher St. Andrea Knt=Maud d. & heire of William Diue

|  
S<sup>r</sup> Roger St. Andrea Knt.    S<sup>r</sup> Robert de St. Andrea Knt.    James de St. Andrea

|  
Roger de =Maud    S<sup>r</sup> Roger de St. =Agnes d. of S<sup>r</sup> Richard Grey of Sandiacre  
St. Andrea        Andrea Knt.        Knt. & had in mariage the mannor of Bifeld

|  
Richard St Andrea=Alice d. of Richard Stoke of Stoke nere Coventry

|  
S<sup>r</sup> John St. Andrea Knt.=Julian d. of Robert Zouch of Lubthorpe Knt.  
*Seven mascles conjoined 3, 3,  
& 1, a label; impaling, 10  
roundles 4, 3, 2, & 1.*

|  
Robert St. Andrea=Catherin d. of . . . Maulley of Sutton    John St Andrea

|  
Thomas St. =Elizabeth d. of Peter Poole    John St.    Elizabeth  
Andrea        of Radborne        Andrea        Andrea

|  
Peter de St. Andrea

|  
John St. Andrea=Alice

|  
William St. =Margerett d. of    Edmond  
Andrea        . . . Aston                    Hugh

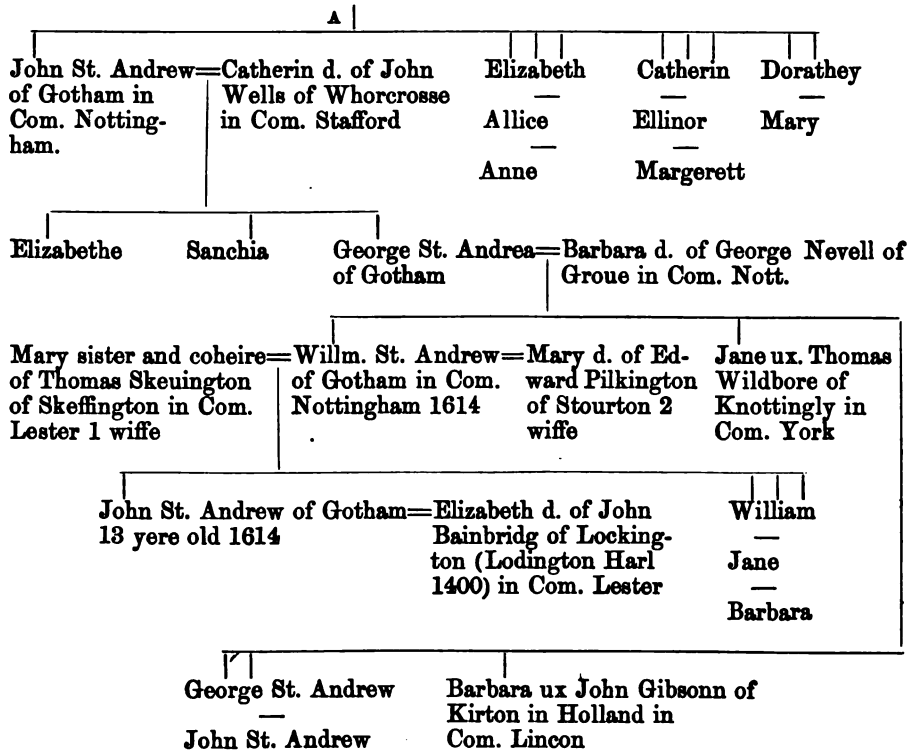

Ex chartis Willm. St. Andrew de Cotham in Com. Nottingham.  
An<sup>o</sup> 1614.

Sciant p'ntes et futuri q'd ego Margereta de Quincy Comitissa Winton' dedi &c. in legitima viduitate mea postquam feci homagium meum D'no Regi Henrico filio Regis Joh'is Seihero de St. Andrea pro homagio et seruitio suo centu' solid' terræ meæ de Crokeston et Kerdinton cum multis natiu's et eoru' sequelis &c. et si forte warrantizare non potero dabimus et escambiu' ad valenham in loco competenti de hæreditate mea in Anglia. Testibus Will'mo de Knapwell tunc Seneschallo meo, Euerardo de Trumpington, Odinello de Albiniaco, Rogero de S'c'a Andrea, Rado' Neuill, Barthlo' filio Will'mi, Will'mo de St. Georgio, Briano Forestario, Alexandro de Witeby, Will'mo Falconario, Henrico Forestario, et aliis (Harl. 1555, fo. 64 b.)



Ex chartis Will'mi St. Andrew de Gothan in Com. Nott. Arg' A° 1614

Sciant p'ntes et futuri quod ego Matildis de Se'o Andrea in ligea [sic] viduitate mea dedi et concessi etc Laurentio de Sancto Andreo filio meo tota' t'ram quam habui in villa de Erington\* vna cum manerio d'cæ' t'rae d'co Laurentio et hæred' suis habend' etc. eid' Laurentio et hæred' suis excepto Judaismo et domo religionis pro vna libra cinimini, Testibus D'no Henrico Childerle, D'no Joh'e de Musgrose, D'no Hugone de Dokesworth militibus.



Jacobus de S'ca Andrea fil's D'ni Saiheri de S'co Andrea concessit Rogero filio D'ni Rogeri de S'co Andrea totu' ius in manerijs de Hadton in Com. North'ton Gatham in Com. Nott. Armigston et Henxston in Com. Cantabr. et Sheffend in Com. Essex. Sans date.



Anno regni R'g Hen' filij Regis Joh'is 55 in aula D'næ Matildis de S'co Andrea apud Gatham coram Do'no Petro Picoth et multis aliis facta est hæc conventio inter Rogeru' de S'co Andrea antenatum dictæ Matildis de S'ca Andrea matris suæ et D'num Will'mum Perpetuum Vicarium Eccl'ie de Rodington Joh'em Capellanu' de Kemurth et nobilem ancillam de Rametianam filiam D'ni Thomæ filij Will'mi Executor' D'næ Albridæ la Walesch relicta quondam D'ni Rob'ti de S'co Andrea militis, etc; vizt. quod dictus Rogerus nomine matris suæ dimisit d'cis executoribus d'cæ D'næ Albridæ totu' manerium de Gatham secundu' formam contenta' in scripto q'd D'ca D'na Matildis de S'co Andrea concessit D'no Roberto de S'co Andrea filio suo. Dat' A° 55 H. 3.

Sciant p'ntes et futuri quod ego Rogerus de Quincy Comes Winton' Constabu-

\* Erington est in Com. Cantabridg.

larius Scotiae dedi Roberto de S'co Andrea filio Seiheri de S'co Andrea pro homagio et seruitio suo cent' solid' sterlingoru' Annuatim recipiend' de par presenta de firma mea de Brackley etc. Hijs testib' D'no Will'mo Maudit, Will'mo filio suo, Ernardo de Bosco, Ernaldo filio suo, Rado' Bassett de Draiton, Rado' filio suo, Seihero de S'co Andrea, Philippo Louell, Will'mo de Bosco, Warino de Tunderley.

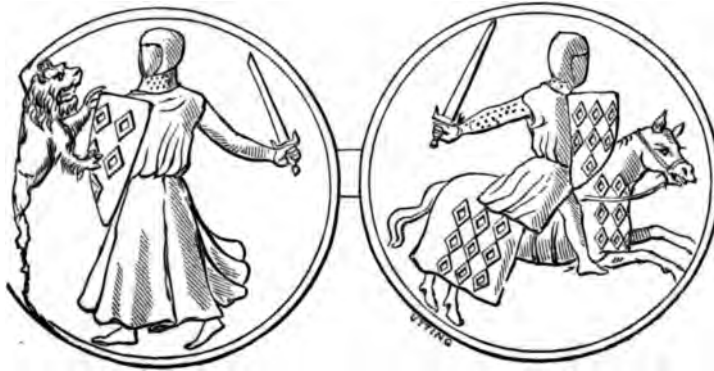

**North.**

ARMS. *Argent, two chevrons between three mullets sable.*  
 CREST. *A lion's head erased, argent collared vairé or and azure, the collar ring gold. In the Visitation made 1614 this moderne coat and crest per W.M. SEAGAR norroy 42 Q. Elizabeth 1600 for NORTH of Walkeringham.*  
 ALSO *On a chevron between three escallops, as many catherine wheels. (THE AUNTIAN COATE.) And Quarterly:—1. and 4. Azure, a lion passant or between three fleurs-de-lis argent. 2. Argent, on a bend sable three wolves (?) passant of the field. 3. Sable, on a chevron between three pheons argent, as many mullets gules. (LORD NORTH.)*

Roger North of Walkeringham in Com. Nottingham

Roger North of Walkeringham

Thomas North of Walkeringham in Com. Nottingham

Roger North of London Marchant Haberdasher buried at St Michells-in-the-Queerne London

Roger North of Walkeringham

Thomas North of London=Christian d. of Richard Warcop of St. Nicholas nere Appleby in Kent.

Edward North of Wal=Edward North of Walkeringham 1614

Alice ux John Quarles of . . . in Com. Hertford

Charles North of Walkeringham 1614

Elizabeth ux. Audeley vel Atherley quere whether (Aderley Harl 1400)

Judeth ux. Thomas Tuke

Thomas North Edward North

Mary ux. Francis Thornhill

Elizabeth ux. Thomas Foster of Smawes in Com. York

Charles North 2 yere old 1614

Edward North

A



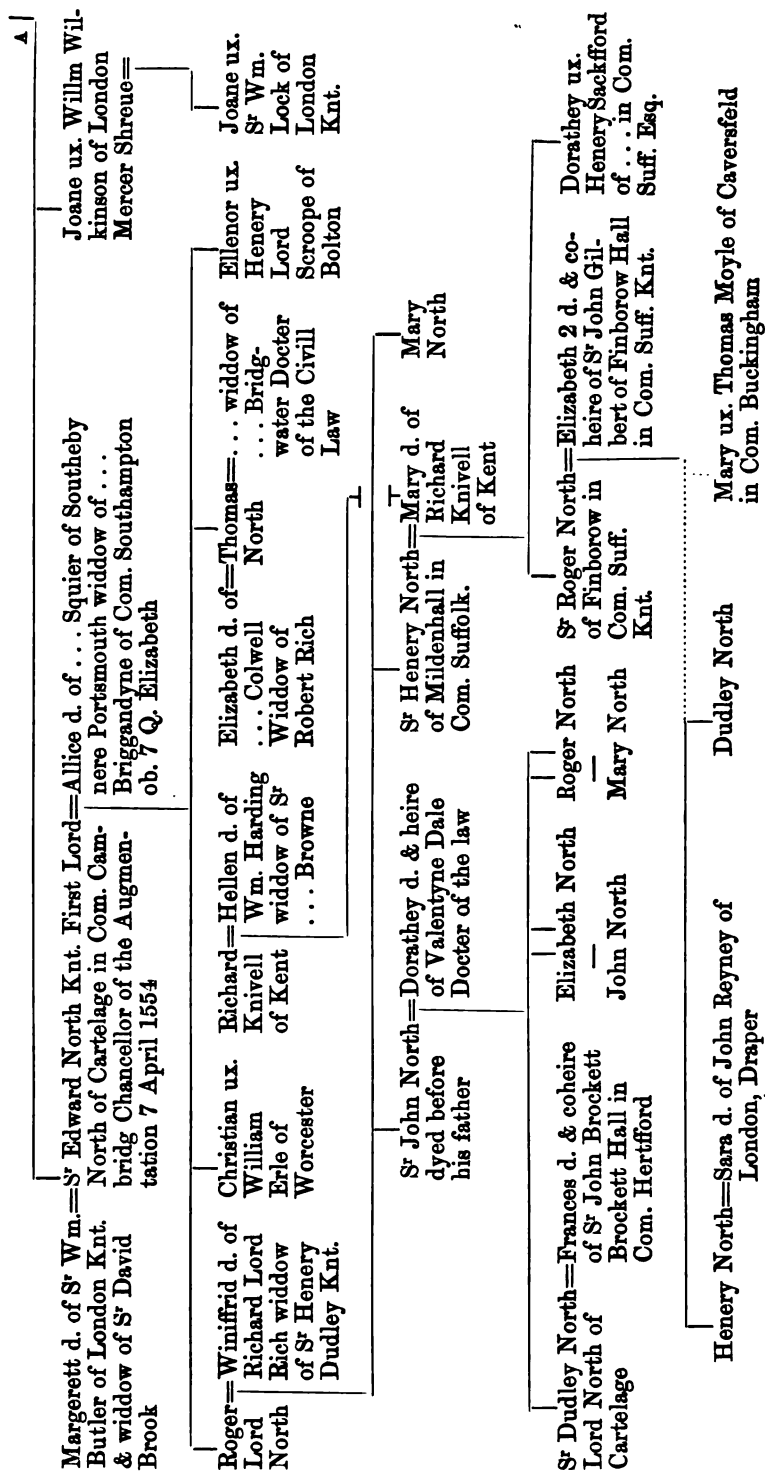

## Tate.

ARMS. *Per fess or and gules, a pale counterchanged, three cornish choughs proper.*

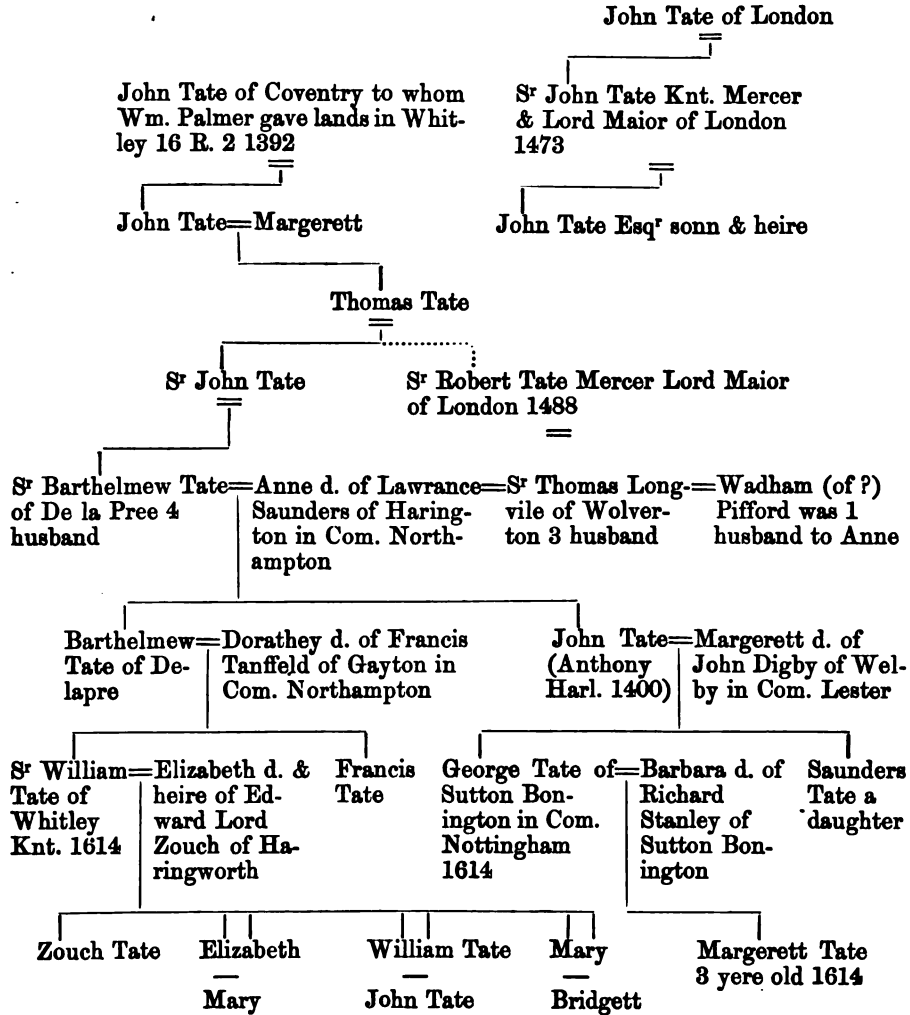

## Tong.

ARMS. *Quarterly:—1 and 4. Azure, a bend cotised argent between six martlets or, a mullet for difference. TONG. 2 and 3. Argent, a fess fleury counter fleury or, between three escallops sable. ILLINGWORTH.*

[Not quartered in the Visitation in the office.]

CREST. *A cubit arm, vested argent, in the hand proper an anchor fessways or.*

John Tong of Maningham = . . . d. of . . . Thornton of  
in Com. York | Thornton in Com. York

▲

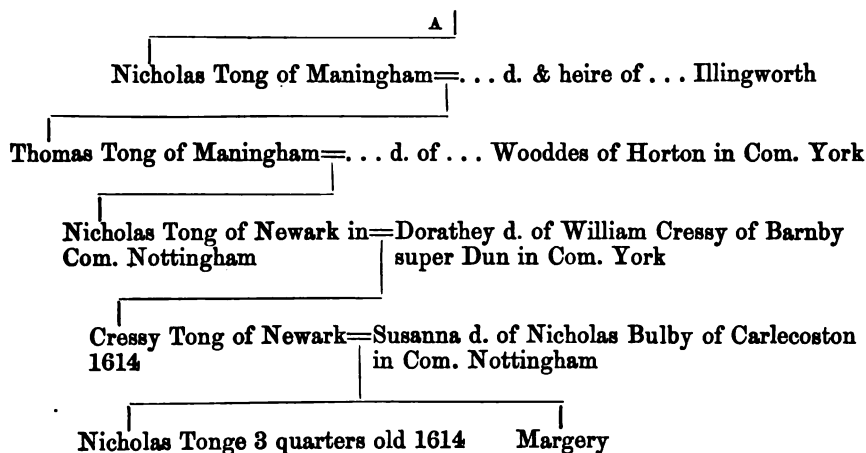

## Stringer.

**ARMS.** *Per chevron sable and or, in chief two fleurs-de-lis of the last, and in base an eagle displayed of the first.*

**CREST.** *A griffin's head erased vert, gorged with a coronet argent chained or.*

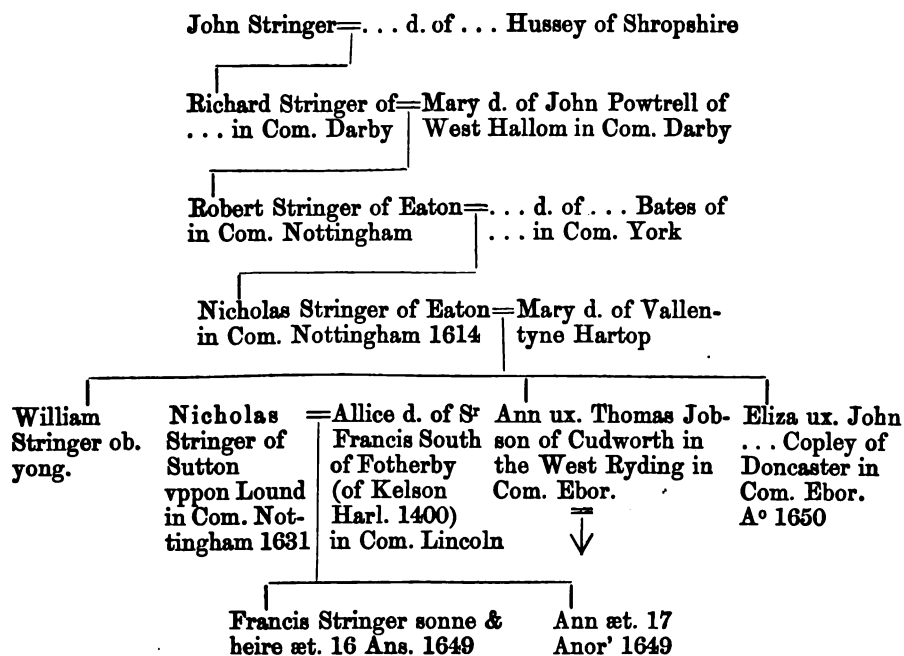

**WOOD.**

**ARMS. Quarterly:**—1. *Gules, semée of cross crosslets fitché, and three demi-woodmen argent, on a canton sinister azure three fleurs-de-lis or.* WOOD. 2. *Argent, a pelican in her nest vulning herself sable.* CHANTRELL. 3. *Gules, on a fess argent three crosses pattée of the field.* SLORY. 4. *Gules, three fusils conjoined in fess argent and in chief two cinquefoils or.* COLWICK.  
 [Noate that the last Coate is not quartered in the Visitations of this County in the office.]

**CREST. An oak tree proper, acorned or.**

The Augmentation of the Canton in the firste Coate was given by Clarenceux Harve for taking of a frenchman as I have scene under the hand of Dethick but there was but too Coates quartered viz. the first & third see the pellican was left out.

Sr Thomas Wood Knt. Lord Cheefe Justice of the Common Plees= . . . d. & coheire of Thomas Delamare (of) Delamare

Elizabeth d. & heire ux. Sr Thomas Stewkley of Aston in Com. Devon Knt.

This Sr Thomas Wood quartered the two first coates of Wood of Lamley but without the Canton.

Vltima Voluntas Johannes de Slory de vetri Lafford Composita An<sup>o</sup> Dom. 1452 31 H. 6  
 SEAL. On a fess three crosses pattée. SIGIL JOHAN SLORY DE VETRI.

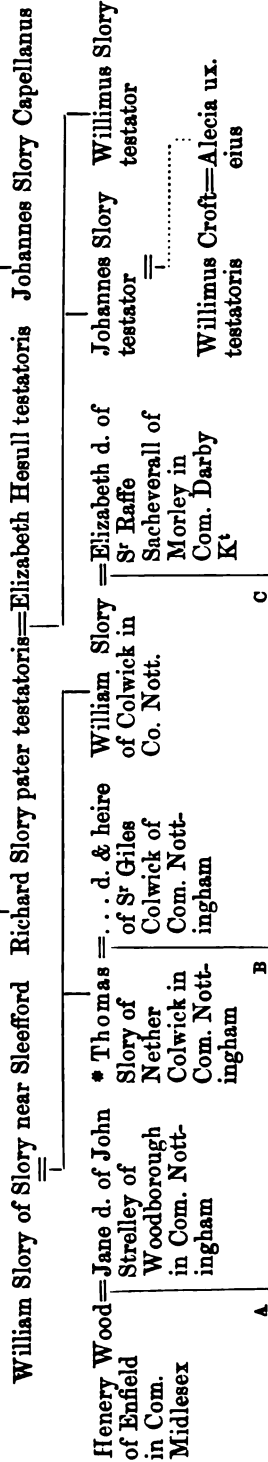

\* This Thomas Slory married one of the daughters & heires of Sr Giles Colwick by whome he had Nether Colwick & Sr John Byrons Ancestors married another of the daughters by whome hee had Over Colwick and afterward Robert Wood Esq<sup>r</sup> wch married Margerett d. of Sr Edward Mountague Knt. souldé Nether Colwick to Sr John Byron Knt,

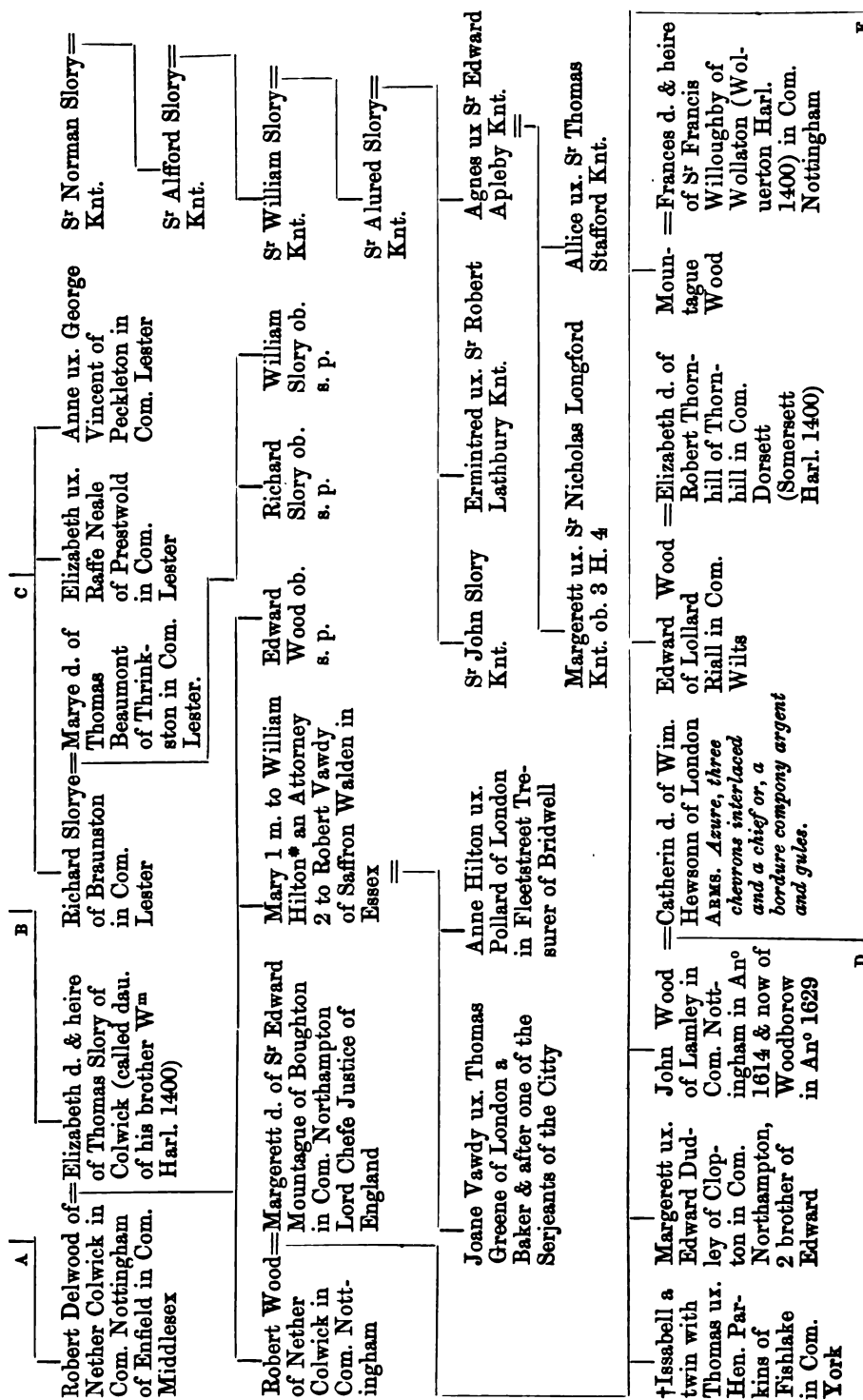

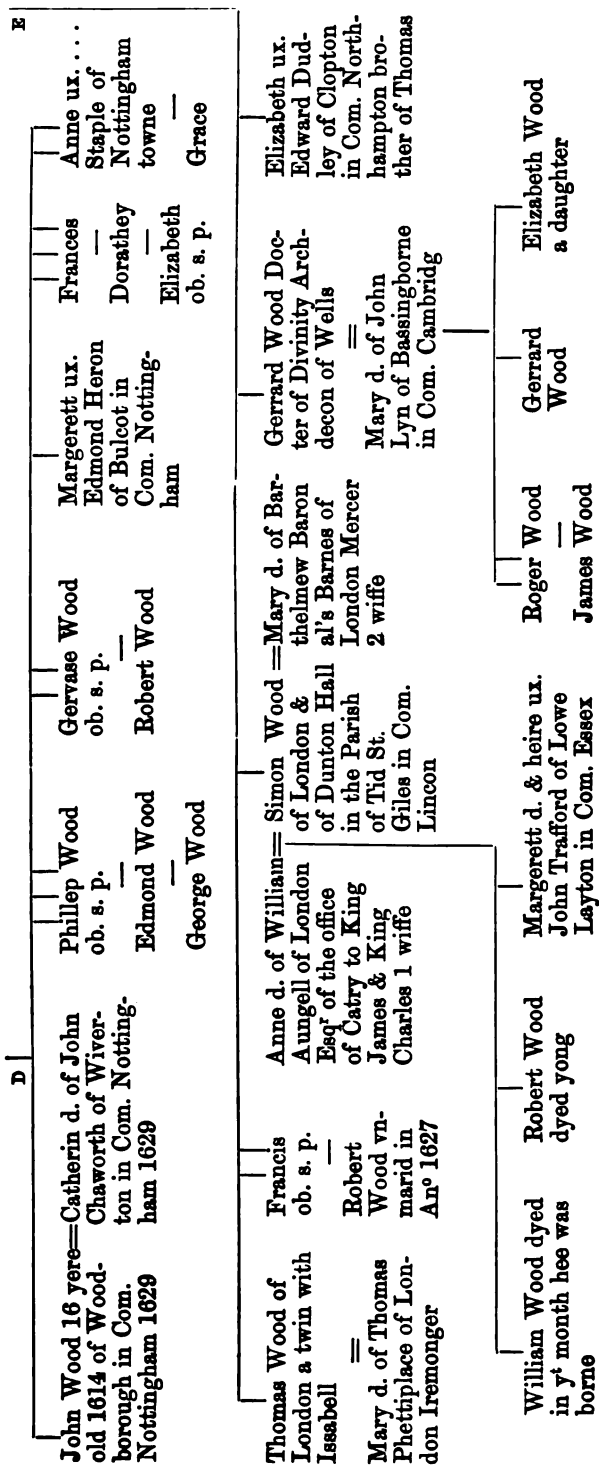

## Stretton.

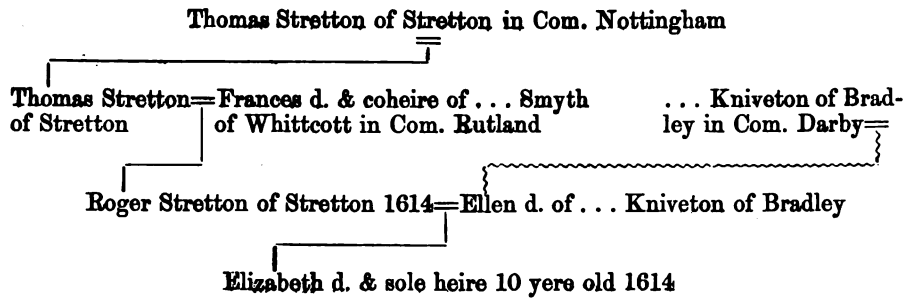

## Bland.

ARMS. *Argent, on a bend sable three pheons or.*

CREST. *Out of a coronet or a leopard's head proper.*

Both coat and crest are differenced with a martlet.

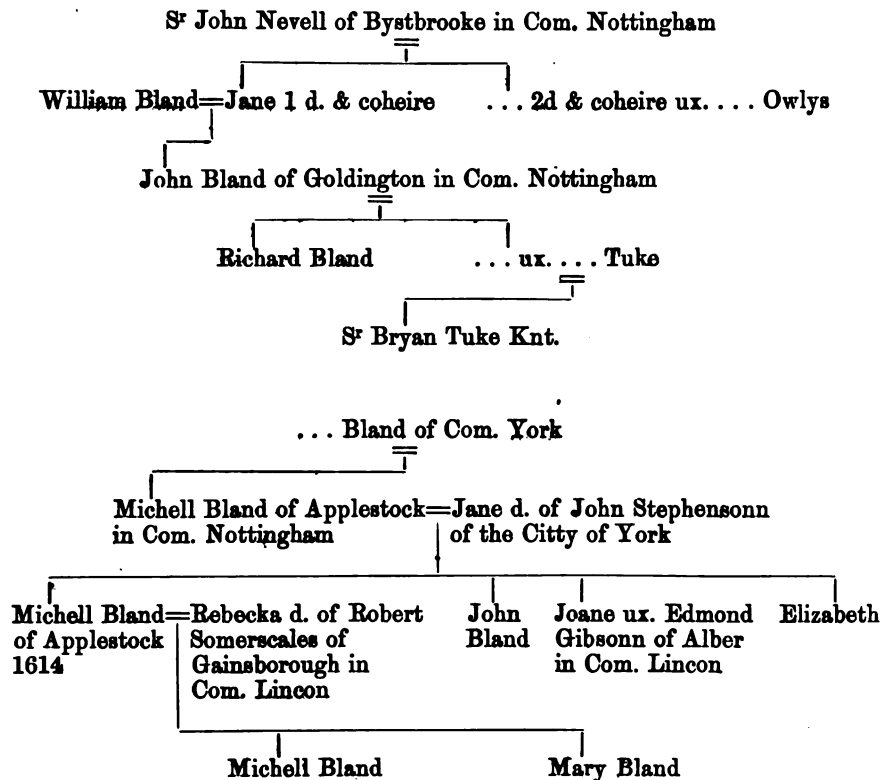

## Darrell.

ARMS.\* *Quarterly*:—1. *Azure, a lion rampant or crowned argent and charged on the shoulder with a trefoil sable, a crescent for difference.* DARELL. 2. *Or, a chevron between three cinquefoils gules.* CHICHLEY. 3. *Argent, on a chevron gules between three hunting horns sable stringed or as many mullets gold.* HORNE. 4. *Azure, a lion rampant or crowned and within a bordure argent.* DARELL OF PAGHAM IN SUSSEX. 5. *Argent, a fess fusilly sable.* KNOTSWORTH. 6. *Argent, three lions' heads erased gules.* DENMAN.

CREST. *Out of a coronet a Saracen's head wreathed round the temples argent and azure, on the head a cap of the last fretted of the second turned up ermine and having a tassel or.*

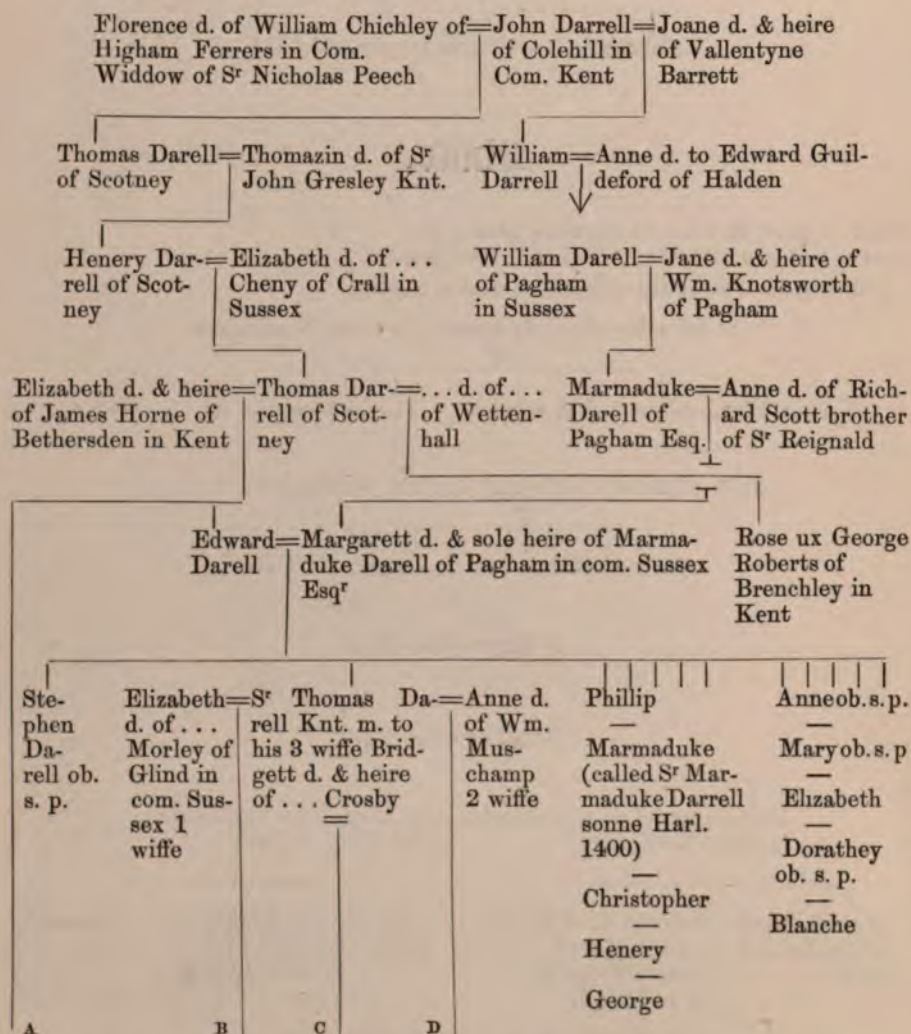

\* In Harl. 1400 the arms are drawn quarterly of four, 1, 2, and 3 as above, 4 chequé argent and gules a cross azure, a shield of pretence (blank). The cap of the crest is not turned up ermine and the wreath round the head is or and azure. The coronet is marked or.



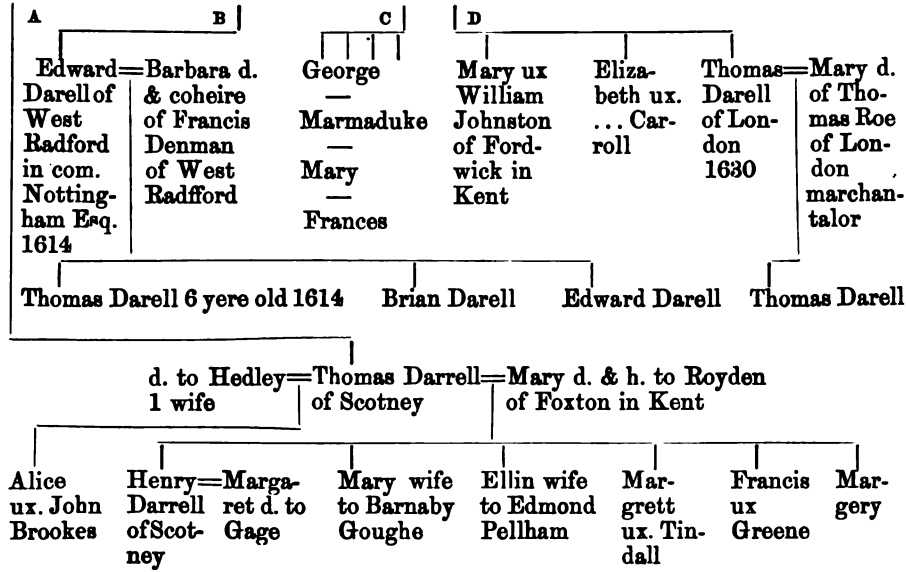

### Eastwood.

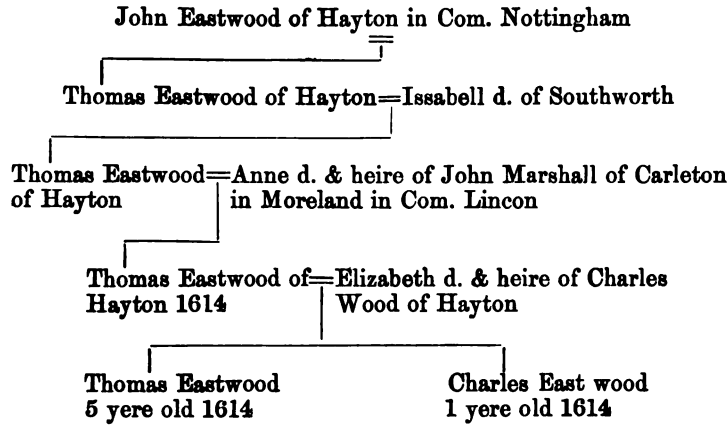

There is no coat given for Eastwood, but the coats of Marshall, Bruse, Hawke, Brown, and Muston (see Marshall) are placed on a shield, the first and two last quarters of which are left blank. (Ed.)

## Clarkson.

ARMS. *Argent, on a bend engrailed sable three annulets of the field.*

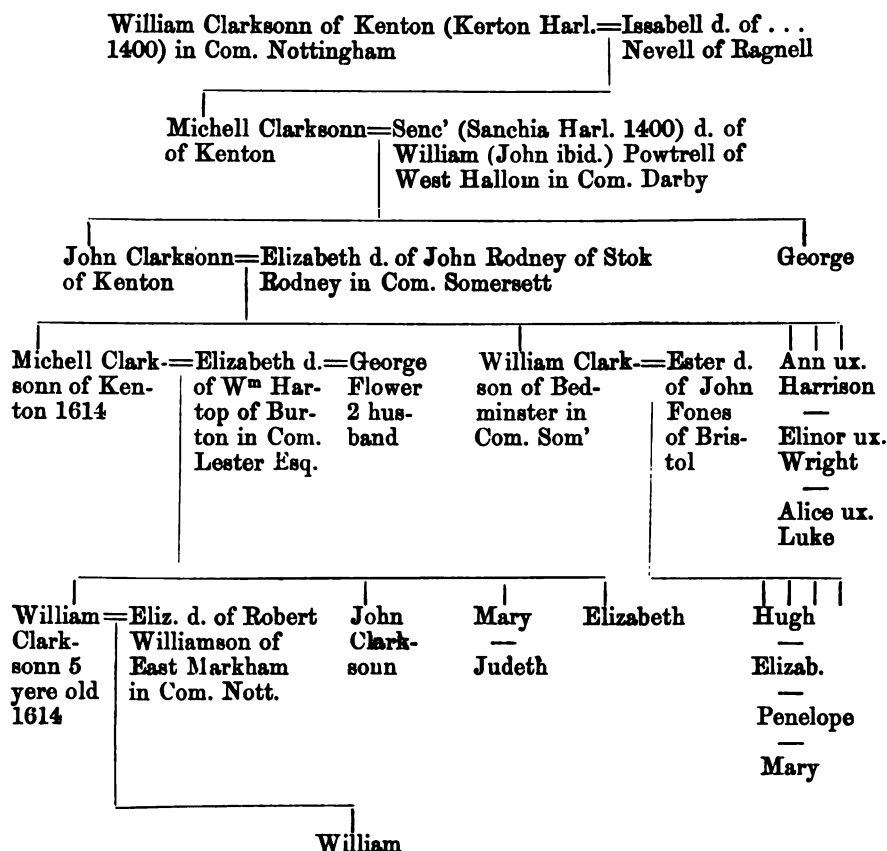

## Eyre.

ARMS. *Quarterly:—1. Argent, on a chevron sable three quatrefoils or. 2. Or, three barnacles sable. 3. Sable, a cross engrailed argent, between four poppy-heads or. 4. Or, three magpies proper.*

CREST. *A leg couped at the thigh quarterly argent and sable, on the heel a spur or.*

Both coat and crest are differenced by a mullet.

William Eyre of Ryton in Com Nottingham = Anne d. & heire of the Lord of  
descended of Eyre of Hope in Com. Darby | Ryton in Com. Nottingham.

Edmond Eyre of Ryton = Margerett d. of Robert Coyney of  
Weston Coyney in Com. Stafford

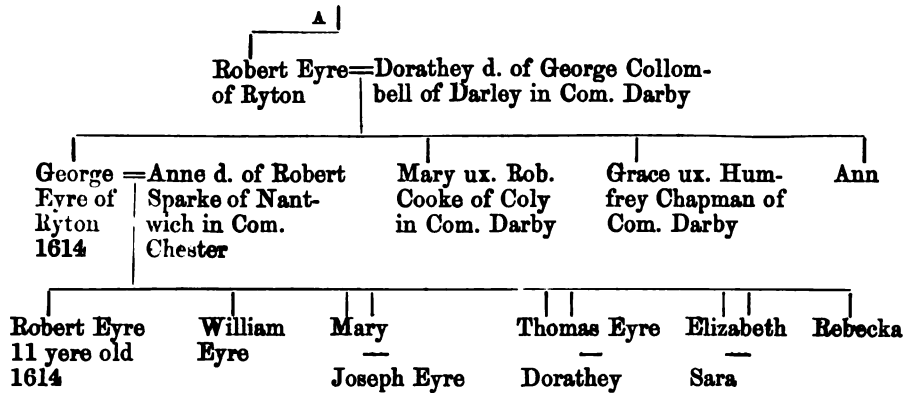

(Harl. 1400.)

The descent of Geruis Eyre of — in Com. Derby, gent., who is descended from a younger branche of the family of the Eyres of Hope in Com. Derby aforesaid, and from the Eyrs of Reyton in the County of Nott., extracted out of the Visitation of Nottinghamsh. and other authentical proofes, by Tho. Thompson Lancaster Herauld, testified and subscribed by Sr Henry Sr George K<sup>t</sup> Norry King of Armes.

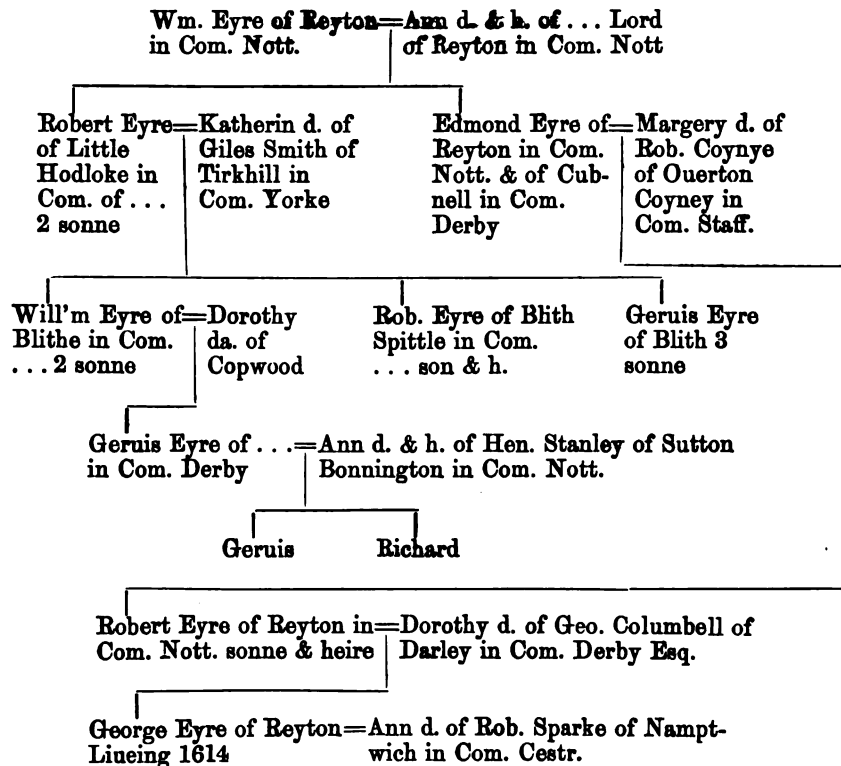

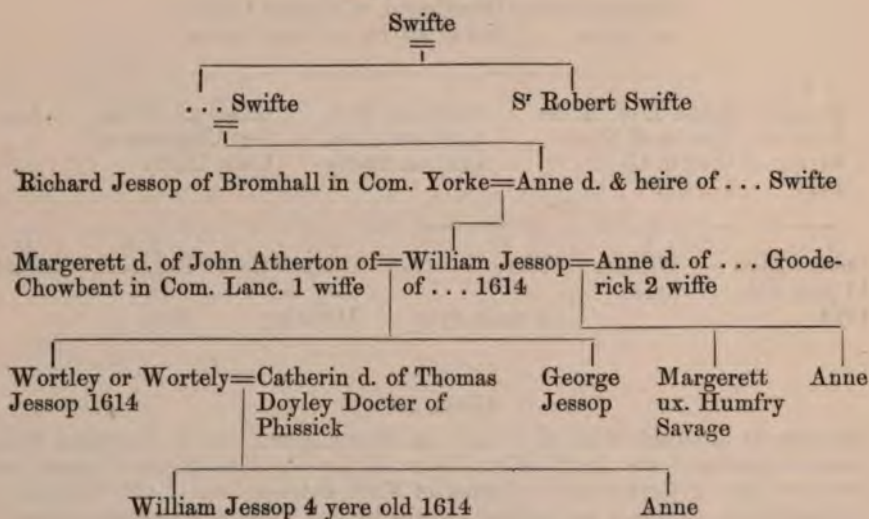
**Jessop.****Bolle or Bolles.**

ARMS. *Quarterly*:—1. *Azure, three boars' heads argent on dishes or, a mullet for difference gold.* BOLLE. 2. *Argent, a chevron gules between three mullets sable, on a chief azure a lion's head erased between two lozenges or.\** BOLLE. 3. *Argent, on a fess vert three crosses moline argent between as many hawks' heads erased sable.†* WATTS. 4. *Gules, a cockatrice or, on a chief argent a label ermine.*

CREST.—*A buck's head sable, collared attired and eared or, erased gules, and charged on the neck with a pallet argent between two plates.*

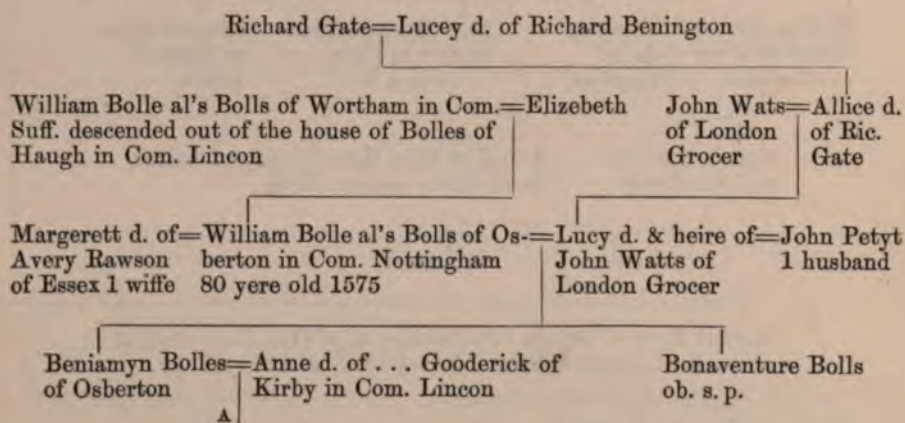

\* "A pattend graunted by William Flower Norrey to William Bolles of Osberton in Com. Nott. the 17th of Queen Elizabeth." The crest is a hawk's head, as in the Arms.

† "A pattend of this coate & crest graunted to Robert Watts of Barkshire 19 H. 7 by Richmond Clarenceux."

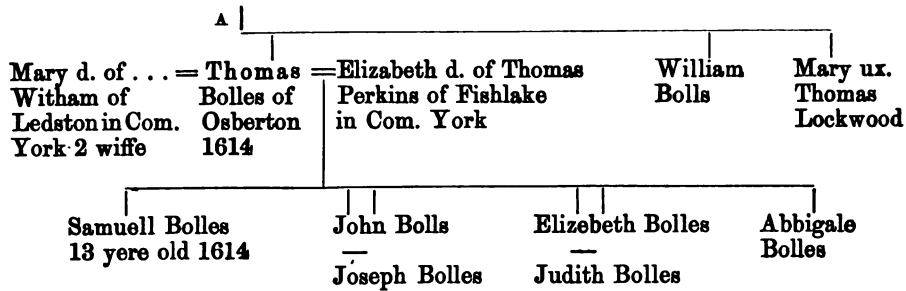

### Cressy.

ARMS. *Argent, a lion rampant double queued sable.*  
 \*CREST. *Out of a coronet or a demi-peacock proper.*

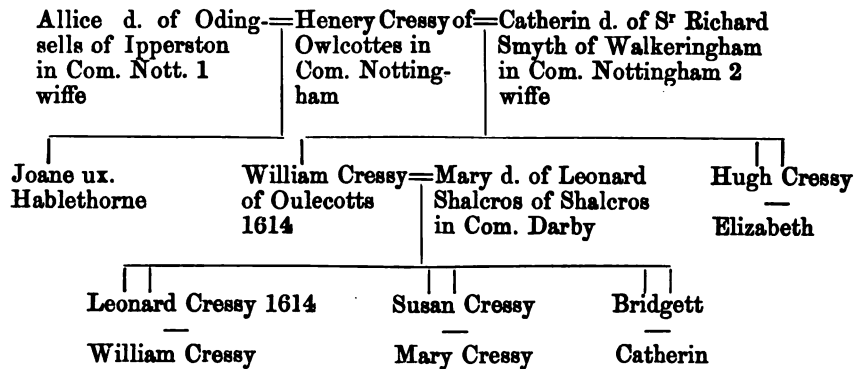

\* The Crest was confirmed by William Flower norry king of Armes to Henery Cressy of Oulecottes in Com. Nott. An° Dom. 1480.

### Lacock.

ARMS.\* *Argent, a dexter gauntlet sable, garnished or.*  
 CREST. *A cock argent, wattled, jelloped, and legged gules, resting his dexter claw on a gauntlet as in the arms.*  
 MOTTO. "VERUS HONOR HONESTAS."

Thomas Lacock was possessed of Lands in Stourton in Com. Nott. and serued K. H. 8 in his warres in Fraunce

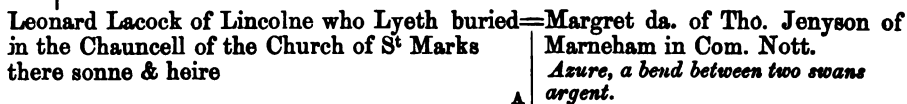

\* Under the hand & seal of Rich. St. george, Norroy, A° 1613, 11 K. James.

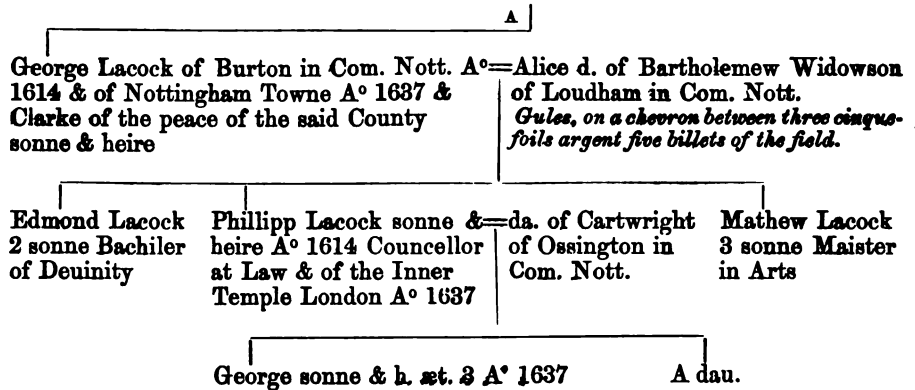

## White.

**ARMS.** *Gules, a chevron engrailed vair between three lions rampant or.*  
**CREST.** *Out of a coronet argent a demi-eagle sable.*

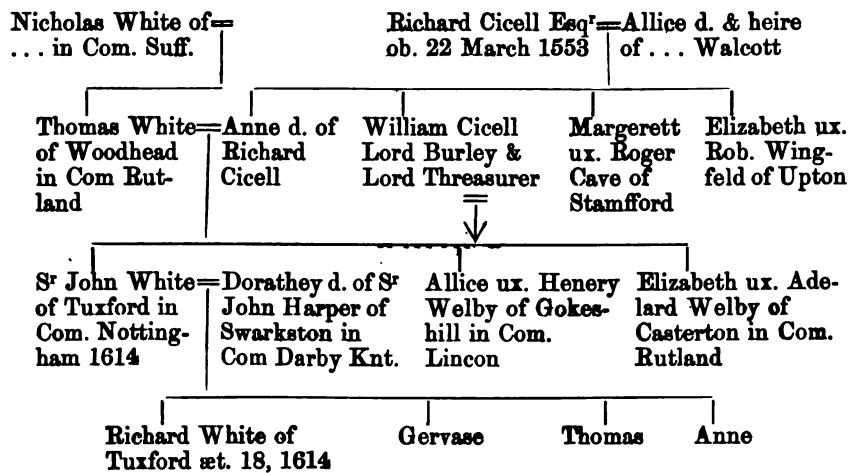

## Williamson.

ARMS. *Or, a chevron gules between three trefoils sable.*  
 CREST. *Out of a mural coronet gules a demy griffin or.*

Given by Will<sup>m</sup> Camden Clarenceux King of Armes 1602.

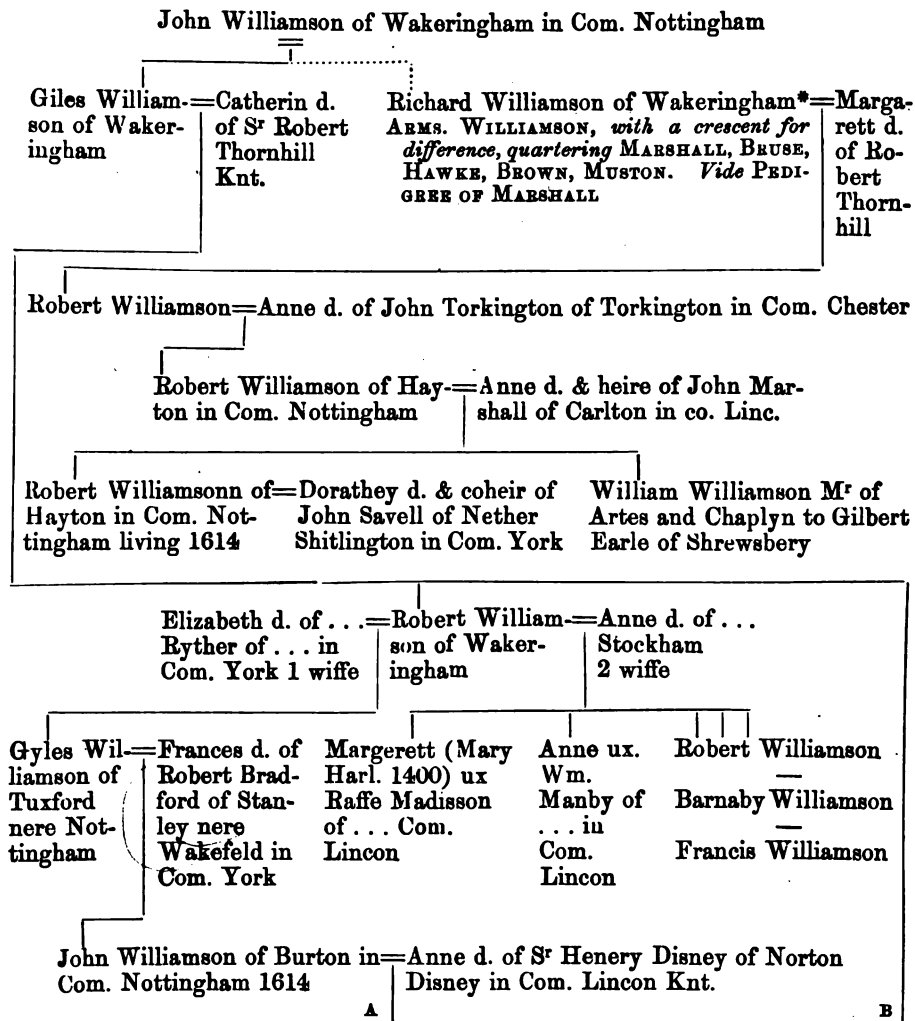

\* This Richard was not brought doune in the pedegree made by Mr. Camden Clarenceux, but by the relation of Robert ; it semeth he was brother to the first Giles mentioned in this pedegree on the other side of the leafe. (Harl. 1400.)

THE VISITATION OF THE COUNTY OF NOTTINGHAM.

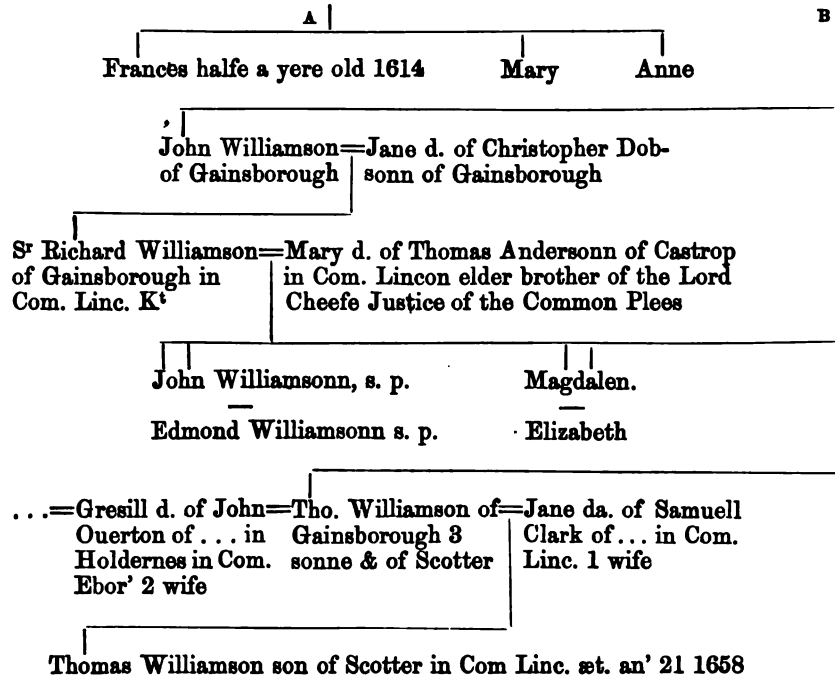



## Burnell.

\***ARMS.** *Per fess indented or and argent a lion rampant sable, on a bordure gules eight bezants.*

**CREST.** *A lion's gamb sable, holding a bunch of violets proper.*

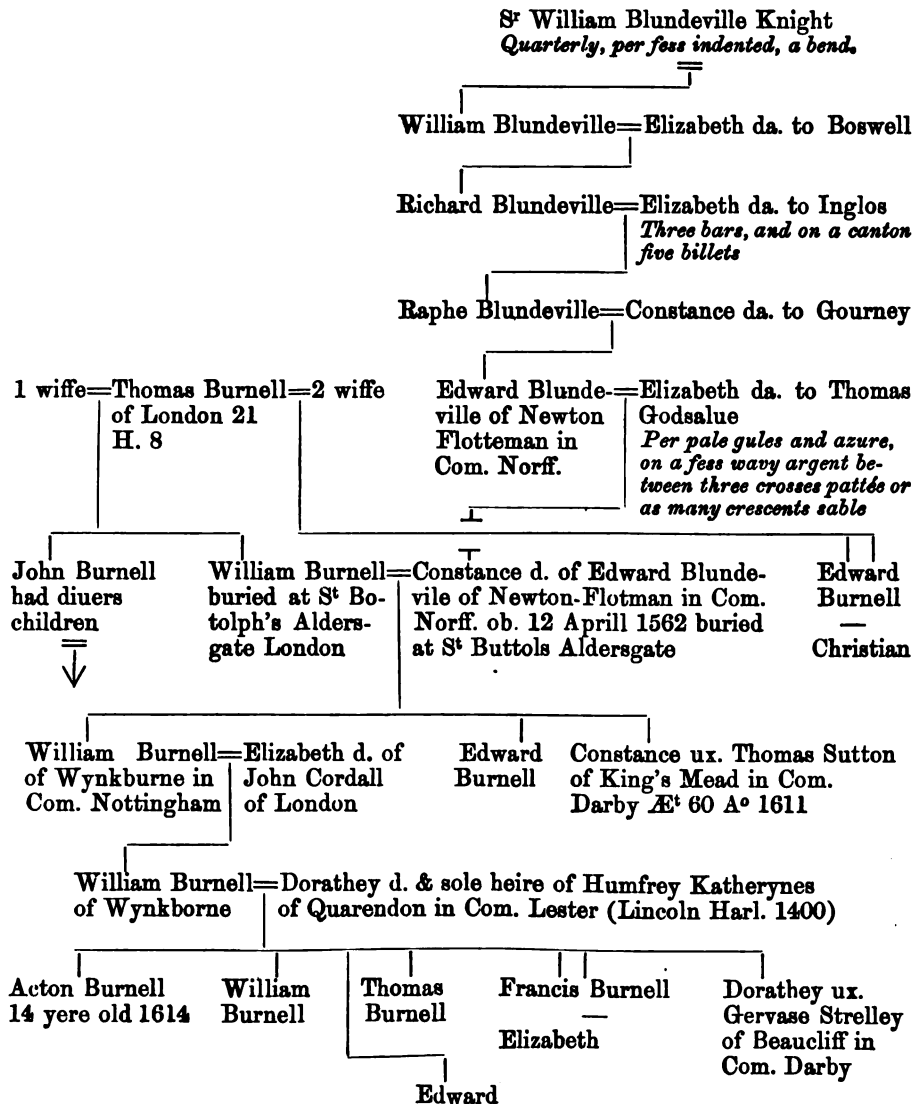

\*1. William Burnell of London & Constance his wiffe, shee died the 12 of April 1562. in St. Botolph's Church without Aldersgate, London.

**BURNELL** *impaling, quarterly per fess indented or and azure, a bend gules.*

2. In Wynkburne Church in Nottinghamshire Burnell Lord thereof in the glas windowes. *Argent, a lion rampant sable, on a bordure gules eight cinquefoils argent.*

3. Willm. Burnell Auditor to K. H. 8 died An° 1571, on a tombe in Wynkburne Church. *Argent, a lion rampant sable, on a bordure gules eight bezants.*

## Sanderson.

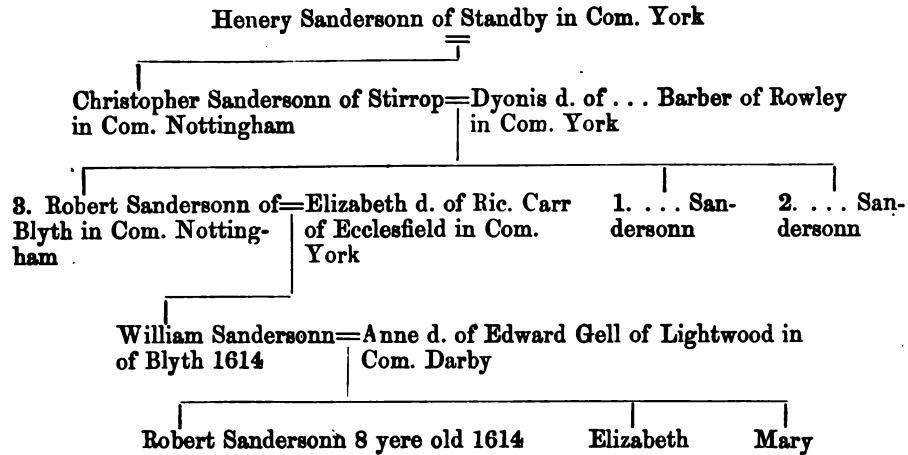

## Leigh.\*

**ARMS.** *Azure, on a fess cotised or, three leopards' faces gules.*

**CREST.** *A demi-Moor vested gules, the sleeves argent, holding in his dexter hand a gem ring and round his neck a collar or, entwined round the temples with a wreath of the second and azure.*

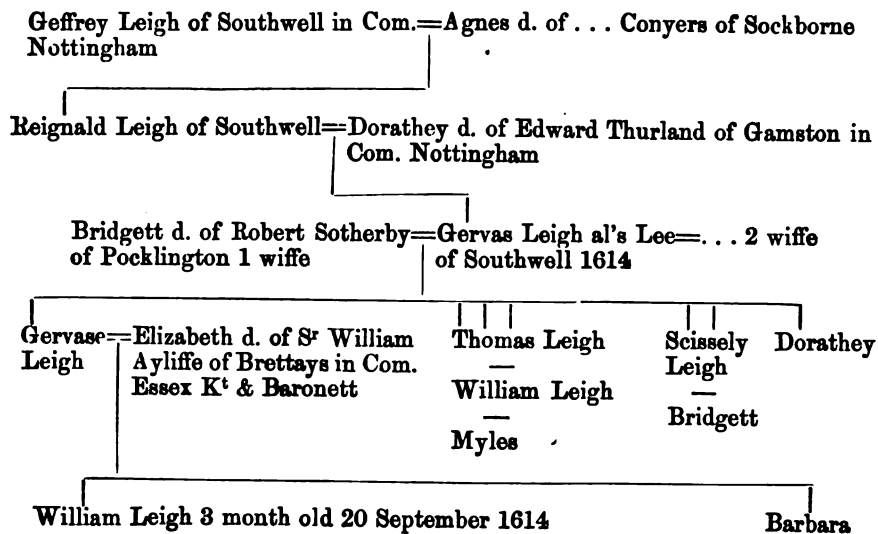

\* This Petigree of Lee you shall find more at large in the uisitation of Kent from whence this Jeffrey Lee is decended.

**Leeke.**

ARMS. *Argent, on a saltire engrailed sable five annulets or, quartering COOPER and SMYTH.*

William Leeke of Hallom in com. Nottingham Esq. ob. 1498

John Leeke of Normanton hall in com. York Esq.

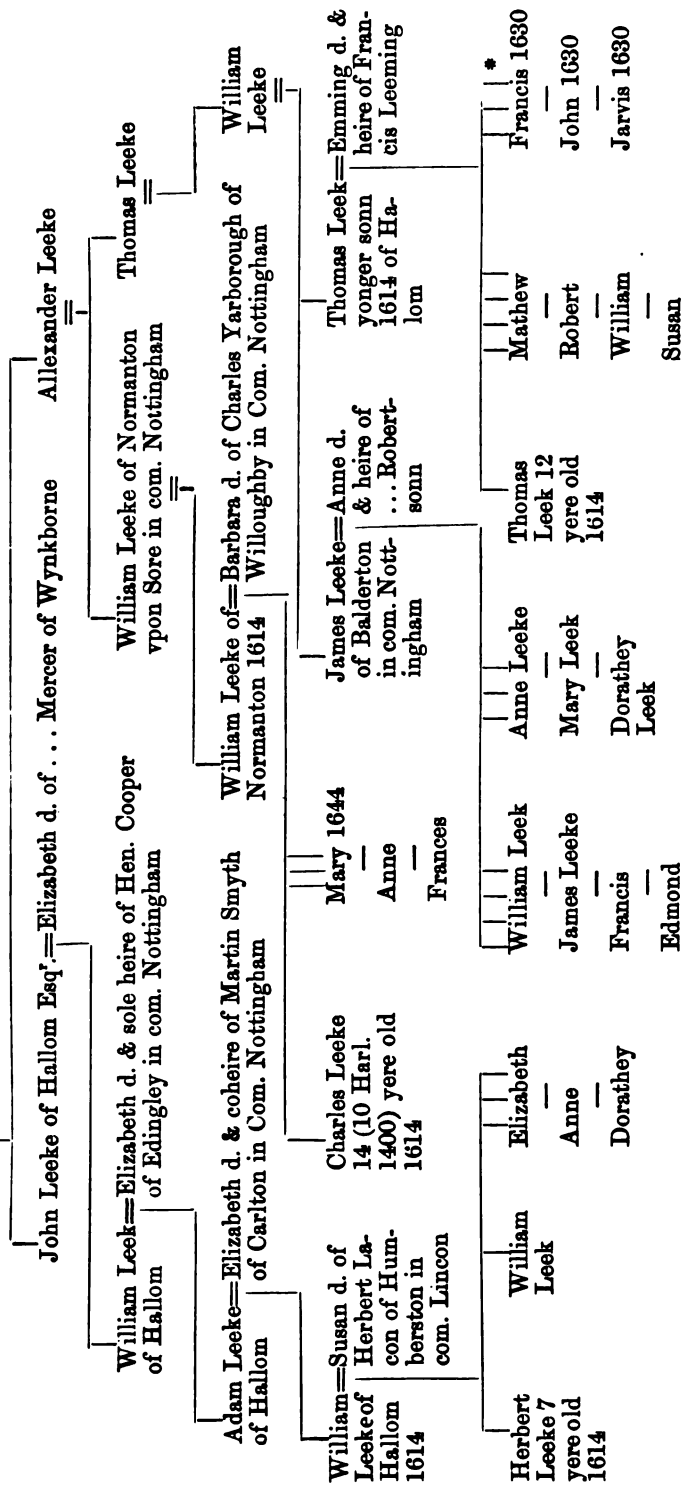

\* These 3 children were borne since the visitation made 1614.

## Willoughby.

**ARMS.** *Argent, two bars gules, charged with three water bougets or.*  
**CREST.** *An owl argent, beaked, legged, and crowned or.*

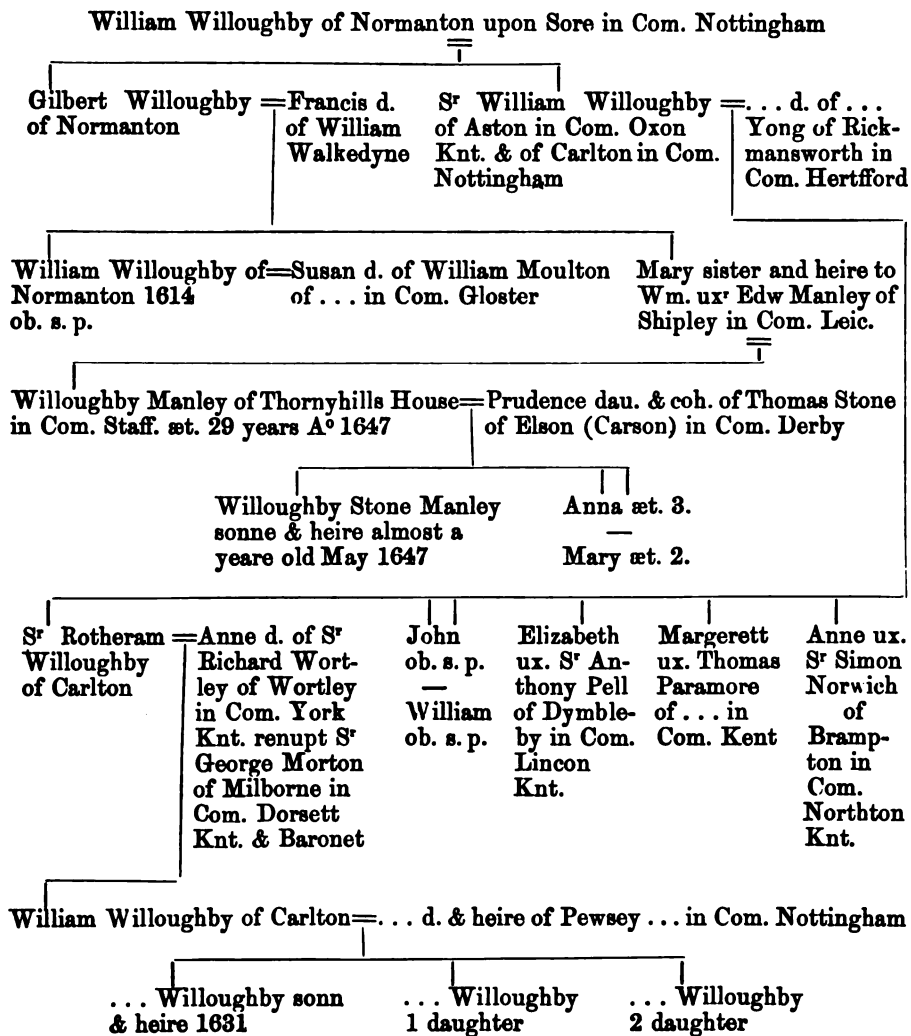

## Holtofte.

ARMS. *Sable, three congers' heads coupéd and erect argent.*

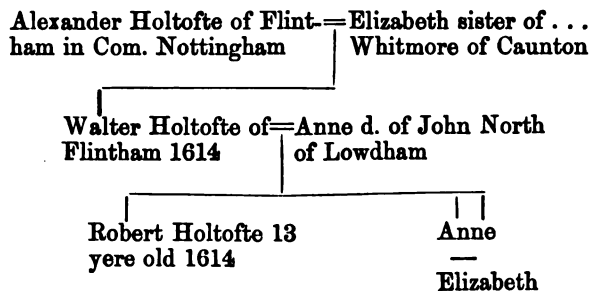

## Cludd.

ARMS. *Quarterly:—1. Argent, a bend double cotised and in chief a martlet (for difference) sable. 2. Ermine, a fret sable. 3. Argent, on a bend sable three martlets of the field. 4. Per fess sable and argent six fleurs-de-lis counter-changed.*

CREST. *A hawk proper, belled or, preying on a grey rabbit vulned in the head gules.*

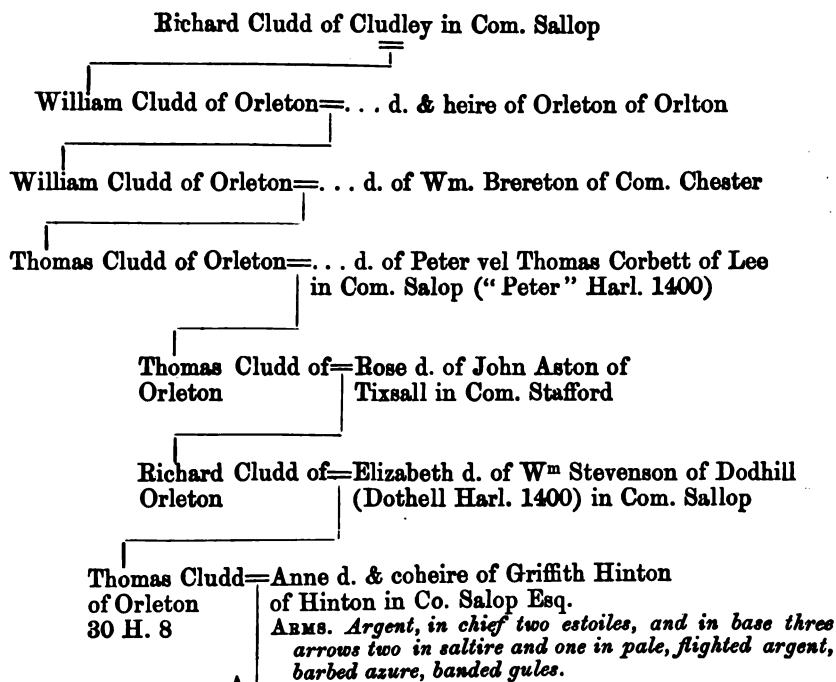

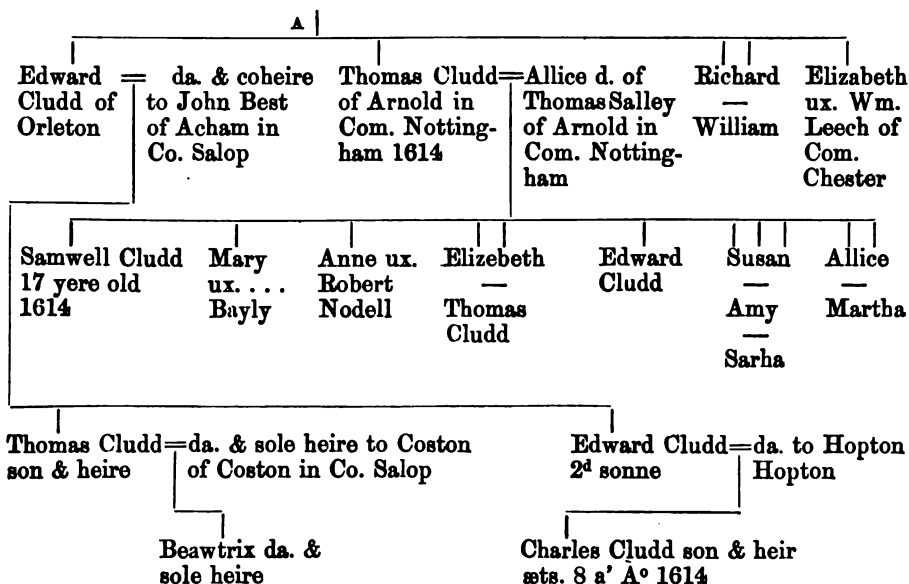

An indenture of marriage betwene Richard Cludd of Orleton in Com. Salope Esq. & Griffeth Hinton of Hinton in the said Countey esq. on the other party for a mariadge to bee had betwene Thomas sonne & heire to the said Richard, and Agnes one of the daughters & coheires of the sayd Griffen Hinton of Hinton Ann° 30 H. 8.

## Ballard.

**ARMS.** *Sable, a griffin segreant ermine beaked and armed or.*  
**CREST.** *A demi-griffin ermine beaked or.*

Phillip Ballard of Greenwich in Com. Kent = Joane d. of Edward Fitzwilliams

William Ballard of Southwell = Anne d. of Lunn of Welley  
in Com. Nottingham in Com. Nottingham

Henry Ballard of Southwell = Elizabeth d. of Thomas Townesend of Testerton  
1614 in Com. Nottingham (Norff. Harl. 1400)

Thomas Ballard  
14 yere old 1614

Catherin  
—  
Anne

William Ballard  
—  
Phillip Ballard

Elizabeth

## Yerburgh.

**ARMS.** *Quarterly*:—1. *Per pale argent and azure, a chevron between three chaplets, all counterchanged.* YERBURGH. 2. *Argent, a rose between six cross crosslets fitchéd gules.* BELINGER. 3. *Sable, a chevron between eight cross crosslets argent.* TEYS. 4. *Argent, a chevron engrailed azure between three birds vert, beaked and legged gules.* ATWELL. 5. *Sable, two lions' gambes erased saltirewise argent.* LEGBORNE. 6. *Gules, a fess humettée argent, in chief three griffins' heads erased or.* ADRYPON. *On a shield of pretence, Argent three whales' heads erased and erect sable.* WHALLEY.

**CREST.** *A hawk belled or, preying upon a mallard vulned in the head proper.*

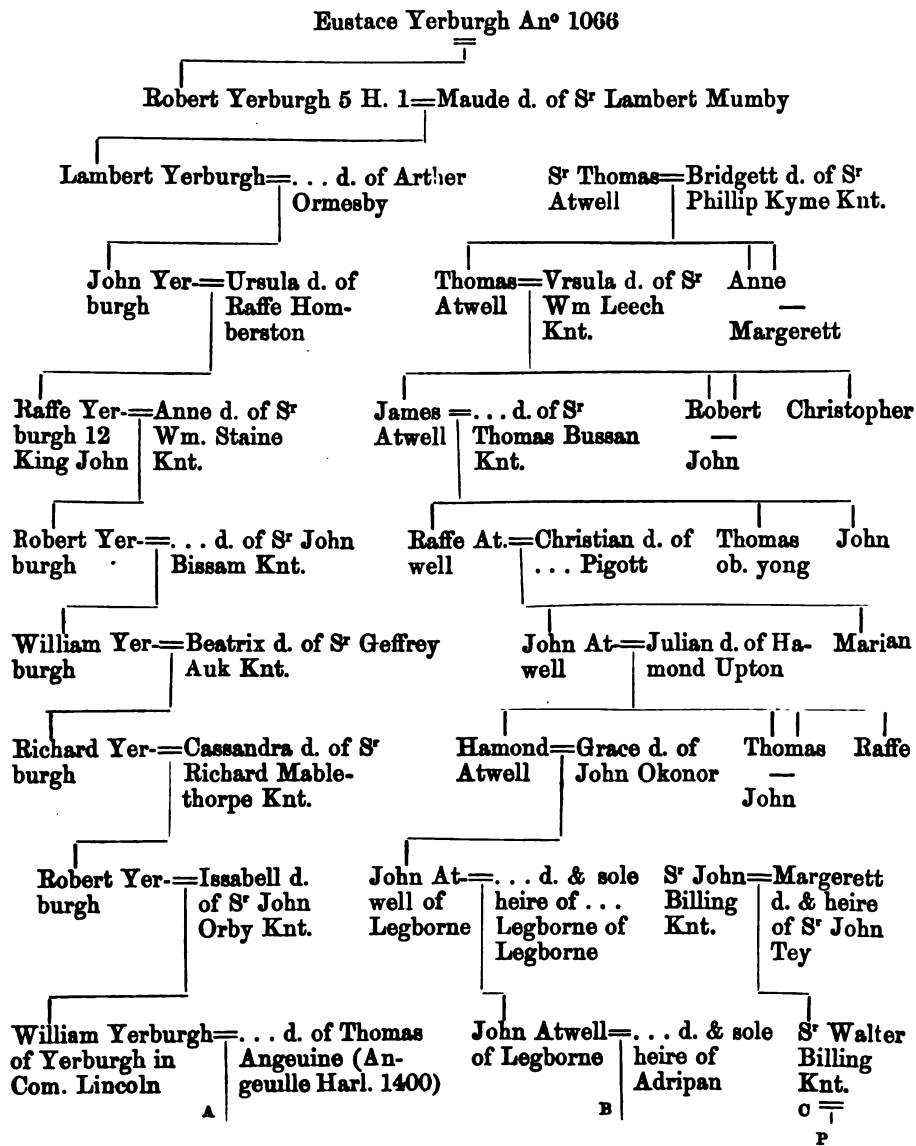

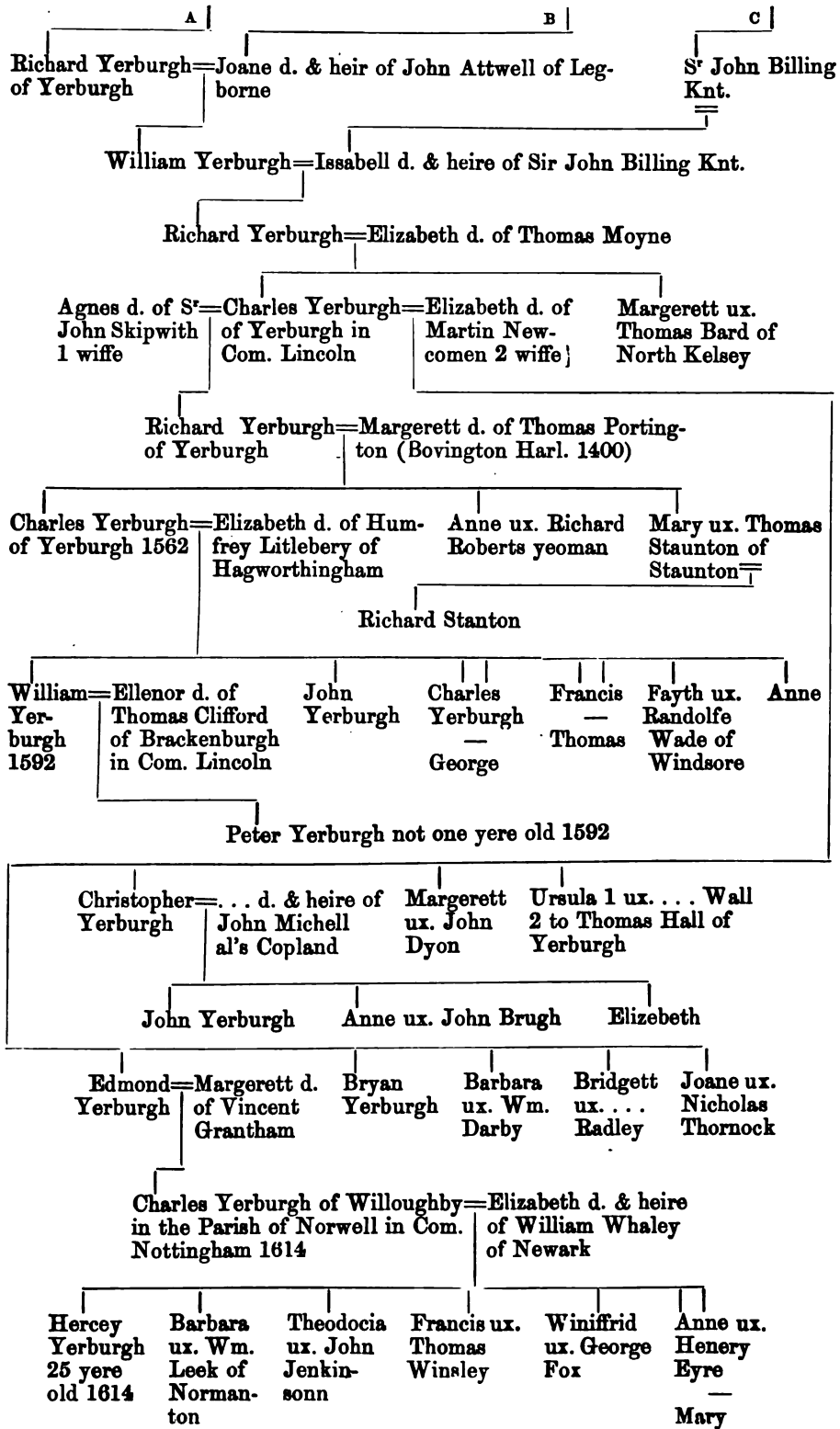



### Golding.

ARMS. *Gules, on a chevron argent between three bezants a trefoil sable.*  
 CREST. *A griffin's head erased and collared (Harl. 1400).*

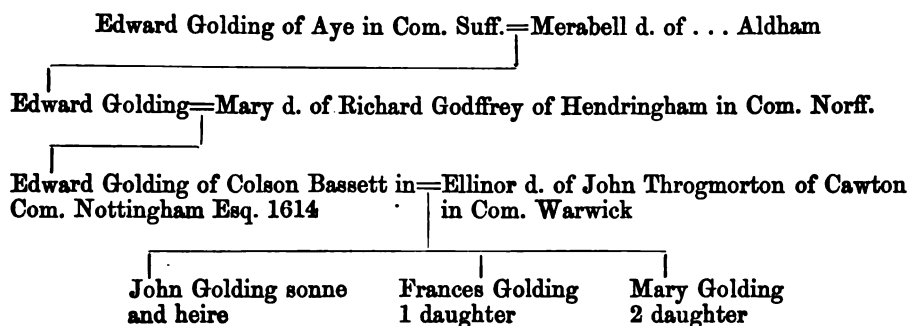

### Pendock.

ARMS. *Quarterly:—1 and 4. Gules, two bars gemelles argent, on a chief of the last 5 trefoils vert. PENDOCK. 2 and 3. Argent, three bars embattled gules. BARREY.*  
 CREST. *A pelican or issuant out of a tower, and vulning herself gules.*

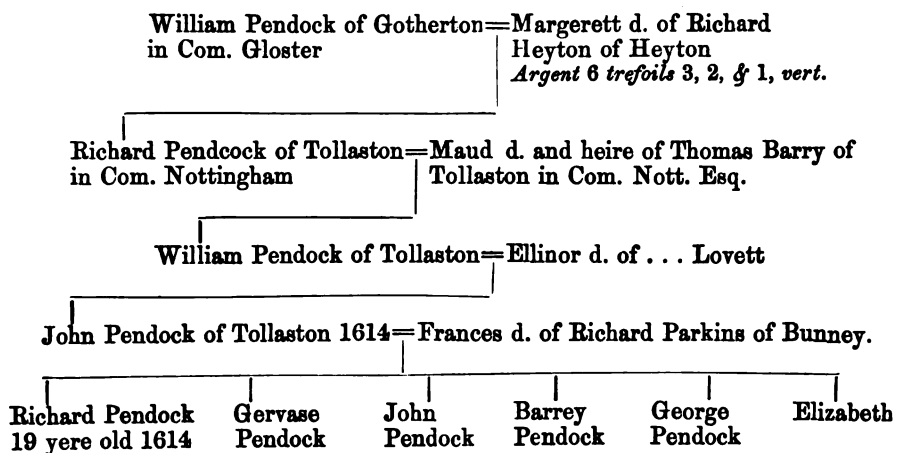

### Reynes.

ARMS.\* *Chequé or and gules, on a bend vert a leopard's face between two annulets or, a canton ermine.*

CREST. *An arm issuant out of clouds proper, holding in the hand three roses or, stalked and leaved vert. (The roses proper in Harl. 1400.)*

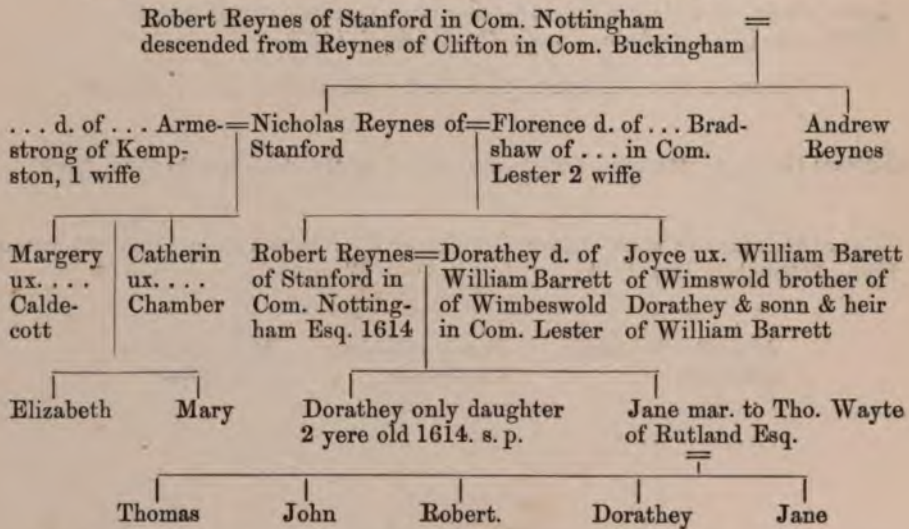

\* These Armes and Crest was graunted to Robert Reynes of Stanford in Com. Nottingham principl Goldsmith to Q. Mary 1558 per William Harvey Clarenceux.

### Widmerpoole.

ARMS. *Azure, three estoiles pierced argent.*

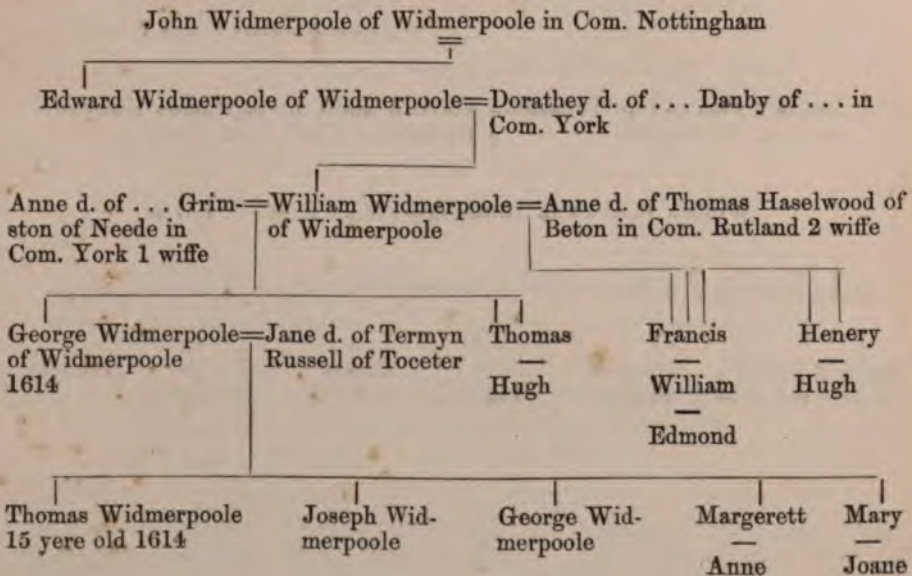

# Cartwright.

**ARMS.** Quarterly:—1. Ermine, a fess sable\* between three fire-balls, a crescent for difference. 2. Azure, a cross moline or. 3. Gules, a lion rampant argent crowned or, a bordure engrailed of the last. 4. Argent, six lionsels rampant, gules 3, 2, & 1. 5. Or, three leopards' faces sable. 6. Argent, a hart lodged proper. 7. Argent, on a fess gules between three birds... beaked, legged, and collared of the last a mullet or. 8. Azure, a lion rampant guardant within an orle of fleurs-de-lys argent. 9. Vert, a lion rampant argent. 10. Argent, a cross and in the first quarter a fleur-de-lys sable. 11. Ermine, three bars humettés gules a crescent for difference. 12. Gules, two lions passant guardant argent collared azure. 13. Or, a bend fusilly sable. 14. Vert, two chevrons in saltire ermine. 15. Per pale indented argent and gules, a crescent for difference. 16. Argent, a fess gules between two greyhounds courant sable. 17. Sable, a chevron between three bears gules. 18. Argent, a chevron between three boars gules.

**CREST.** A wolf's head erased or pierced through the neck with a sword blade broken off at the hilt proper.  
(There are 18 quarters in the shield left blank.)

Hugh Cartwright=Maud d. of ... Coe.

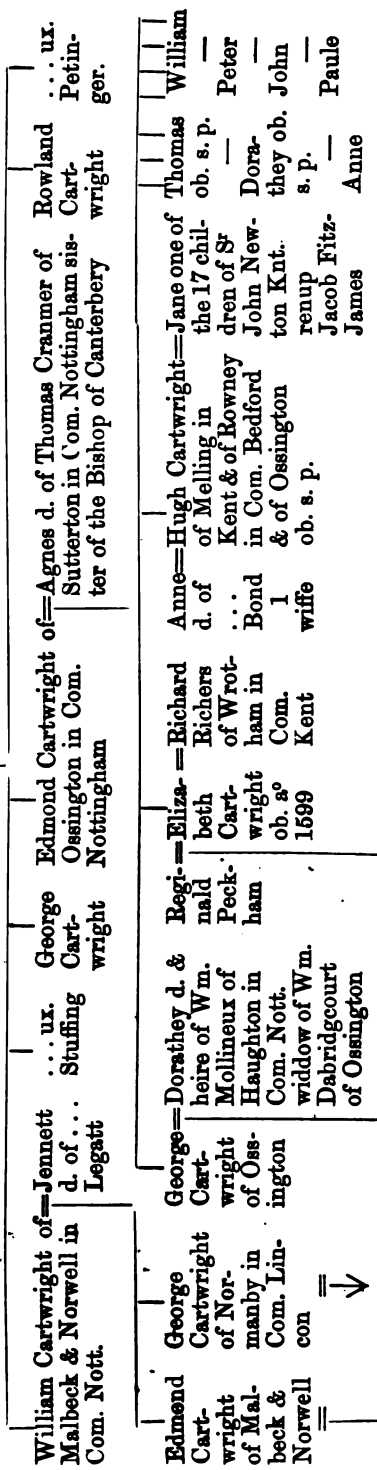

† William Cartwright of Malbeck and Norwell

William Cartwright of Ossington heire to his vnkle Hugh

Grace d. and heire of Thomas Dabridgecourt of Longdon Hall in Com. Warwick (Co. Nott. Harl 1400)

Edmond George Robert Elizabeth ux. William Cartwright of Norwell Elizabeth in Com. Nottingham.

\* The fees borne gules by the first Hugh Cartwright. † Omitted in Harl. 1400.

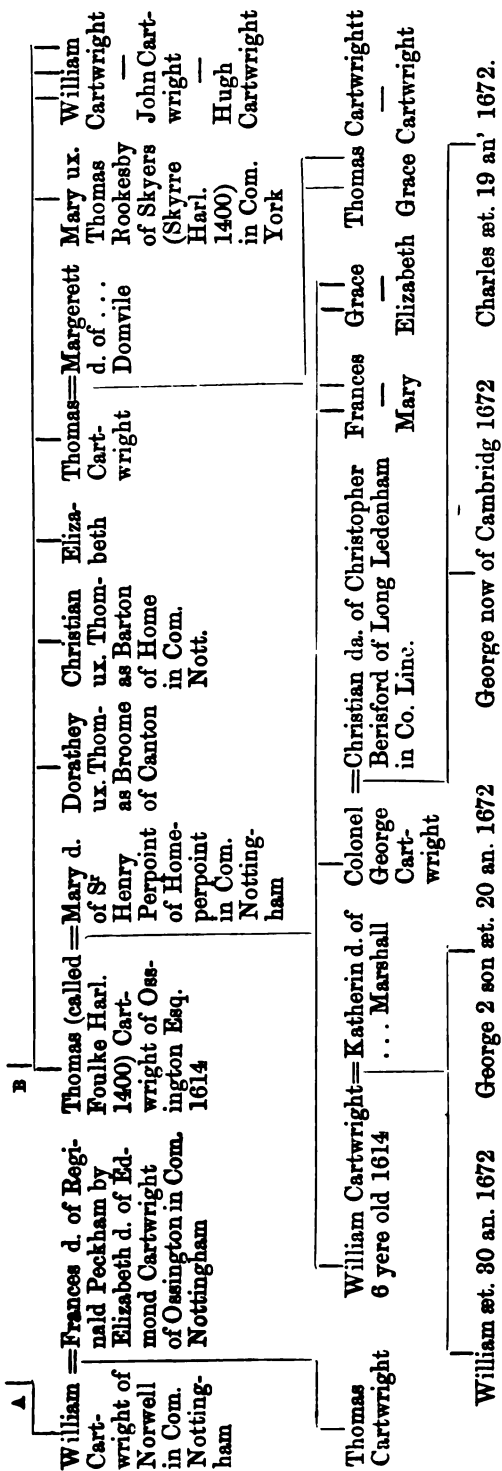

**Roos.**

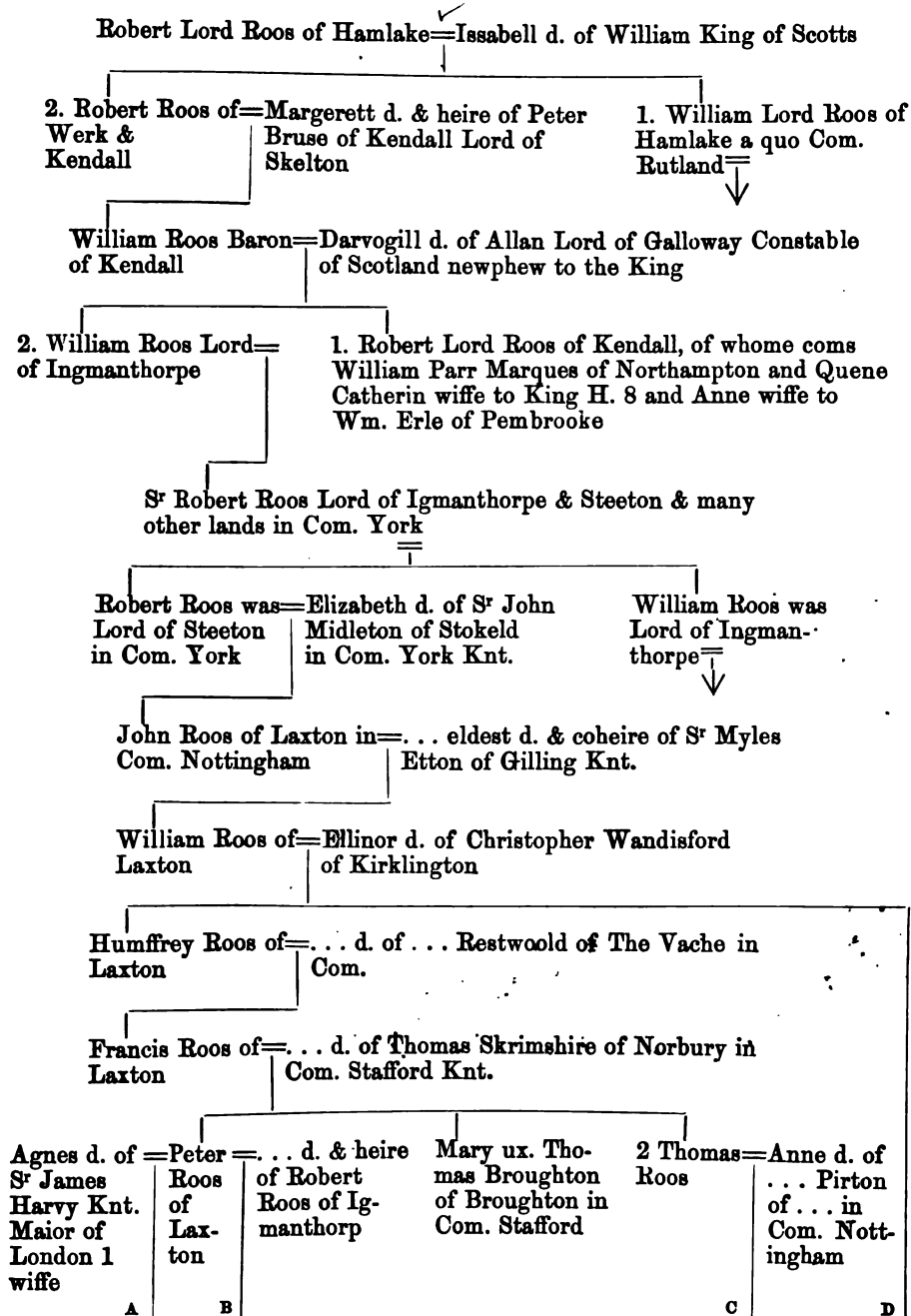

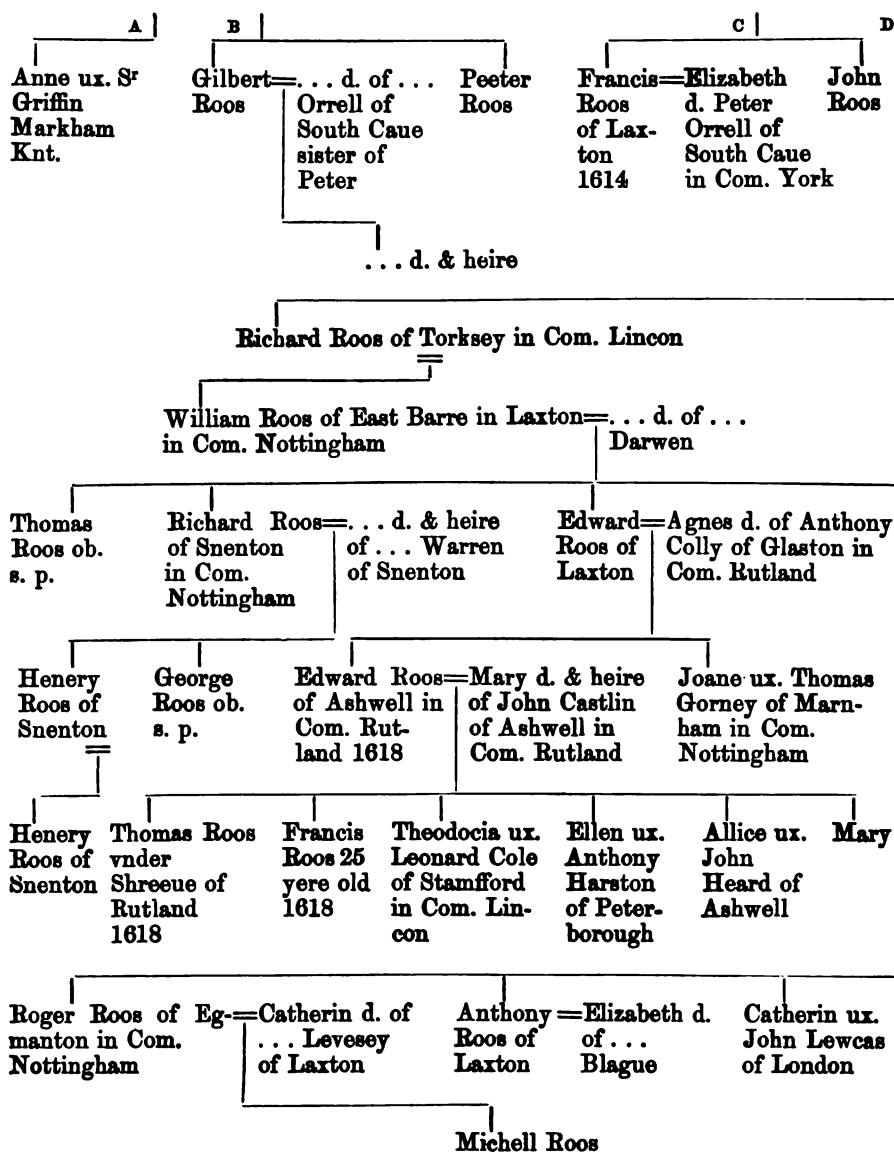

**Fenton.**

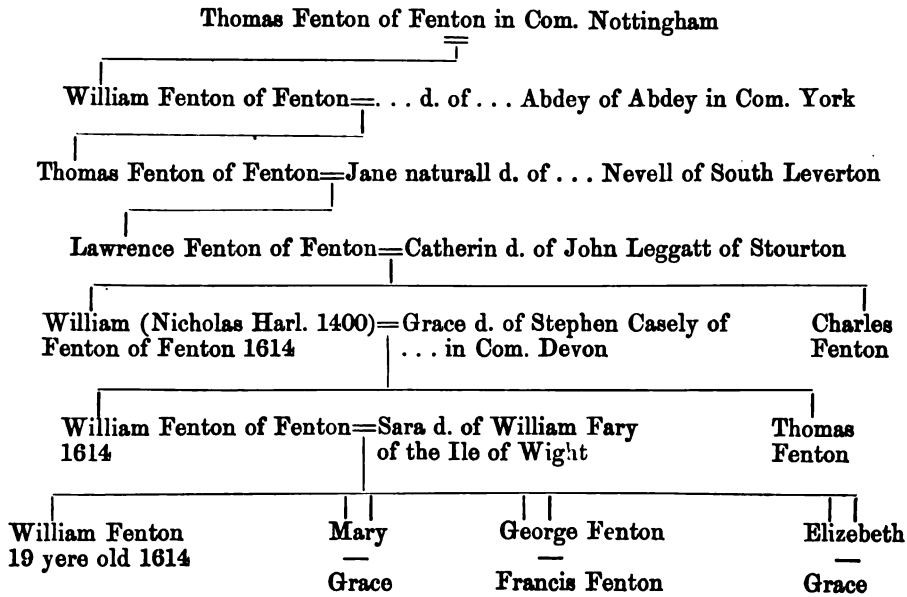

**Blacknall.**

ARMS. *Per bend or and azure, an eagle displayed, counterchanged.*

This Coatte is borne by the name of Blackenall, but not allowed to this man.

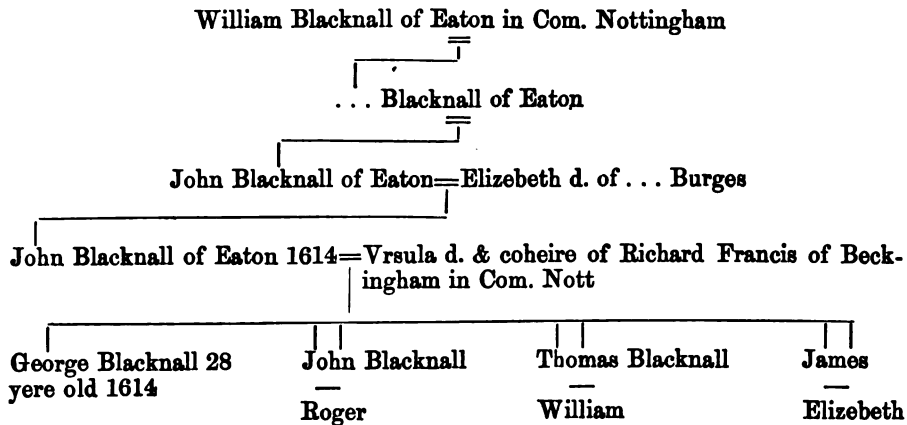

## Southworth.

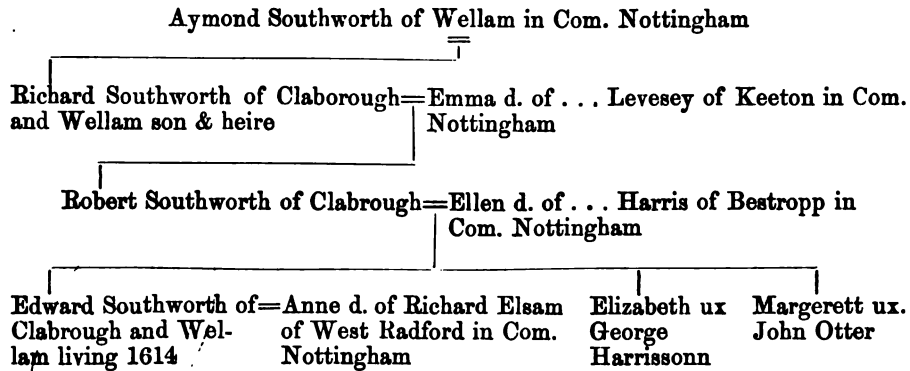

## Brodhent.

**ARMS.** *Per pale ermine and azure, a fess wavy gules.*  
**CREST.** *A broken arrow-head, the staff or, pheon argent, embued gules.*  
 This coate and crest was granted to John Brodbent by William Camden Clarenceux An<sup>o</sup> 1601 in the 43 yeare of Queene Elizabeth.

John Brodbent of Stapleford in Com. Nottingham 1614=

## Wymondeswold.

**ARMS.** *Argent, a chevron between three martlets sable.*  
**WYMONDESWOLD** *impaling argent on a saltire engrailed sable, five annulets or.*

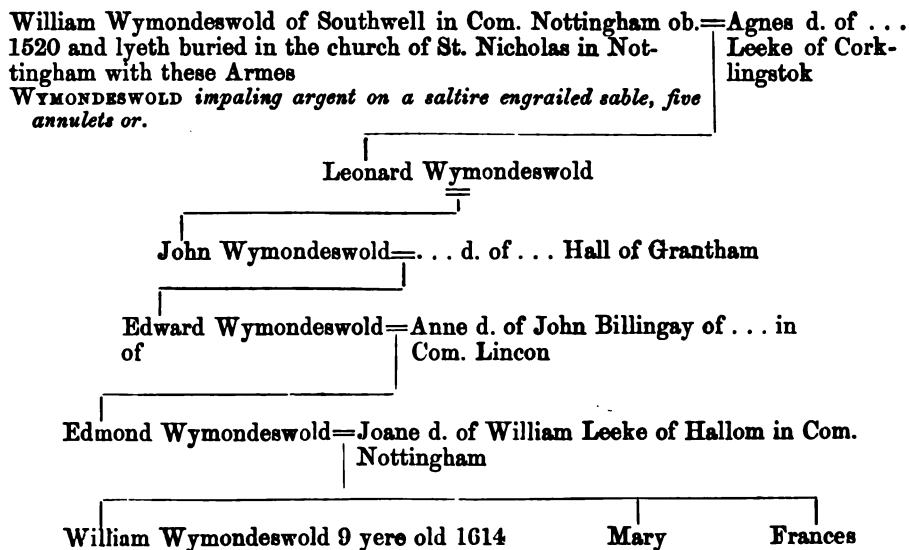



### Pigott.

ARMS. *Sable, three pickaxes argent, a mullet for difference or.*

Quere the armes, for I think this coate doth not belong to him.

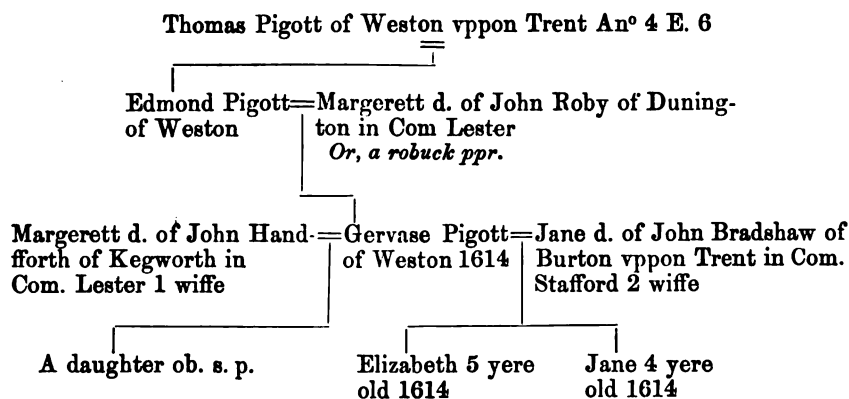

(FROM HARL. 1400.)

ARMS. *Sable, three pickaxes argent, the handles or.*

CREST. *A greyhound couchant sable, collared argent, the collar garnished or.*

The armes, creast, and descent of Geruas Pigot of Thrumpton in Com. Nott. (sonne of Edmond Pigot of Weston vpon Trent, and Margret his wife d. of John Roby of Duntington in Com. Leicester sonne of Tho. Pigot of Weston aforesaid that liued A<sup>o</sup> 4 E. 6) mar' to his first wife margret d. of John Hanforth of Kegworth in the said county of Leicester by whom he had issue onely 2 daughters who dyed issueless, his 2<sup>d</sup> wifes name was Joane da. of John Bradshawe of Burton in the county of Staff. by who he had issue 2 daughters (viz.) Elizabeth Pigot aged 5 yeares and Joane Pigott aged 4 yers A<sup>o</sup> 1614. In w<sup>ch</sup> yeare the Visitacon booke of Entries of the Gentry of Nottinghamsheire was made, and therein folio 146 the said armes, creast, and descent remaine registred by me.

Ri. S<sup>t</sup> George Norroy King of Armes.

### Hutchinson.

ARMS. *Per pale gules and azure, semé of cross crosslets or, a lion rampant guardant argent.*

CREST. *A cockatrice azure, legged and combed or.*

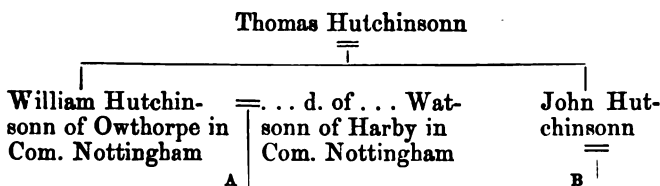

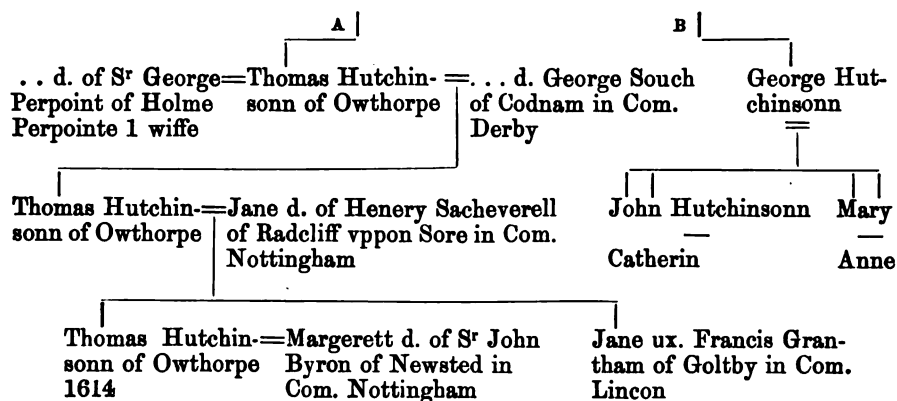

## Whalley.

*ARMS. Argent, three whales' heads erased sable.*

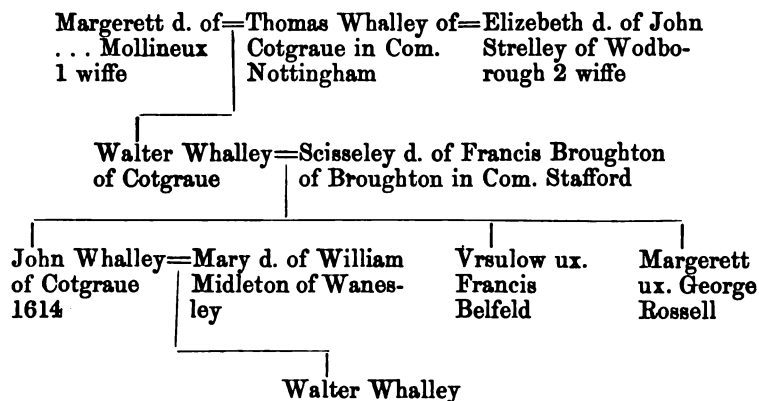

Whalley.

ARMS.\* Quarterly:—1. *Argent, three whales' heads erased and haurient sable.* WHALLEY. 2. *Gules, a lion rampant argent.* MOWBRAY. 3. *Argent, a cross raguly couped gules.* 4. *Argent, on a saltire engrailed sable nine annulets or, a bordure of the second semée of cross crosslets fitché of the first.* LEAKE. 5. *Gules, a fess fusilly or, a bordure of the last semée of cross crosslets sable.* 6. *Argent, a fess and in chief a chevron gules.* KIRTON. 7. *Gules, a chevron vair between three mullets or.* 8. *Ermine, on a chevron sable three cinquefoils or.* HATFIELD. 9. *Or, a saltire gules between four eaglets azure.* MALLETT. 10. *Azure, a bend argent, a bordure engrailed of the last.* WARDE. 11. *Gules, a chevron between three eaglets argent.*† FRANCIS. 12. *Gules, a fess ermine between three (all's 6) round buckles or.* SELIOKE.  
 CREST.—*A whale's head erased haurient.*

John Ward Lord of Willoughby nere Newark vpon Trent

John Ward=Issabell d. & heire of Sr John Selioke Knt.

Richard Whalley of Darleston=Elizabeth d. & heire of Thomas Leek of Kirton Hall in Com. Nottingham Richard=Issabell d. & heire Mallett

Thomas Whalley of Kirton in Com. Nott. ob. 18 E. 4

Robert Mallett=Jane d. of Rob. Francis of Fornwarke (ffenwarke Harl. 1400) in Com. Derby

Thomas Whalley of Kirton

Thomas Hatfeld of Willoughby=Anne d. & sole heire of Robert Mallett

Richard Whalley of Kirton in Com.=Lora d. of . . . Brook-Nottingham ob. 25 Q. Elizabeth man in Com. Essex

Henary Hatfeld=Anne 3 d. of Hum=Robert Markham of Willoughby fry Hercye 2 husband

\* Another shield is tricked with this note,—“thus quartered in the visitation in the office.” It has only 8 quarters:—1. WHALLEY. 2. LEEKE. 3. MOWBRAY. 4. As 5 above, without the cross crosslets on the bordure. 5. Ermine & chief azure. [FRIZARCHES.] 6. As 3 above. 7. As 7 above. 8. KIRTON. † The colours are vice versa in Harl. 1400.

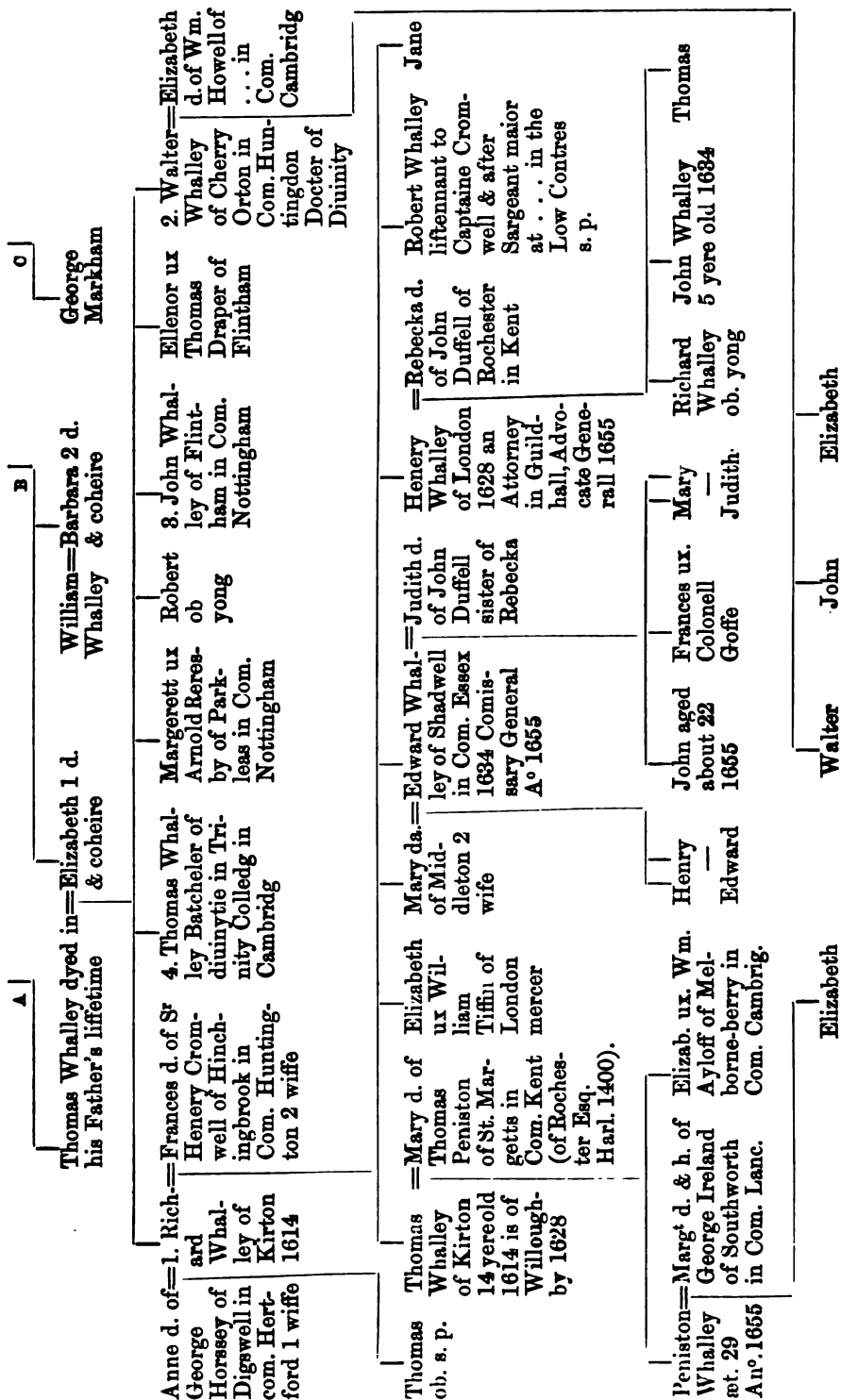

## Lyndley.

ARMS. *Argent, on a chief sable three griffins' heads erased of the field.*  
 CREST. *A griffin's head argent, gorged with a bar gemel sable.*

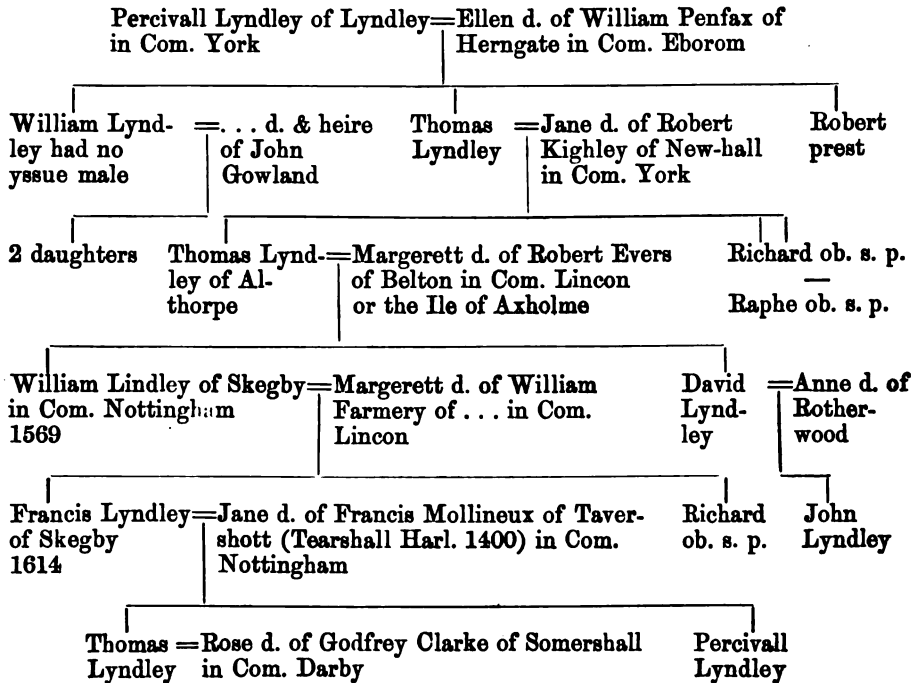

## Rossell.

ARMS. *Quarterly:—1 and 4. Argent, on a bend sable three roses or. 2. Argent, on a chevron azure between three pelicans sable, as many cinquefoils or. 3. Argent, a fess fusilly gules, each fusil charged with an escallop or.*

The 1 Coate being the Roses in bend is borne by the name Hawslyn and but vsurped by Rossell.

Simon de Rossell of Cotgraue in Com. Nottingham

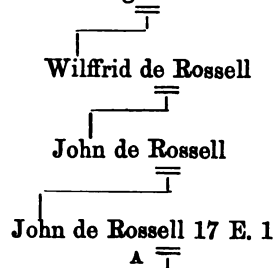

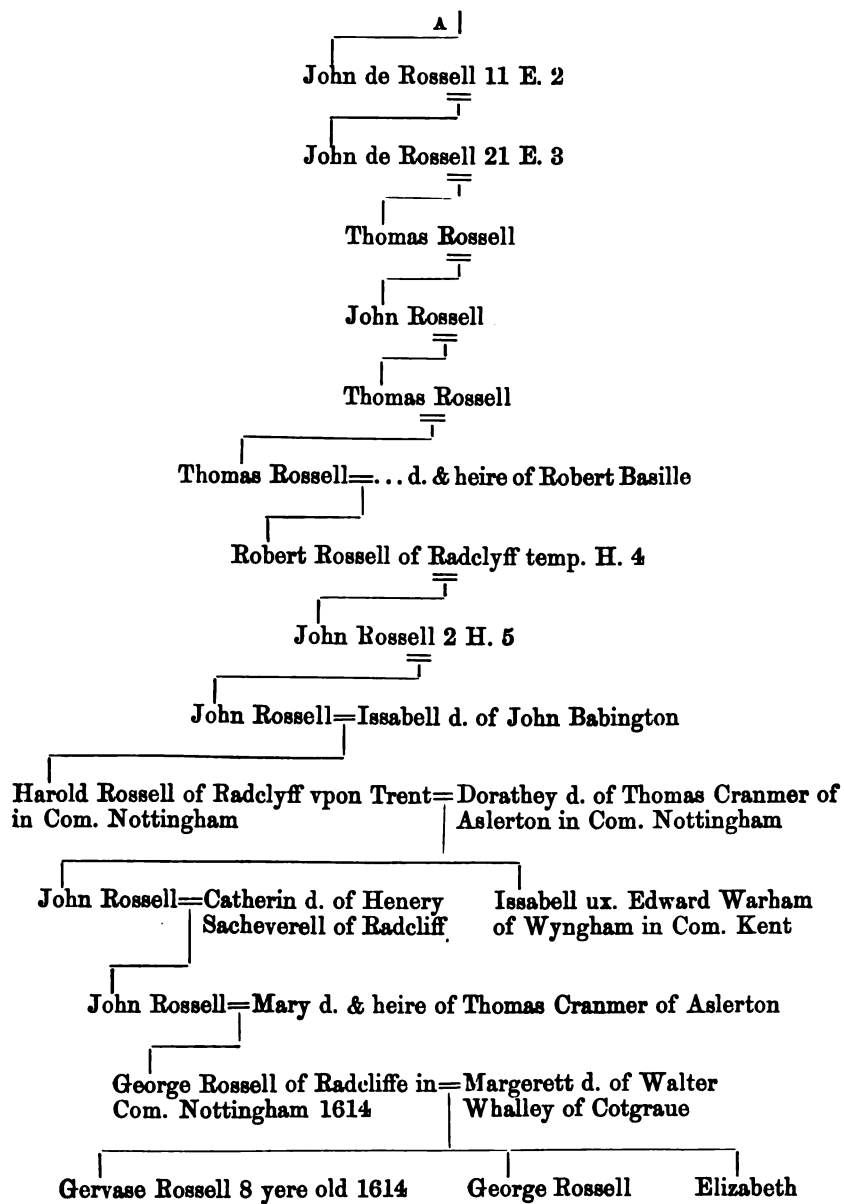

# Bingham.

(Harl. 1400.)

ARMS. *Or, on a fess gules three water bougets argent.*

Johannes Bingham de in . . . Co. Nott. A° 23 H. 6 = Eliz. fl. et heres Norm' Charnells de Muston in Com. Leic. p' Margaret

Margeria fl. et heres Tho. = Ricardus Bingham Justiciar' de Banco R° t' p' = Margeret fl. et coh. Baldwini Freuill  
 Rempston Milit' Garterii E. 4 fuit de Watnow-Chaworth in Co. Nott. Milit' post nepi' (sic) Hugh Willughby

Joh' Bingham

Ric. Bingham fl. & h. Joh'is Bingham de Watnow in Co. Nottingham = Anna soror et her. Nich. Strelly Milit' de Linby in Com. Nott.

Anna fl. et coh. uxor Rad'o Purefy qui obiit 4 Ed. 6

Margeria coh' ux. Rad'i Rollston de Rolleston in Co. Staff.

# Flower.

ARMS. *Ermine, a cinquefoil ermines impaling Quarterly—1 and 6. Quarterly:—Gules and vert, a lion rampant argent. HUNINGS. 2. Or, three owls sable. OWLE. 3. Argent, on a chevron sable a fleur-de-lis or. CAVER. 4. Gules, on a fess between four fleurs-de-lis or two of the field, in chief a trefoil for difference argent. DAVILL. 5. Sable, a bend cotised flosy or charged with an ermine spot. KELK. CREST. A lion's head erased argent, charged with a mullet for difference gules.*

Thomas Flower

... 1 wife = John Flower = Ellinor d. of . . . Meering = Lancelott Rowleston of of . . . Watnoll in Com. 2 wife	Henery Flower of Langer in = Cassandra d. of Com Nottingham bayley to the Lord Scrope. . . . in Com. Stafford
A	C

\* In Harl. 1400 this is Or, on a fess between six fleurs-de-lis gules three of the field. In No. 5 the bend is argent.

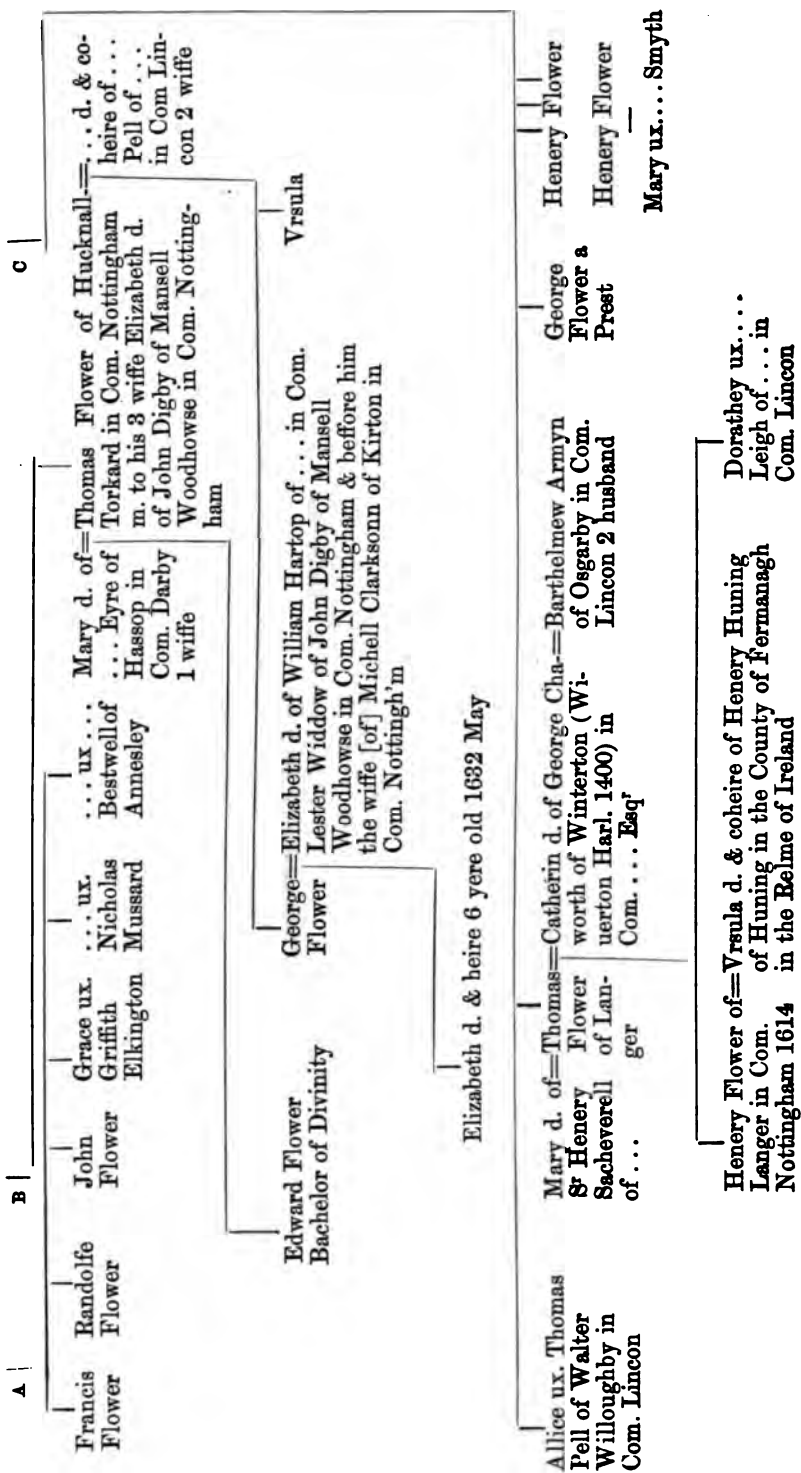



# Chaworth.

ARMS. Quarterly:—1. Barry of ten argent and gules, an orle of marlets sable. CHAWORTH. 2. Azure, two chevrons or. ALFRETON. 3. Argent, an escutcheon within an orle of ten cinquefoils sable. CALFOTTE. 4. Gules, a fess dancettée between ten billets or. BRETT. 5. Azure, a hedgehog or. HERRIZ. 6. Or, three piles conjoined in base gules, a canton ermine. BASSETT. 7. Azure, a cross argent. AYLESBURY. 8. Vair, three bars gules. KAYNES. 9. Argent, three pallets gules, a bordure azure bezantée. BASSETT OF WILDON. 10. Barry of six argent and azure, on a bend gules three mullets or. PABENHAM. 11. Gules, a fess dancettée between six cross crosslets or. ENGAINE. 12. Paley of six argent and azure, a bend gules. ANNESLEY.

CREST. A tower argent, on the battlements a plume of five feathers argent.

Radulphus de Alfreton (Beignold Knt Harl. 1400)

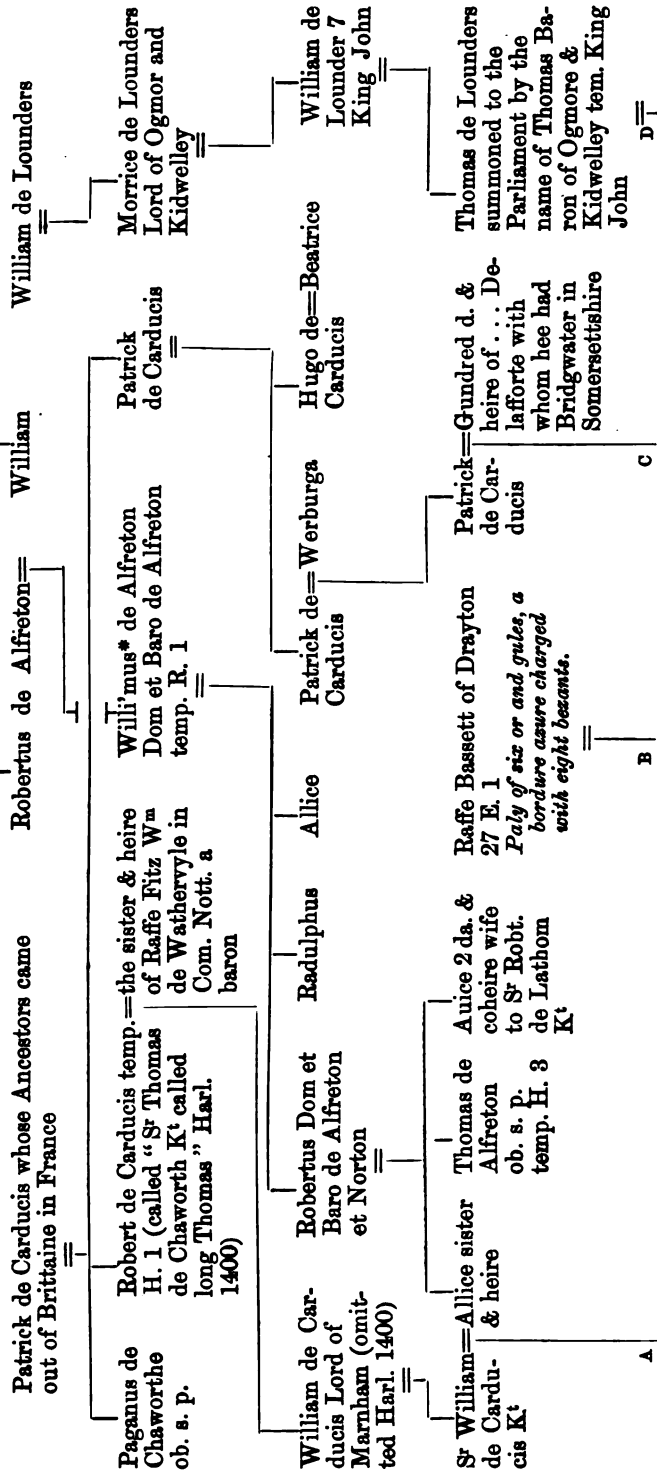

\* Called Robert, and made son of William in Harl. 1400.

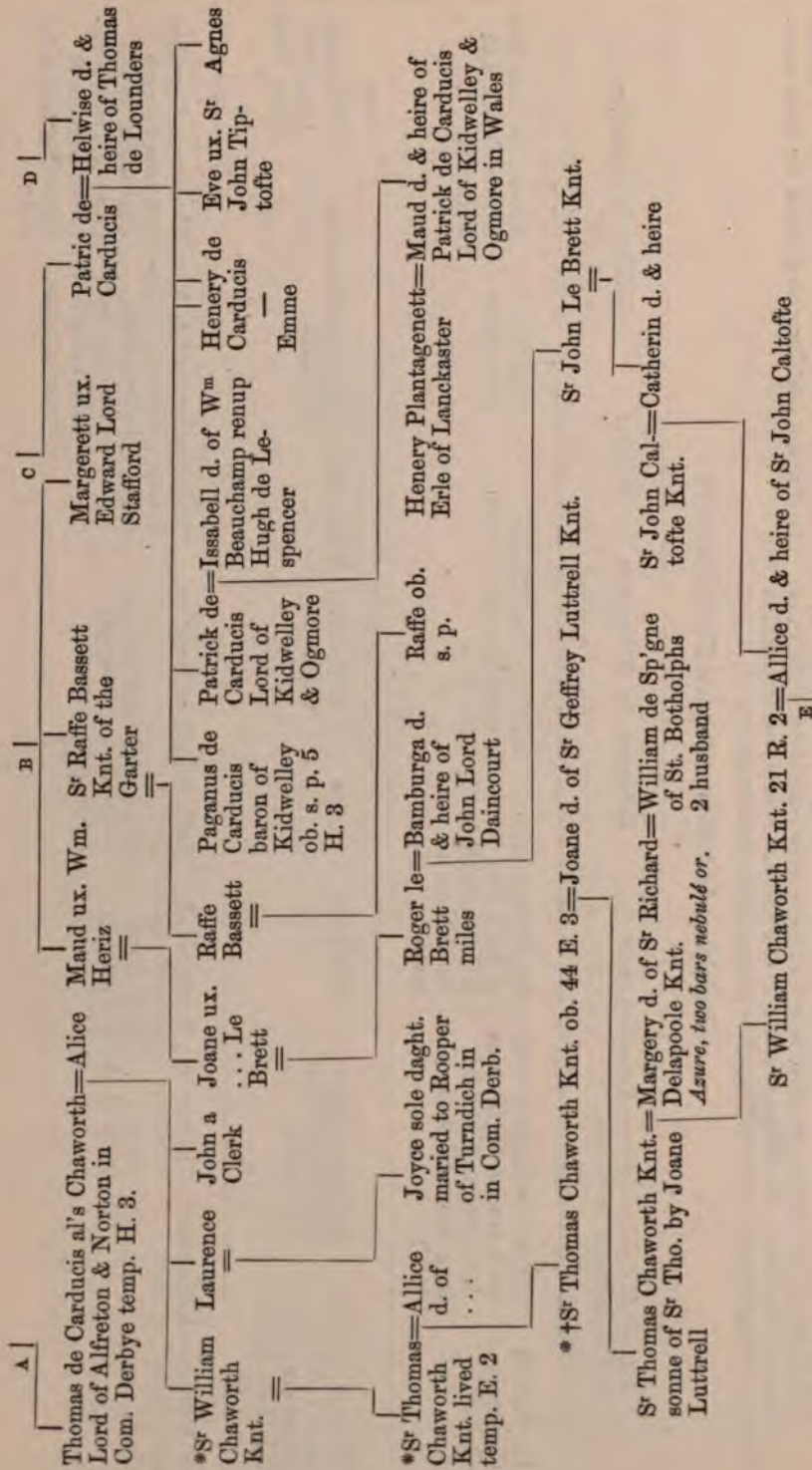

\* Omitted in Harl. 1400.

† This Thomas in his deed dated the 6 of E. 2 calleth Thomas his grandfather & himselfe sonn & heire of Wm. & his seale was the armes of his father with a labell.

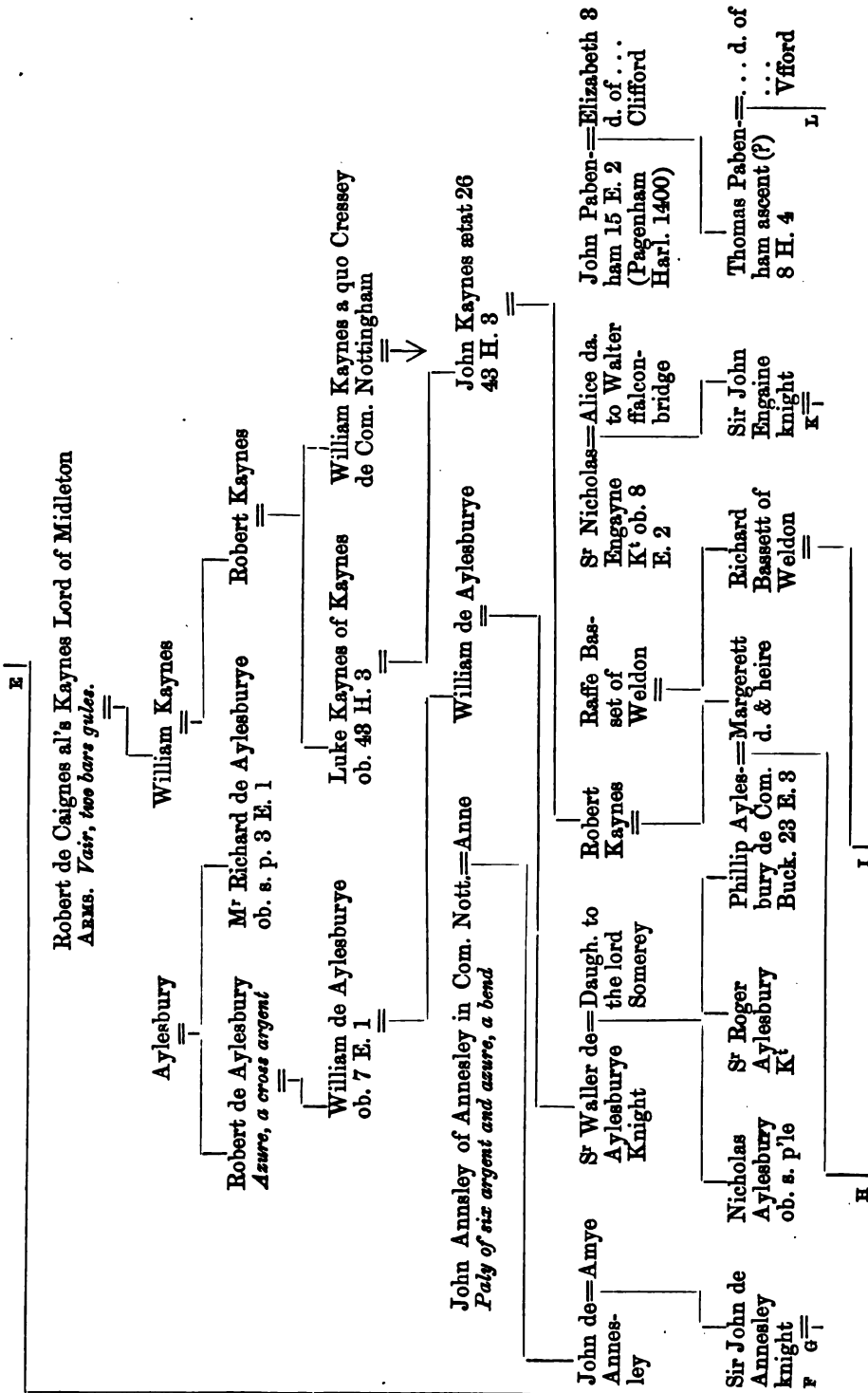



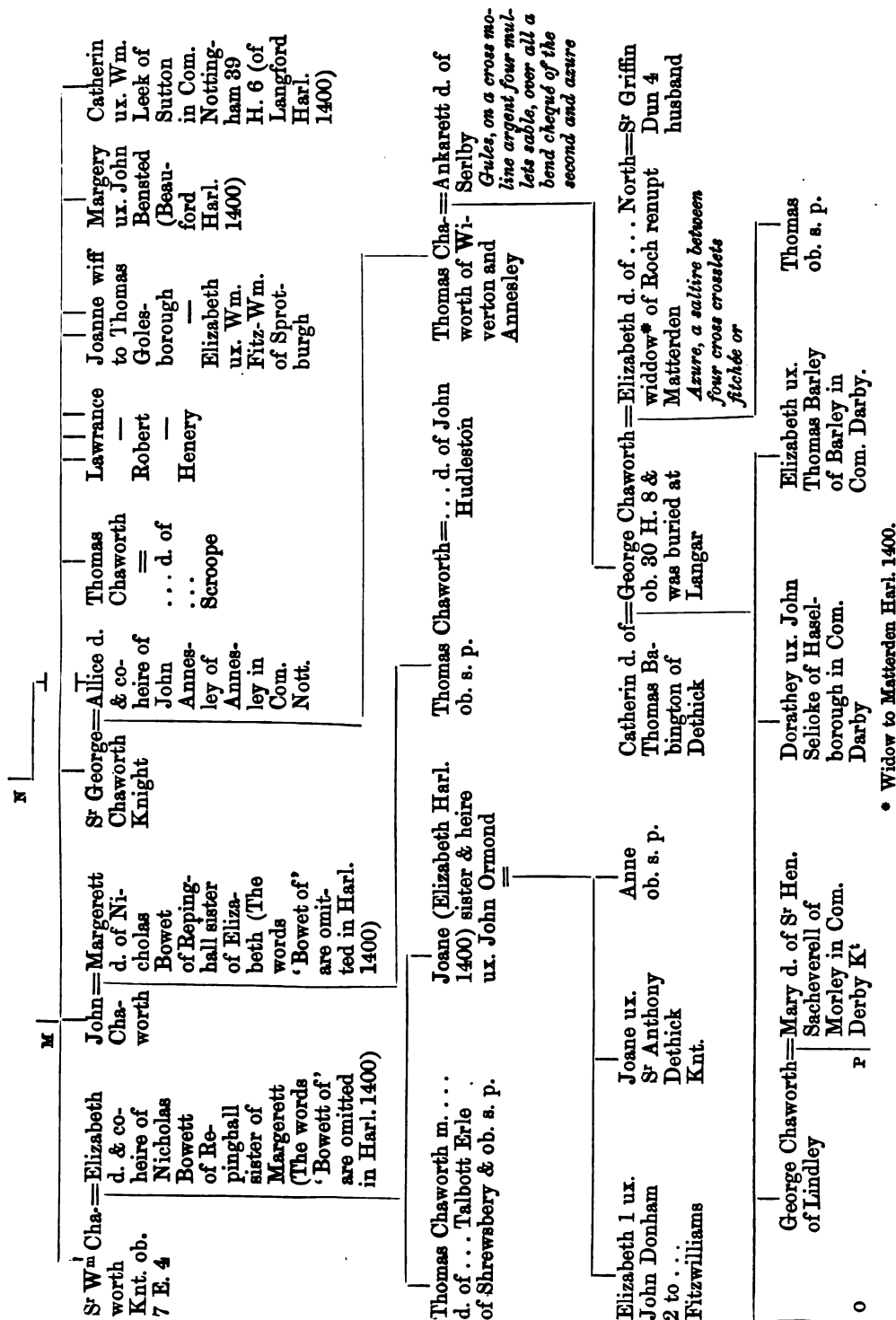

\* Widow to Matterden Harl. 1400.

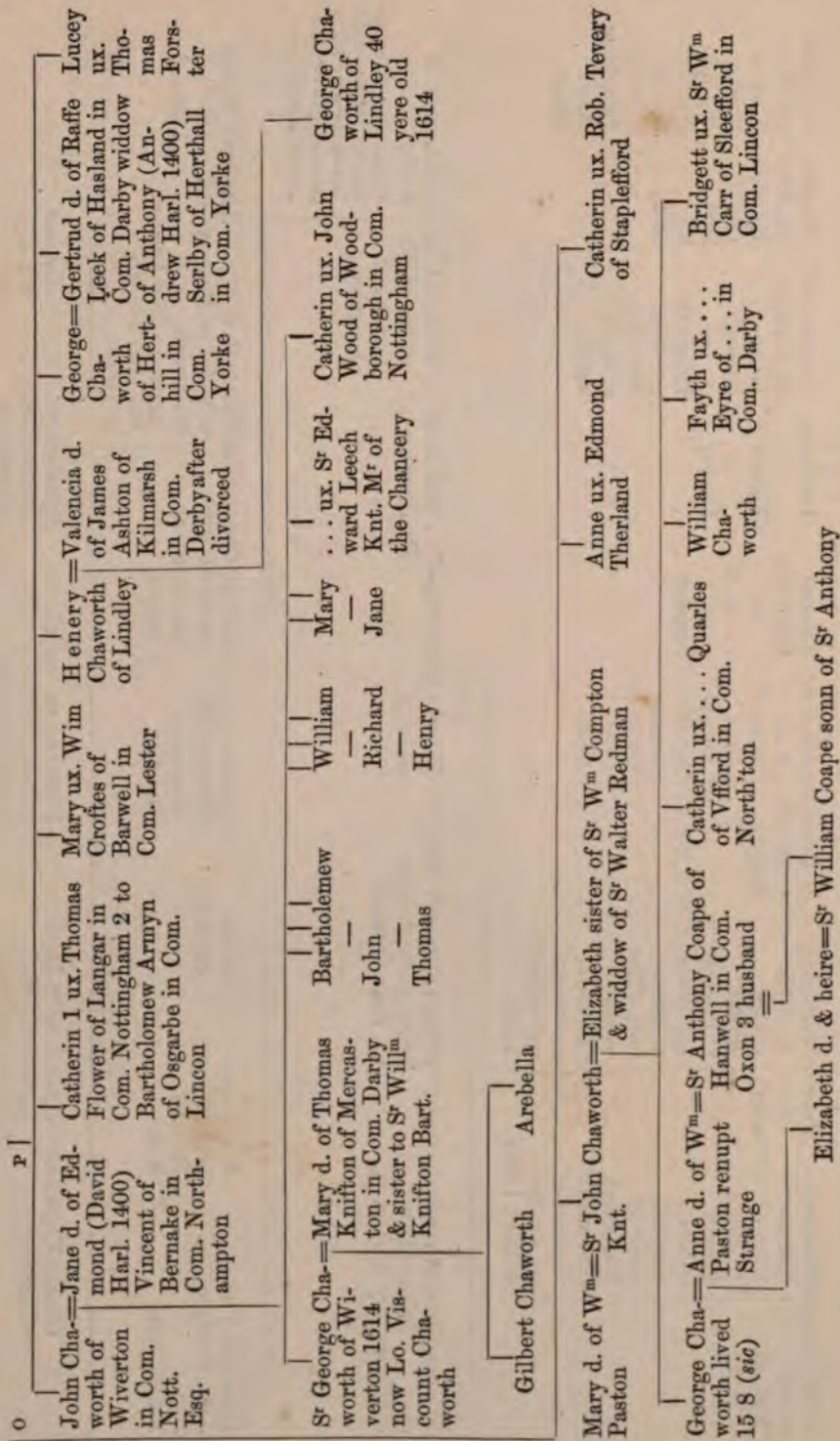

**Atkinson.**

ARMS. *Quarterly:—1 and 4. Argent, an eagle displayed gules, beaked and membered azure, on a chief of the last three bezants. ATKINSON. 2 and 3. Gules, a chevron engrailed between three dolphins embowed argent. CHIPENHAM.*  
 CREST. *A demi-eagle displayed or collared azure.*

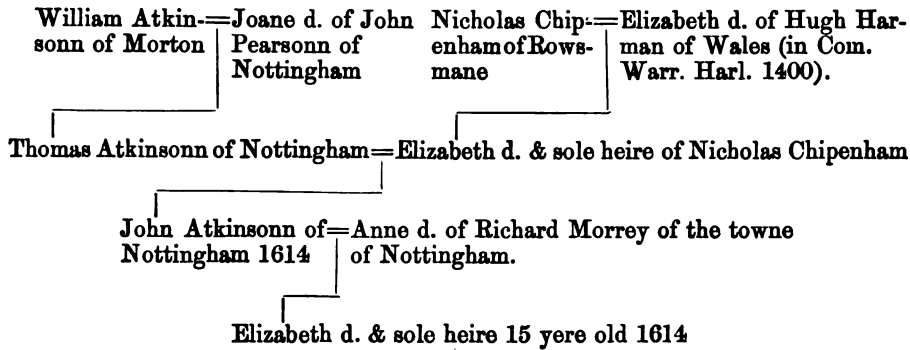

**Hynde.**

ARMS. *Gules, a chevron between three hinds or, a crescent argent for difference.*  
 CREST. *On a coronet or, a cockatrice or, comb and legs gules, charged with a crescent for difference.*

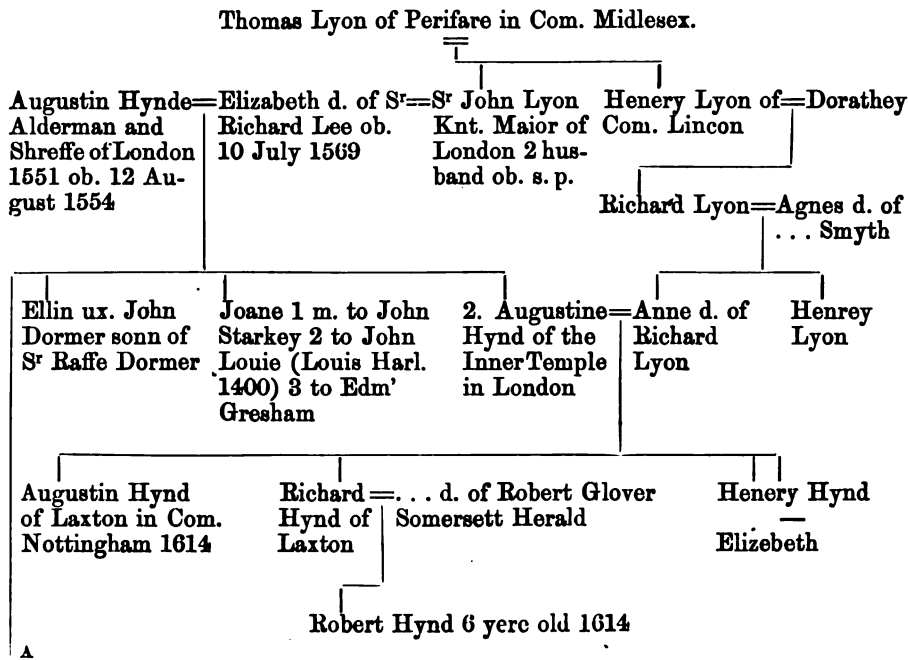

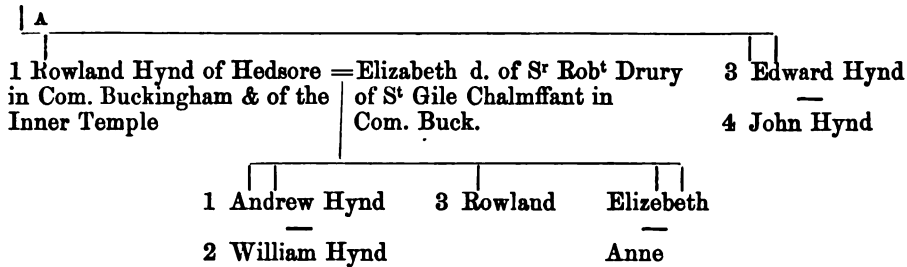

### Dobson.

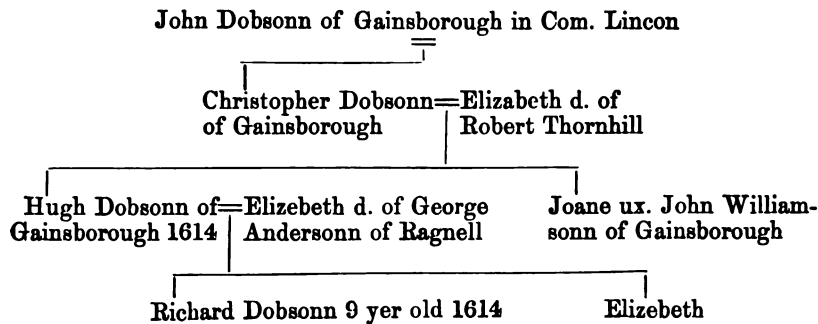

### Walker.

ARMS. *Argent three annulets within an orle of cinquefoils sable.*

CREST. *A buck trippant vert, attired or.*

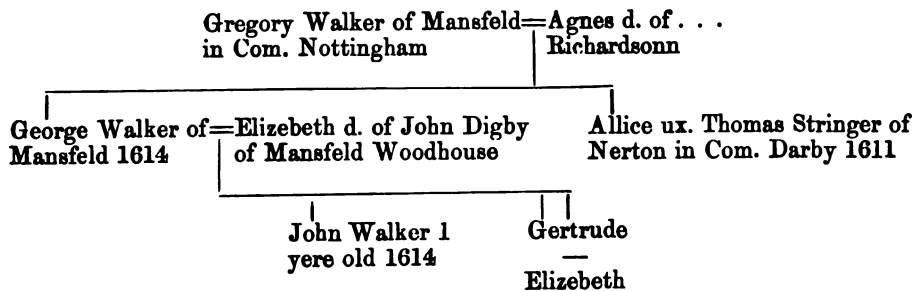



## Dande.

ARMS. *Vert a griffin segreant and in chief three escallops or.*

CREST. *On a mount vert a swan or, wings sable, beaked gules,*

The Armes and Crest was graunted to Rowland Dand A<sup>o</sup> 1575, 21 of Eliz.

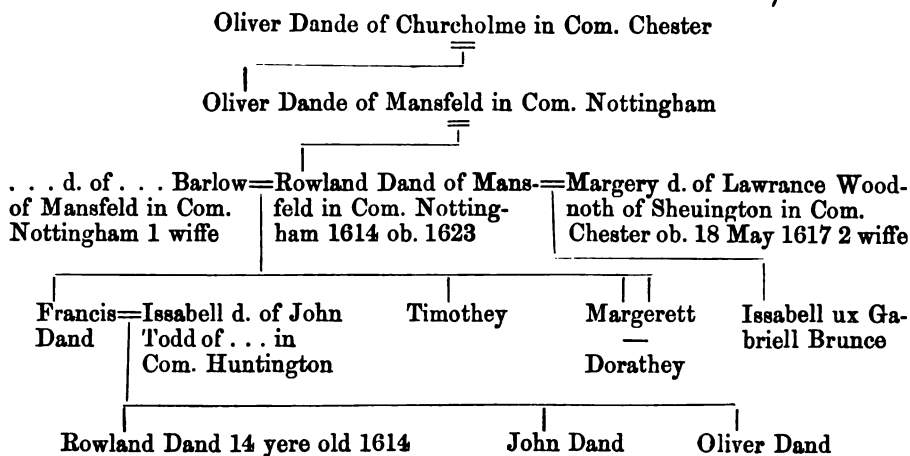

## Wightman.

ARMS. *Quarterly:—1. Per fess or and sable a maunch counterchanged. WIGHTMAN. 2. Gules on a chevron between three roses argent as many escutcheons of the field. WODAM. 3. Argent a cross pattée flory gules. TRUSSELL. 4. Azure on a chevron ermine three cross crosslets fitched sable. REYNOLDS.*

CREST. *On the stump of a tree proper a buck trippant argent, collared chained and attired or.*

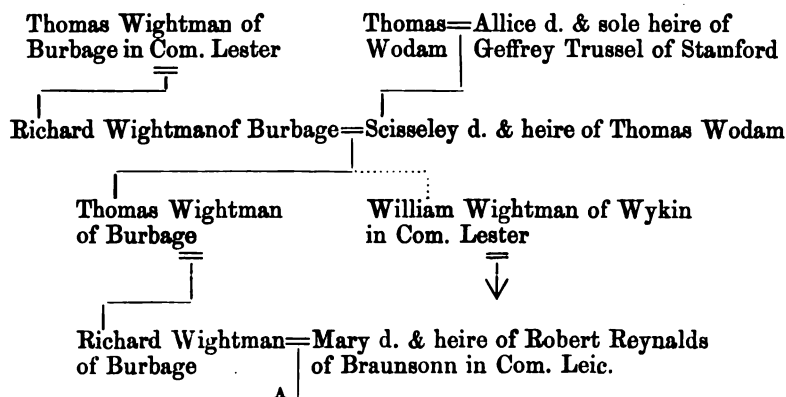

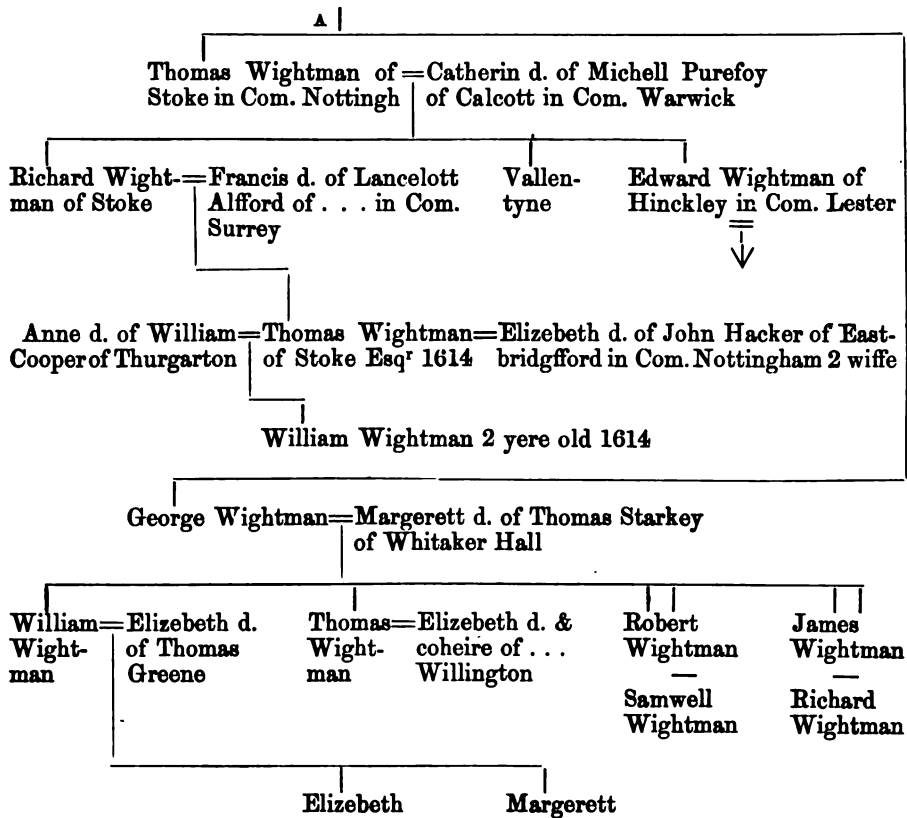

### Sherbrooke.

ARMS. *Vair, a chief or, on a bend gules three mullets of the second, a crescent for difference.*

CREST. *A horse's head erased argent, charged with three barrulets and maned gules.*

Robert Sherbrooke of Tixshall in Com. Derby.

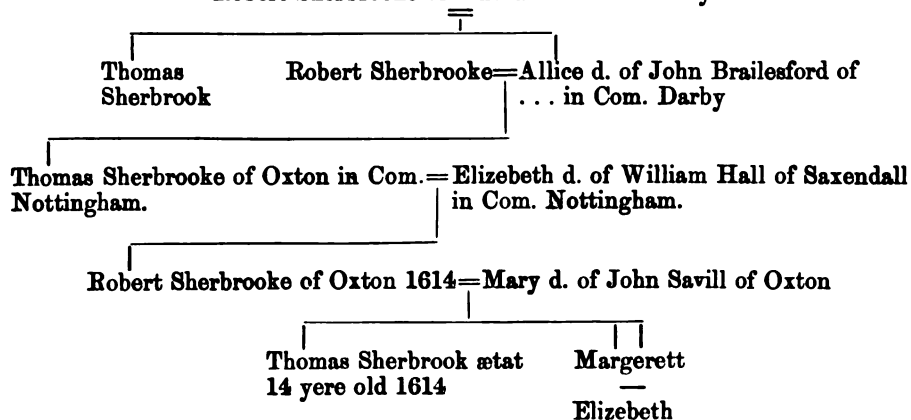

## Brookesby.

ARMS. *Barry, nebule of six, argent and sable, a canton gules.*

CREST. *A boar's head erect gules, tusked argent.*

In Harl. 1400 the canton is charged with a mullet or, and the ears of the boar's head are or, and this note "noe mullet in the visitacon in the canton."

John Brookesby of Sywoldby al's Sholdby in Com. Lester temp. E. 3.

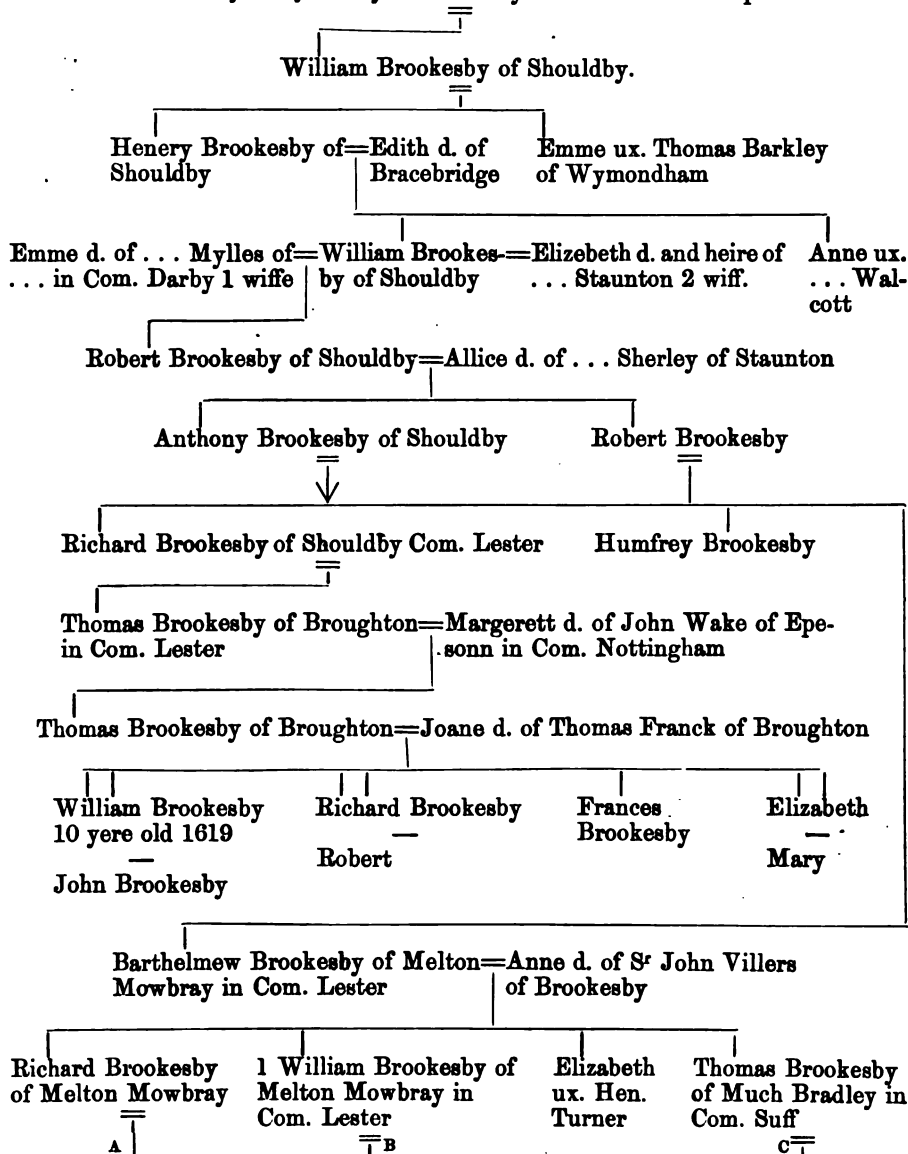

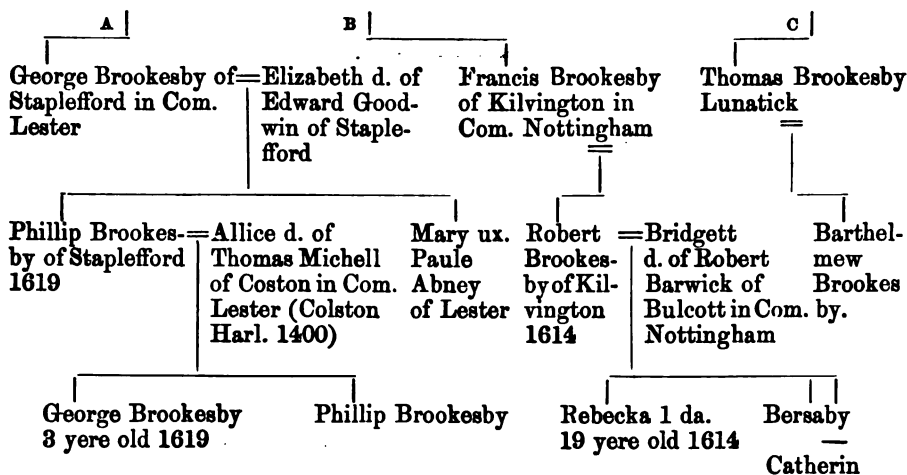

### Brome.

**ARMS.** Quarterly:—1 and 8. Sable, on a chevron argent three sprigs of broom vert. 2. Vert, fretty or. 3. Gules, on a fess azure between nine billets argent three lions passant or. 4. Azure, a fess dancettée between six escallops argent. 5. Argent, a lion passant paly or and sable between three dolphins embowed of the last, all within a tressure flory purpure. 6. Sable, three helmets argent. 7. Argent, an estoile gules.

**CREST.** A cock argent, wings elevated azure, beaked combed legged and wattled gules.

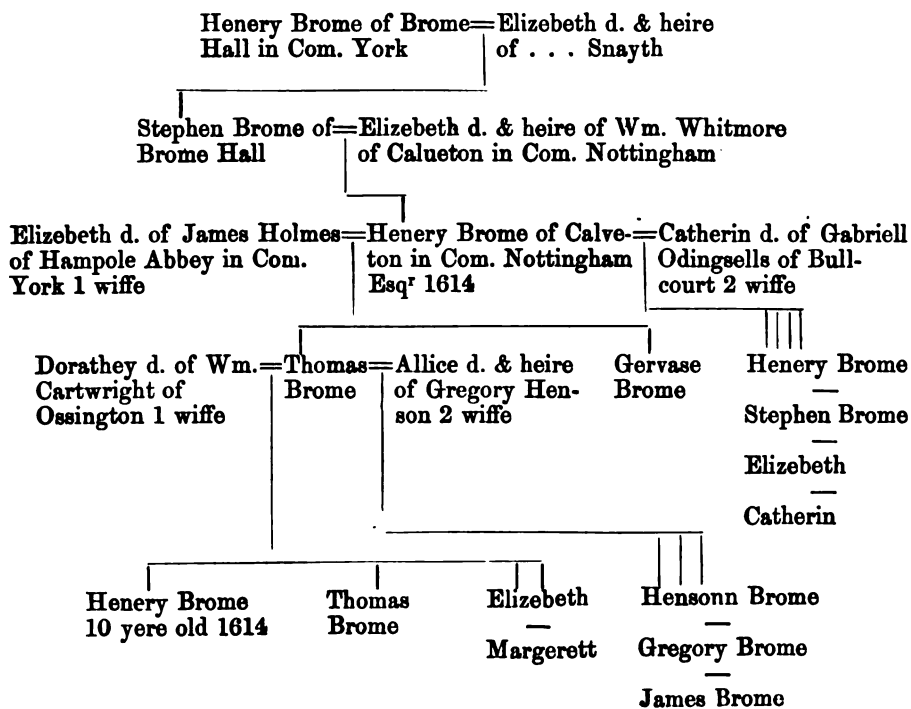

## Garnon.

ARMS. *Argent, a buck's head caboshed and in chief a mullet for difference gules.*

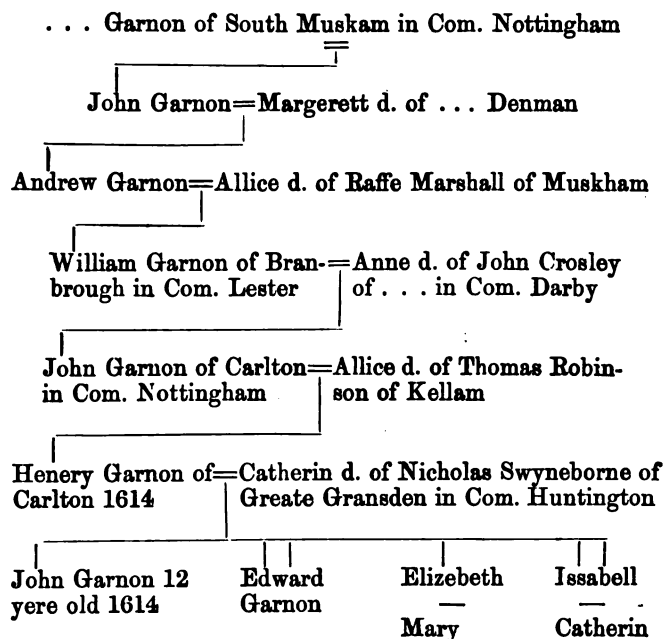

## Draper.

**ARMS. Quarterly:—**1 and 12. *Argent, on a fess between three annulets gules, as many covered cups or (a mullet between two covered cups Harl. 1400).* **DRAPER.** 2. *Argent, two chevrons between three escallops sable both charged with as many martlets or.* **DRAPER.** 3. *Ermine on a chief azure three lions rampant or.* **AGER.** 4. *Ermine, a fess chequé or and azure.* **UNSWICK.** 5. *Gules, a chevron between three swans' heads erased argent.* **GOULSTON.** 6. *Or, on a fess sable a lion passant guardant argent.* **HUSSEY.** 7. *Argent, three bendlets enhanced gules.* **BYRON.** 8. *Argent, a fess between six martlets sable.* **FLINTHAM.** 9. *Sable, a fess dancette surmounted of three fleurs-de-lis or.* **ELLA or ELLER.** 10. *Or, on a fess gules three water bougets argent.* **BINGHAM.** 11. *Ermine, a fess gules.*

**BERNAKE.**

**CRESTS.** 1. *A cubit arm erect habited vert slashed and cuffed argent, holding in the hand proper a covered cup or.* 2. *A buck's head sable, attired argent, charged on the neck with two barrulets between three annulets or.* 3. *An arm embowed in armour argent garnished or, holding in the hand proper a grappling-iron gold.*

John Draper of Flintham in Com. Nottingham=Sibbell

John Draper of Flint=Elizebeth d. of . . . Wymond-  
ham in Com. Nott- ham of Claxton in Com. Nott-  
ingham 9 H. 5 ingham (co. Leic. Harl. 1400)

Thomas Draper=. . . d. & heire of  
of Flintham Henry Ager

Hugh Ager=. . . d. & heire  
(Henry of . . . Vrswick  
Harl. 1400)

Sr Hugh Hussey of Flint-  
ham in Com. Nottingham

Henry Hussey=. . . d. of John Meth-  
of Flintham ley of Eliston

Thomas Draper of Flintham=. . . d. of . . . Kettleby

Robert Draper=Elizebeth d. & coheire  
of Camberwell of John Fifeild al's  
in Com. Surrey Lowe of London

John Draper of Mel=. . . d. of . . .  
ton Mowbray in Com. Gunston  
Lester son & heir

John Hussey of=. . . d. of . . .  
Flintham Revell

William Hussey of Flintham=. . . d. of William Staunton

Mathew Draper of Cam-=Dionis d. of William  
berwell in Com. Surrey Blackwell of Cam-  
son and heire of Robert berwell

John ob. s. p.  
Henry ob. s. p.

William  
ob. s. p.

Elizebeth ux. John Bennett ux. John  
Bowyer of Cam- Faramond  
berwell B T

A

C

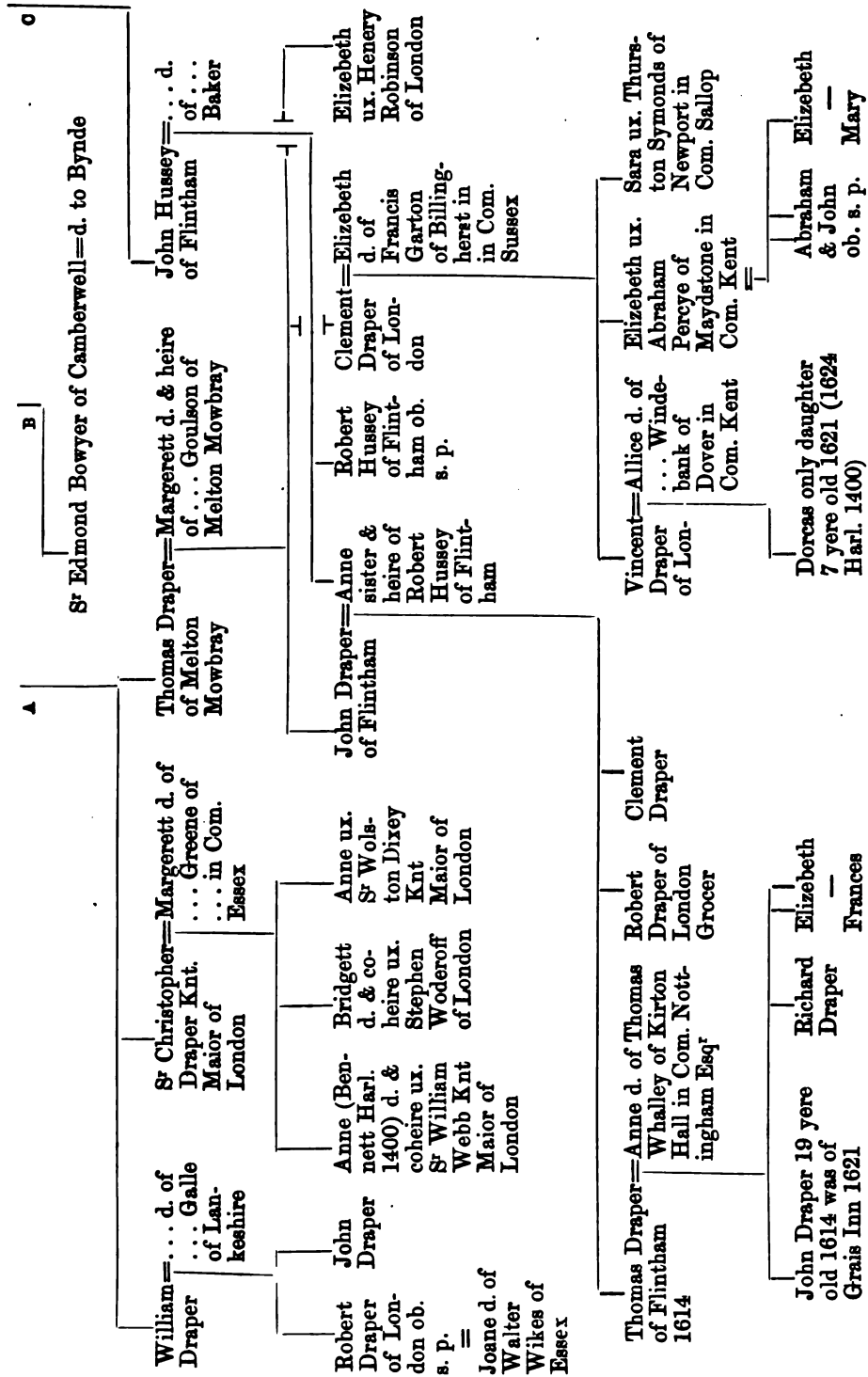

## Vincent.

ARMS. *Quarterly* :—1. *Azure, three quatrefoils argent.* 2. *Barry nebulé of four or and gules, on a chief argent three birds sable.* 3. *Argent, a chevron sable between three boars' heads gules, a bordure engrailed.* 4. *Argent, a cinquefoil azure.* 5. *Quarterly, 1 and 4. Or, three piles meeting in base gules a canton vair.* 2 and 3. *Or, a fess gules.* 6. *Or, fretty sable.*  
 CREST. *A demi-ram sable, collared and armed or.*

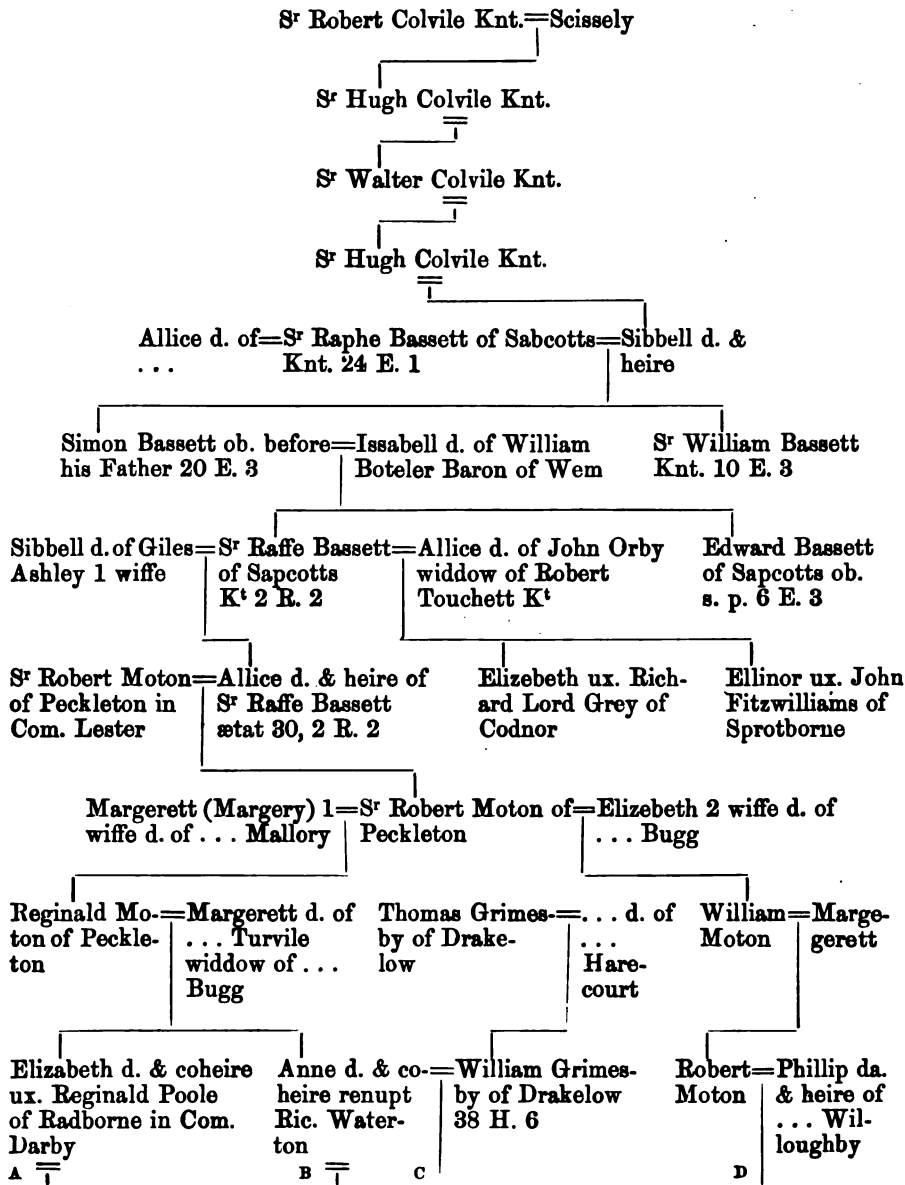



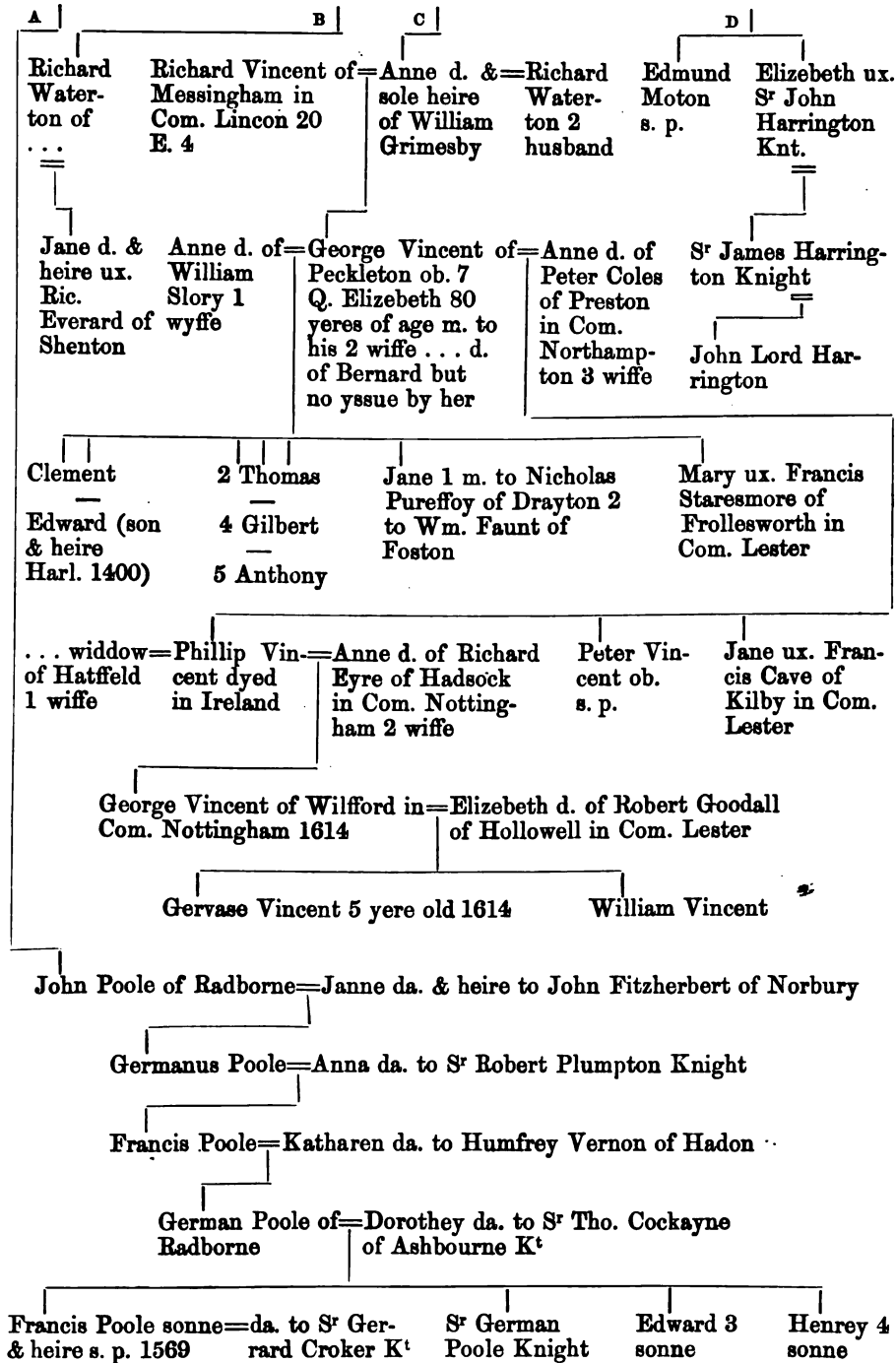

## Brendisley.

ARMS. *Per pale or and sable, a chevron between three escallops counterchanged.*

CREST. *An escallop per pale or and sable.*

Per WM. FLOWER NORROY.

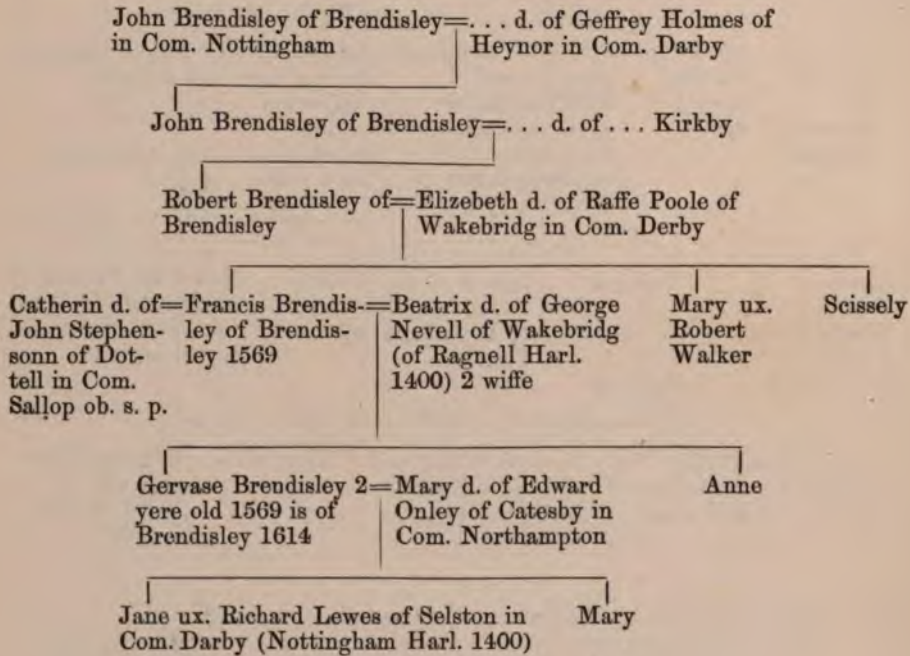

## Cooper.

ARMS. *Quarterly:—1 and 4. Azure, on a chevron engrailed argent between three cinquefoils ermine two lions respectant sable. COOPER. 2 and 3. Argent, on a chevron engrailed gules between three martlets azure collared or, as many cinquefoils argent. TOLLEY.*

CREST. *A demi-man, his dress divided quarterly and counterchanged argent and sable, his sleeves slashed, and holding in his dexter hand a covered cup or, his face swart, wreathed round the temples or and azure, on his head a cap of the last.*

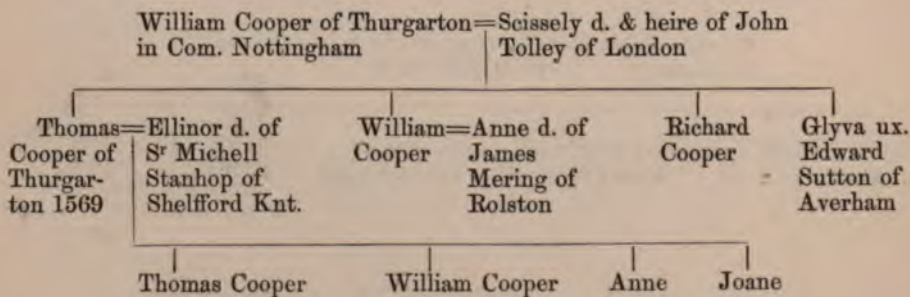

## Sutton.

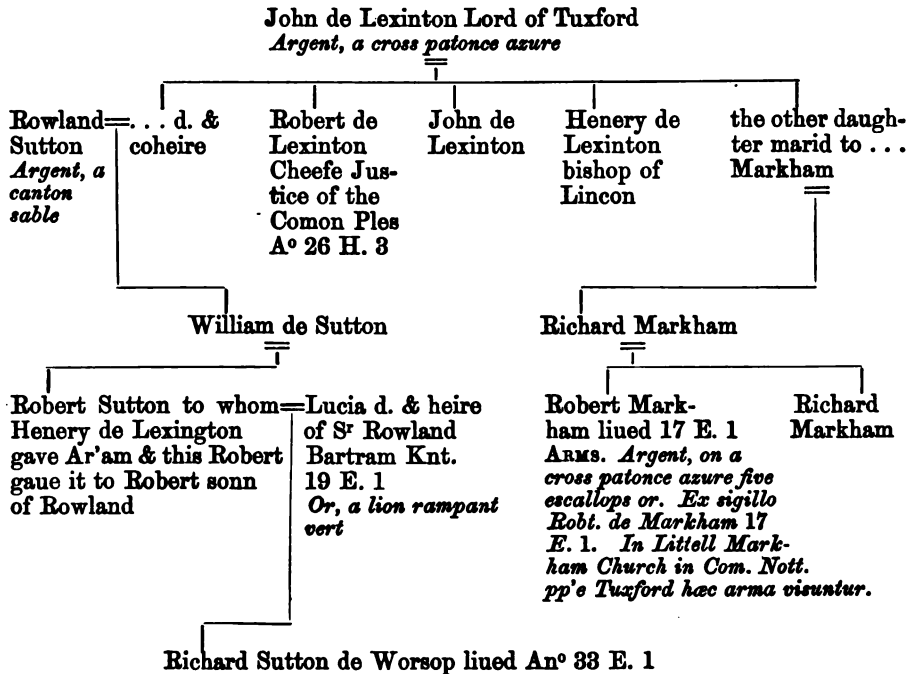

Ex sigillo Robt. de Markham 17 E. 1. In Littell Markham Church in Com. Nott. pp'e Tuxford hæc arma visuntur.

Ricardus Sutton de Warsope p' charta' sua' dat' a° 33 Regni Rg' Ed' dedit Agnetæ quæ fuit uxor Jacobi de Sutton maritag' Rici' filij et hæredis Jacobi quonda' viri sui quod quidem maritagi' contingebat dn'o Ric'o Sutton de Warsope one' quor'da' ten'tor's quæ præd'c'us Jacobus pater p'd'ci Ric'i cuius hæres ip'e est de dc'o Ric'o tenuit in Dene p' seruitiu' militare cui quidem chartæ anexu' erat sigillum armor' Dc'i Ric'i Sutton de Warsope tale quale hic depinxi.

SEAL. A round seal, on a shield *A lion rampant*, with the legend, SIGILLVM RICARDI DE SVTTON.

Rolandus Bartram miles dedit Lucis filis suæ uxori Rob'ti de Sutton omnia maneria t'r'as et ten'ta suas in Com. Lincoln et Nott. et hæred' suis et in reuersione Isabellæ sororis suæ et hæredibus Isabellæ Dat' apud Lincoln 19 Rg' Edwardi Hijs testibus, Ric'o Neuill de Beekeby milite, Johe' de Skipwith de eadem milite, Rob'to de Archubus de Warnby milite, cum multis alijs.

SEAL. A round seal, on a shield *A lion rampant*, with the legend SIGILLVM ROLANDI DE BERTRAM.

## Sutton.

ARMS. *Quarterly*:—1 and 8. *Argent, a canton sable.* SUTTON. 2. *Or, a lion rampant vert.* BARTRAM. 3. *Argent, a cross patonce azure.* LEXINGTON. 4. *Gules, three pickaxes argent.* PIGOTT. 5. *Or, on a fess gules three water bougets argent.* BINGHAM. 6. *Argent, a bend gules, a bordure engrailed of the last.* MASTERS. 7. *Or, three eaglets purpure.* RODNEY.  
 CREST. *A fox's head erased gules.*

The following is given in Harl. 1400 for Sutton Lord Lexington impaling Palmes:—  
*Argent a canton sable; -impaling, Gules, three fleurs-de-lis argent, a chief vair.*  
 SUPPORTERS. *Two lions vert.* MOTTO.—“AS GOD WILL.”

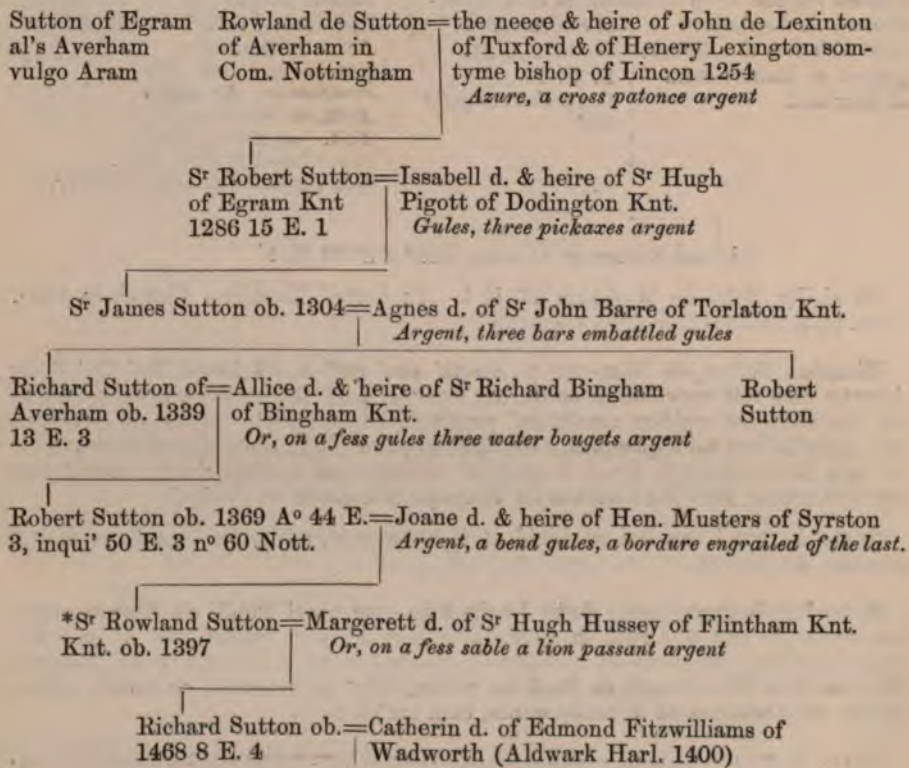

\* In Harl. 1400 Sir Roland is made to marry Katheren da. to Sir Henry Hasty and to have a son Henry, who died 1416, married to Margaret Hussey, their son being Richard, who married Catheren Fitzwilliams.

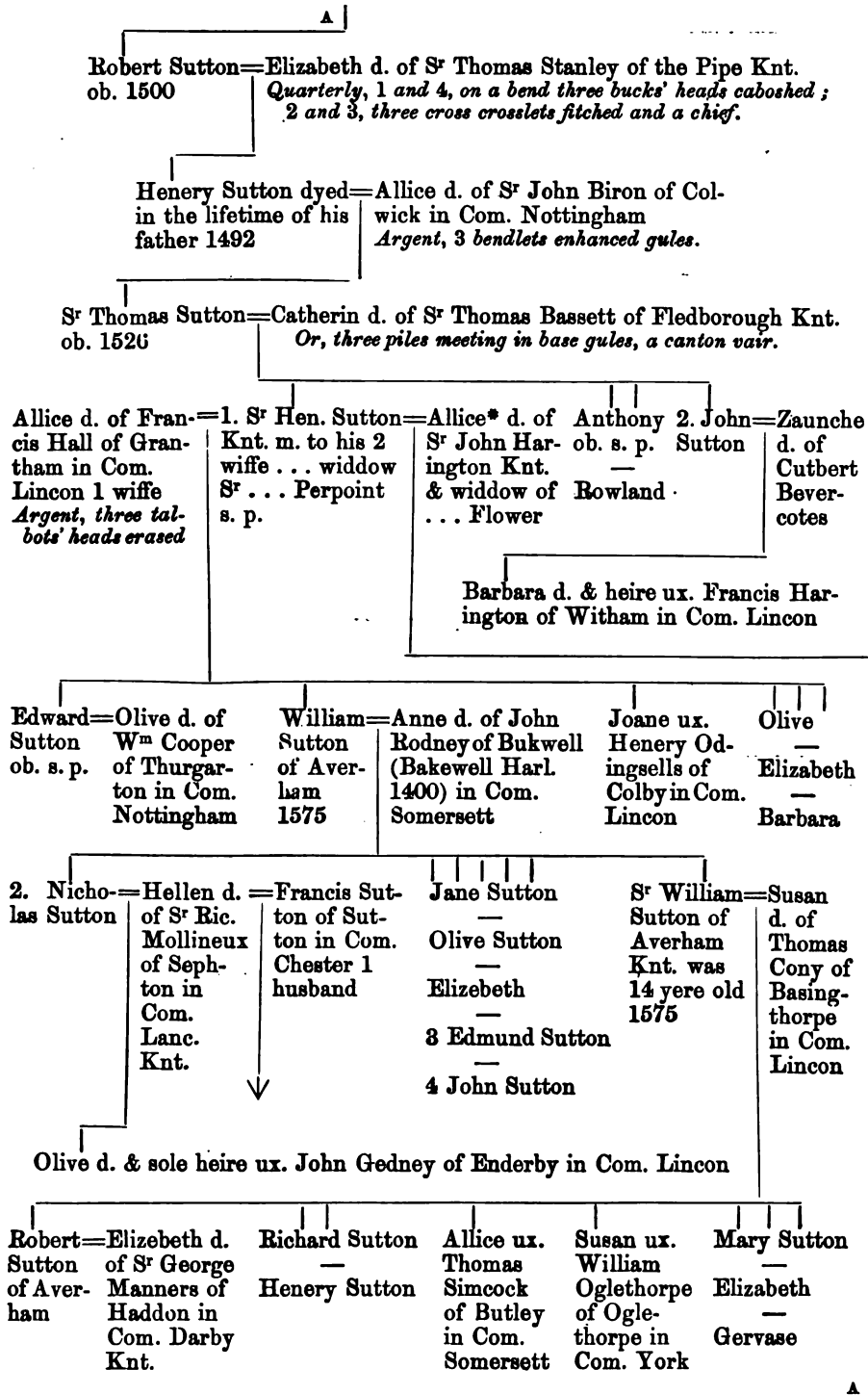

\* All the children are to the first wife in Harl. 1400.

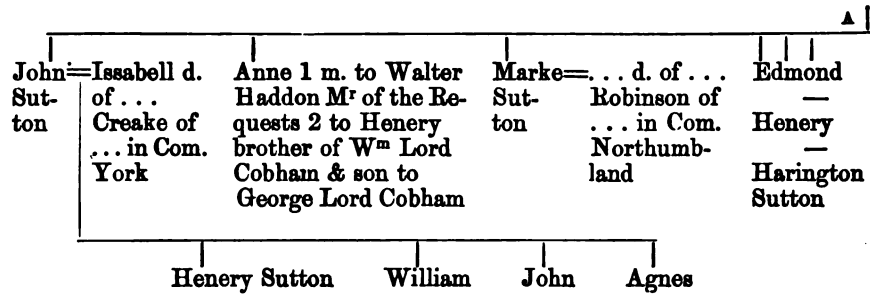

### Bingham.

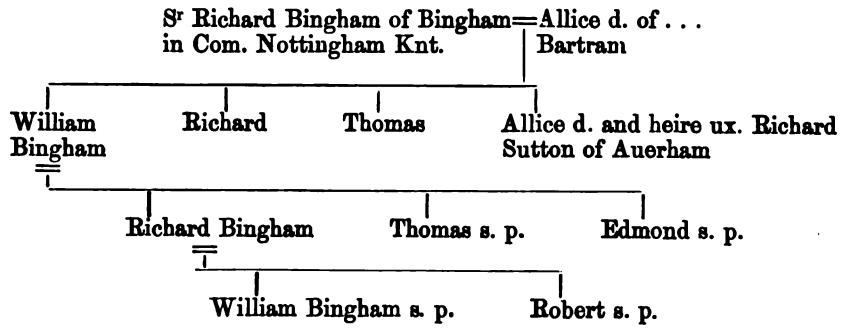

**Willoughby.**

ARMS. *Quarterly* :—1. Or, on two bars gules three water bougets argent. WILLOUGHBY. 2. Or, a cross patonce gules. FREVILE. 3. Vair, a canton ermine. FILLIOLL. 4. Azure, a fess between three eaglets displayed argent. FIELD.  
 CRESTS. 1. A gryphon argent. 2. An owl argent, crowned and legged or.  
 ANOTHER COAT. *Quarterly* :—1. WILLOUGHBY as before. 2. FREVILE as before. 3. Vair, a fess gules. MARMION. 4. Sable, a sword-point downwards argent, pomel and hilt or. KILPECK. 5. Bendy of eight or and azure. MOUNTFORD. 6. Argent, billettee and a lion rampant sable, crowned or. DELAPLANCHE. 7. Azure, a fess between six crosses crosslets argent. HAYESHAM. 8. Or, a saltire engrailed sable. BOWTOFT. 9. Gules, ten bezants 4, 3, 2, and 1. ZOUCH. 10. FILLIOLL as before, but the canton gules. 11. Azure, crussilly and a lion rampant or, charged on the shoulder with a fleur-de-lis gules. BREWSE. 12. Field as before, but the fess or.

William Willoughby of Willoughby\* vpon the Wold in Com. Nottingham temp. E. 1

Sr Richard Willoughby of Willoughby\* Knt. A<sup>no</sup> 5 E. 2

Sr Richard Willoughby of Willoughby Knt. on=Isabell d. of Sr Roger Mortein Knt. Lord of Dunesley of the Justices of the Comon Bench  
*Or, six lioncels rampant sable.*

Sr Richard Willoughby of Willoughby Knt.=Joane d. of the Lord Gray of Rotherfeld

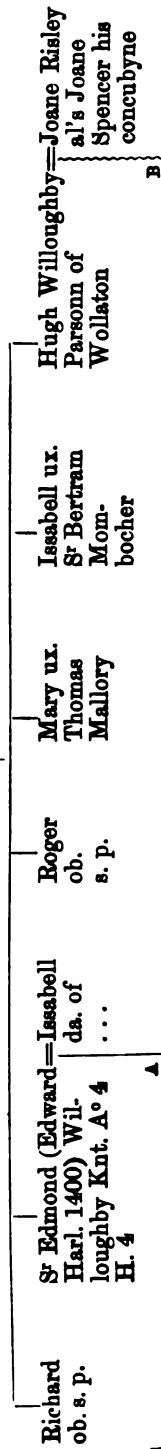

\* Wolverton Harl. 1400.

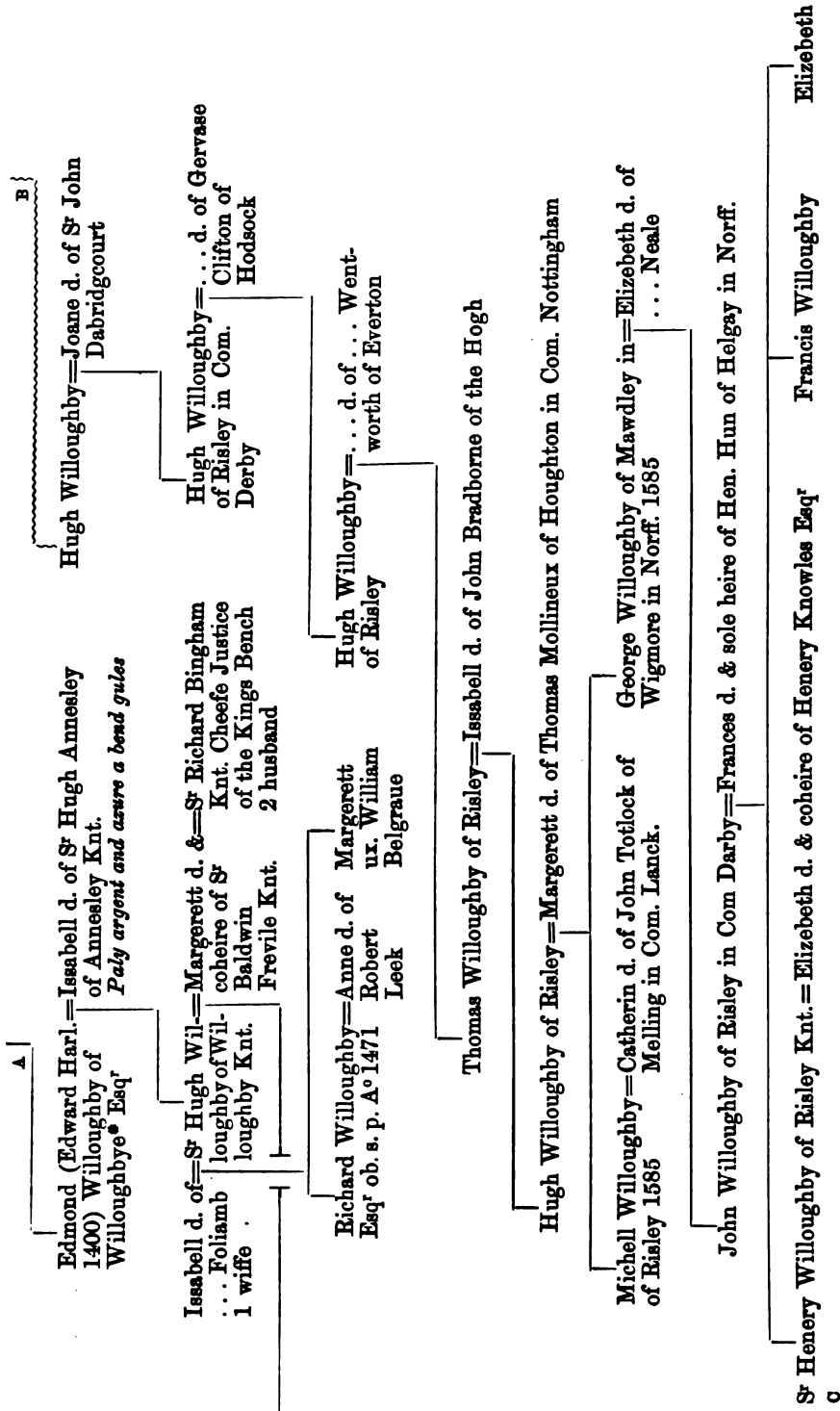

• Wolverton Harl. 1400.



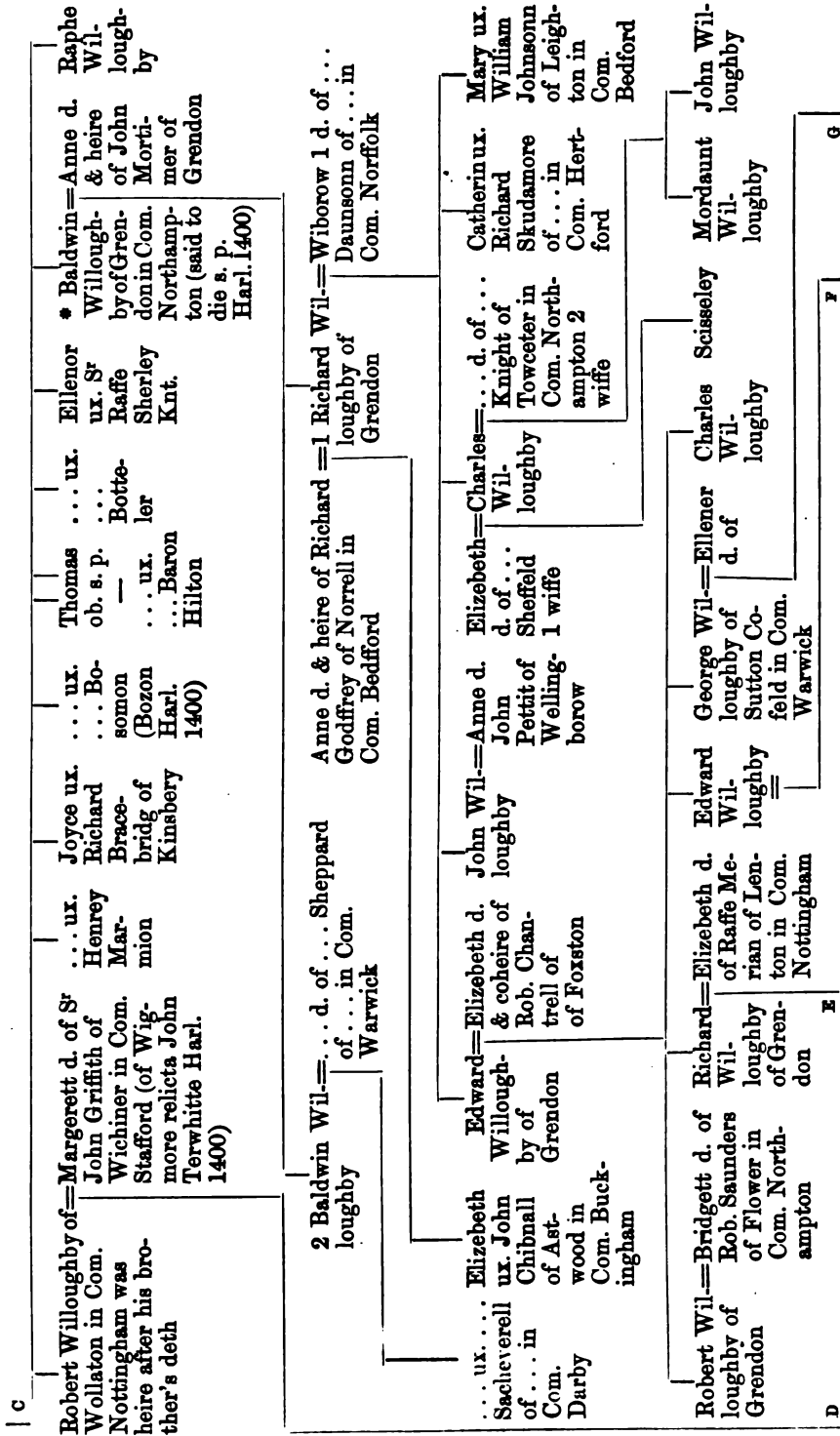

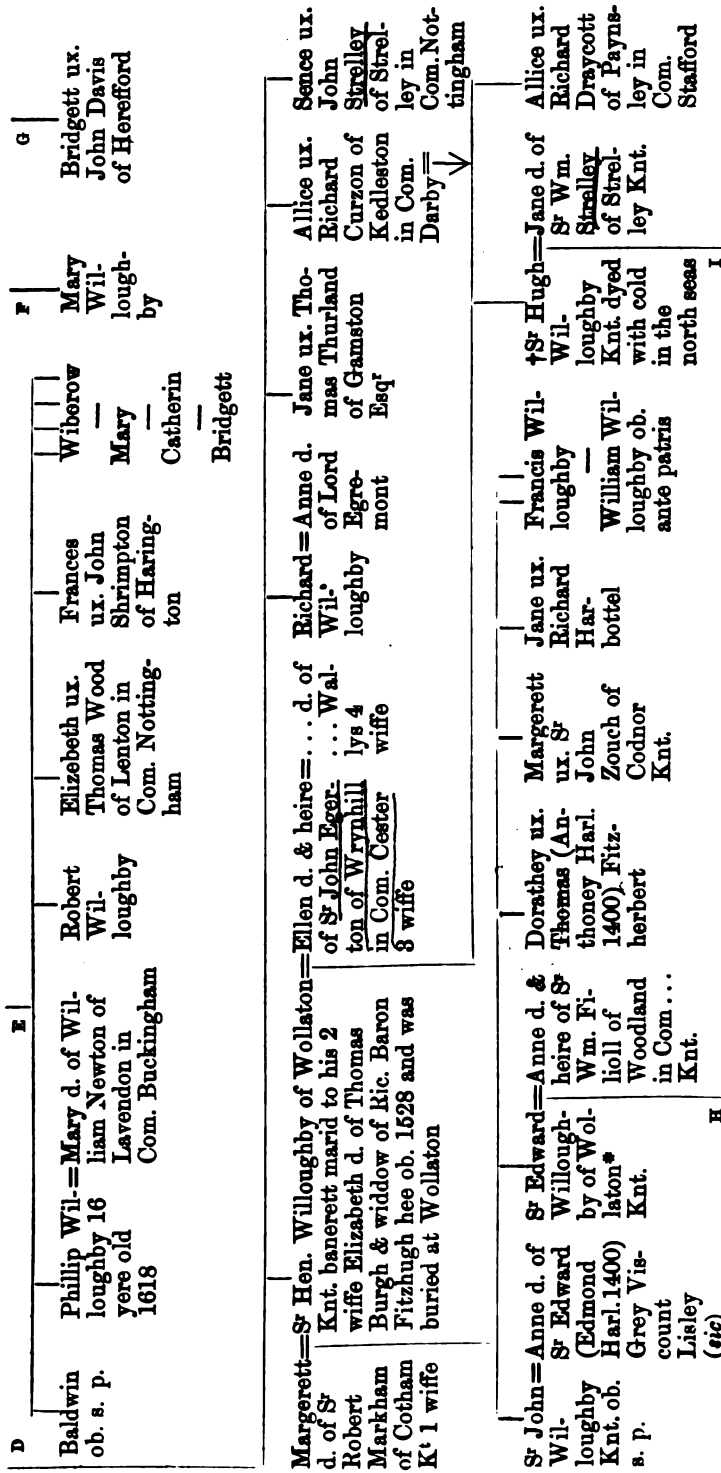

\* Wolverton Harl. 1400.  
 † In mare septentrionali dum navigarat versus in Muscoviam et Russia.

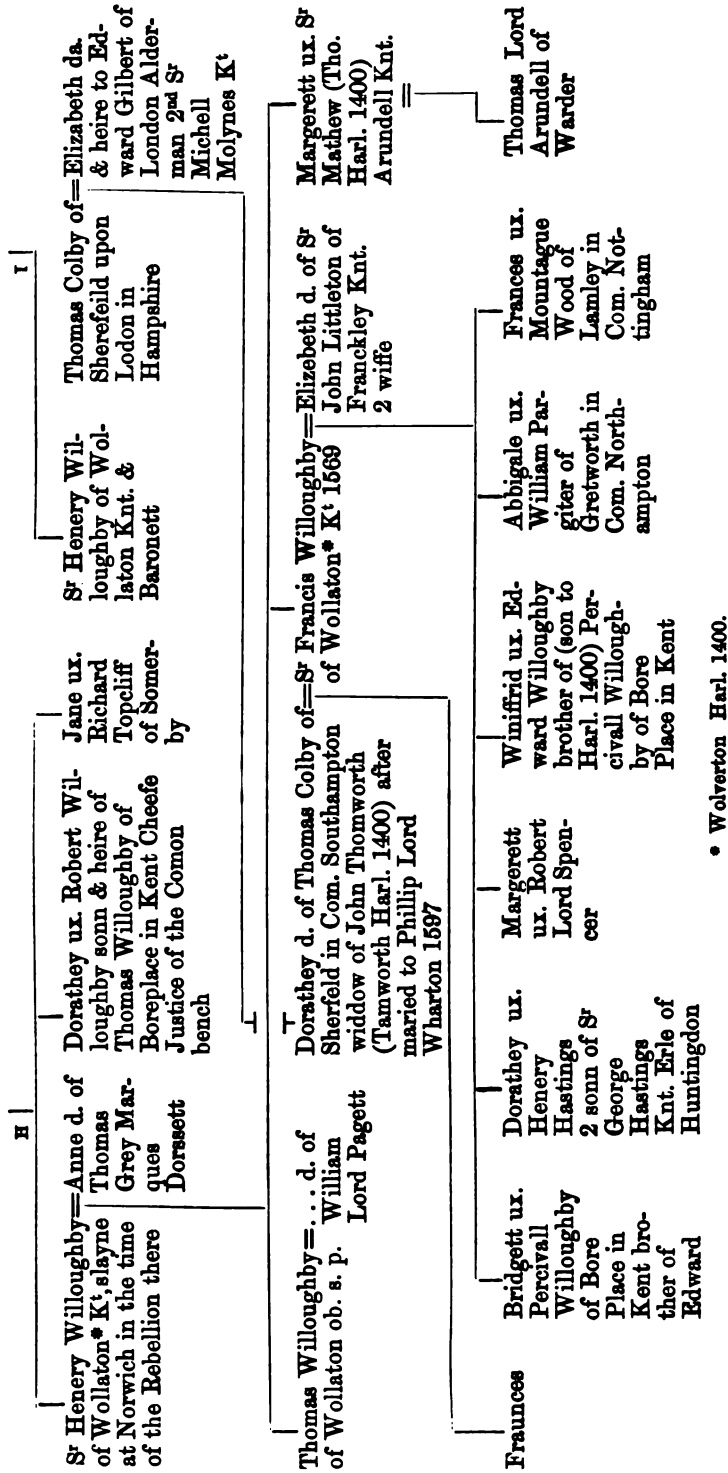

## Babington.

ARMS. *Quarterly*:—1. *Argent, ten torteaux, a label azure.* 2. *Or, a fret azure.* 3. *Argent, a fess vairé or and gules, between three water bougets sable.* 4. *Argent, a chief gules, on a bend azure three shields of the first having a chief of the second.* 5. *Or, a chevron gules and a canton ermine.* 6. *Or, on a chief indented azure, three escallops argent.* 7. *Barry of ten argent and gules, an orle of martlets sable.* 8. *Azure, two chevrons or.* 9. *Argent, an inescutcheon within an orle of ten cinquefoils sable.* 10. *Gules, a fess dancetté between ten billets or.* 11. *Azure a hedgehog or.* 12. *Or, three piles meeting in base gules, a canton ermine.* 13. *Azure, a cross argent.* 14. *Vair, three bars gules.* 15. *Argent three pallets gules, a bordure azure charged with ten bezants.* 16. *Argent, three bucks' heads caboshed sable, on a bend gules, three mullets or.* 17. *Gules, a fess dancetté between six cross crosslets or.* 18. *Argent, three bucks' heads caboshed sable.* 19. *Gules, ten bezants, a canton ermine.* 20. *Sable, fretty or.* 21. *Quarterly ermine and gules.* 22. *Vert, three greyhounds courant or.* 23. *Sable, a bend between six cross crosslets argent.* 24. *Argent, three salieres sable, a crescent for difference gules.*

CREST. *A dragon's head with a scroll issuing from its mouth, between two dragons' wings gules.*

Sr Bernard Babington Lord of Over Babington and Nether Babington in Com. Northumberland (Derbye Harl. 1400)

\*Sr John Babington made a knight in the service of E. 3., being cheefe captaine of Morles in Brittain

Sr John Babington Knt. = Benedicta d. & heire of Simon Ward of Com. Cambridg

*Or, a fret azure.*

\* This Sr John Babington, Knt., lyeth buried in the monestary of the Fryers of Morleas, upon whose monument are these armes:—Argent, ten torteaux 4, 3, 2, & 1, a label azure.

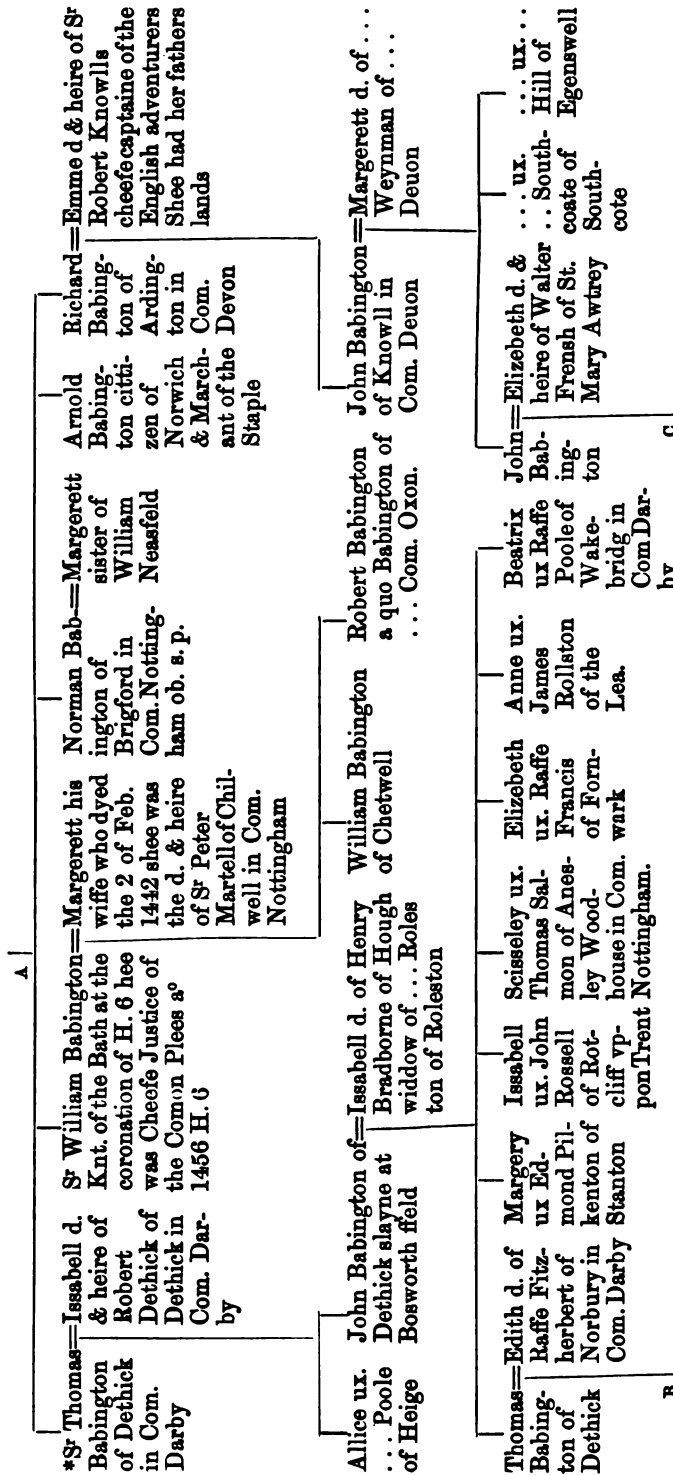

\* This Thomas Babington could his patrimony in his youth web. hee had in Brigford at Brigford vpon the hill in Com. Northampton, and after serued in the Battell of Agencourt with King H. 5. His Sword and Bow that hee bare that day are yett at Dethick to be seene; hee returned home at the age of 68 and bought the mannor of Kingeton in Com. Nottingham to him and his heires.

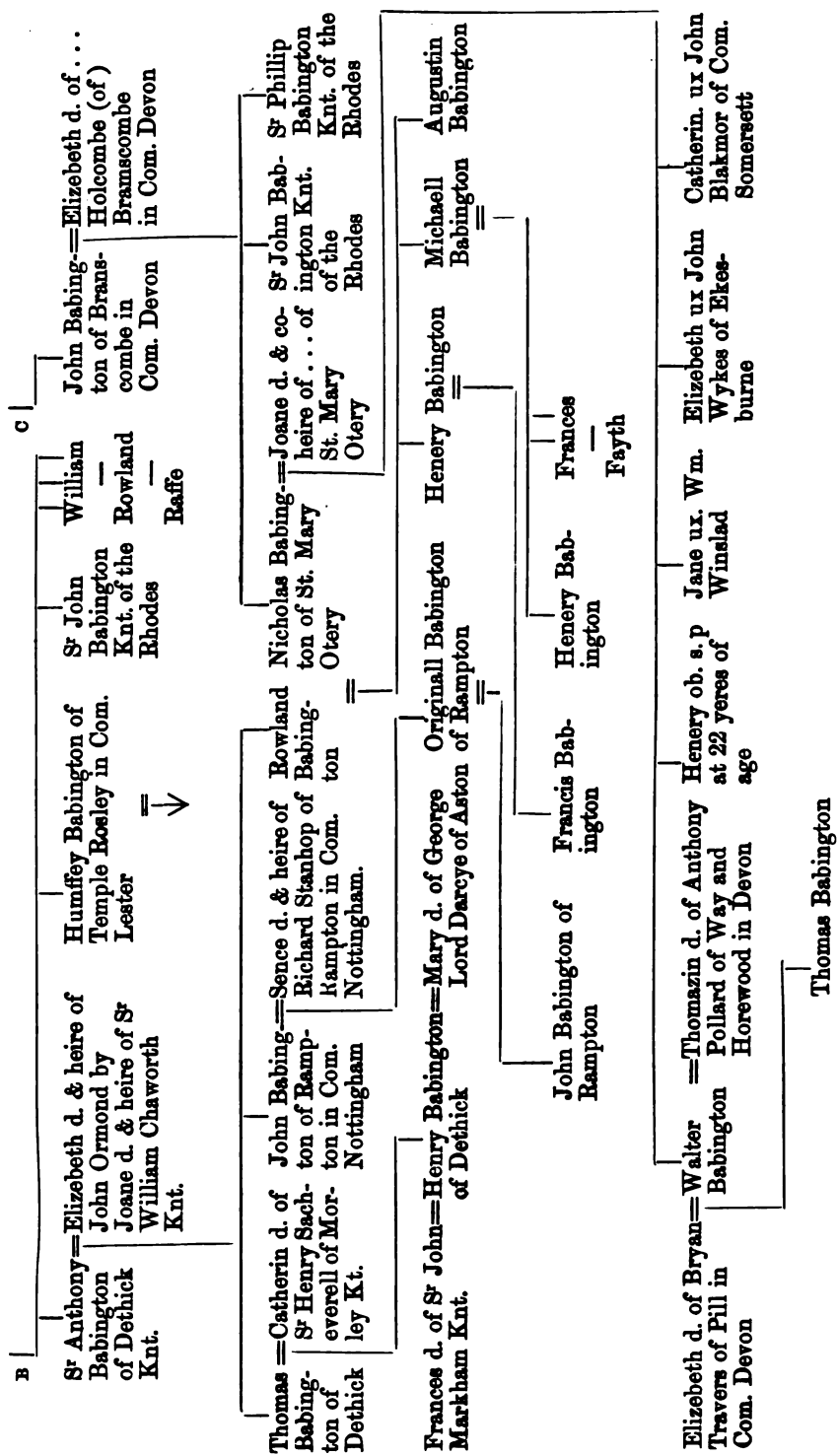

## Haselrig.

ARMS. Quarterly:—1 and 9. *Argent, a chevron sable between three hazel leaves vert.*  
 HASLERIG. 2. *Argent, three squirrels sejant gules.* SWARLAND. 3. *Argent, two bars and in chief three cinquefoils azure.* ESSINGTON. 4. *Azure, a bend cotised between six crosslets fitchés or.* BLAKETT. 5. *Argent, a maunch sable, a martlet for difference.* HASTINGS. 6. *Argent, the leopards' heads jessant de lis sable.* SADINGTON. 7. *Argent, a cinquefoil sable.* MORIVALE. 8. STANTON, *vairé argent and sable, a canton gules.*

CREST. *On a chapeau gules turned up ermine a man's head in profile proper, crined and bearded or.*

The coat and crest are both charged with a crescent for difference.

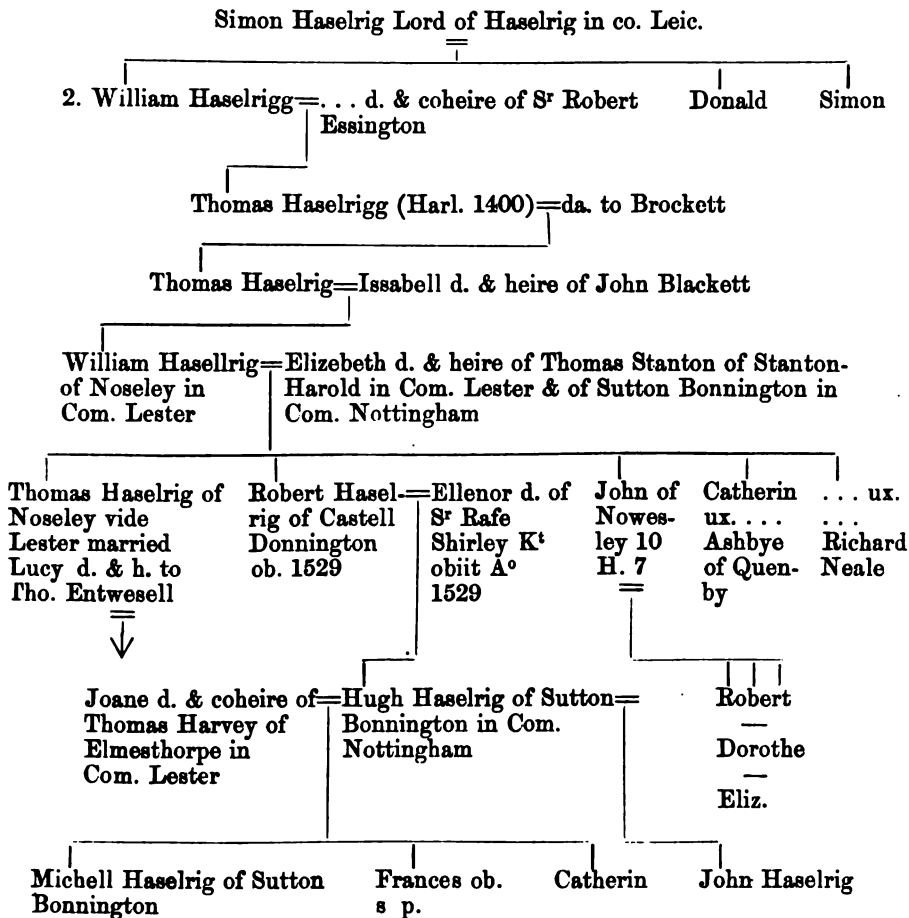

## Therland.

**ARMS.\*** *Quarterly*:—1. *Ermine, on a chief indented gules three taus argent.* 2. *Or, three bendlets azure.* 3. 1 and 4. *Gules, a cross patonce or.* 2 and 3. *Or, a saltire engrailed sable.* 4. *Vair, a fess or.* 5. *Gules, a fess indented ermine between three lions rampant or.* 6. *Azure, three eaglets displayed or.* 7. *Gules, ten bezants, a canton ermine.* 8. *Barry nebulé of six or and sable.* 9. *Or, a tower azure.* 10. *Gules, three bars or, a bordure azure charged with eight martlets of the second.* 11. *Or, on two bars gules three water bougets argent.* 12. *Gules, three birds or.* 13. *Azure, a fess or.*

**CREST.** *A demi-Capuchin friar proper.*

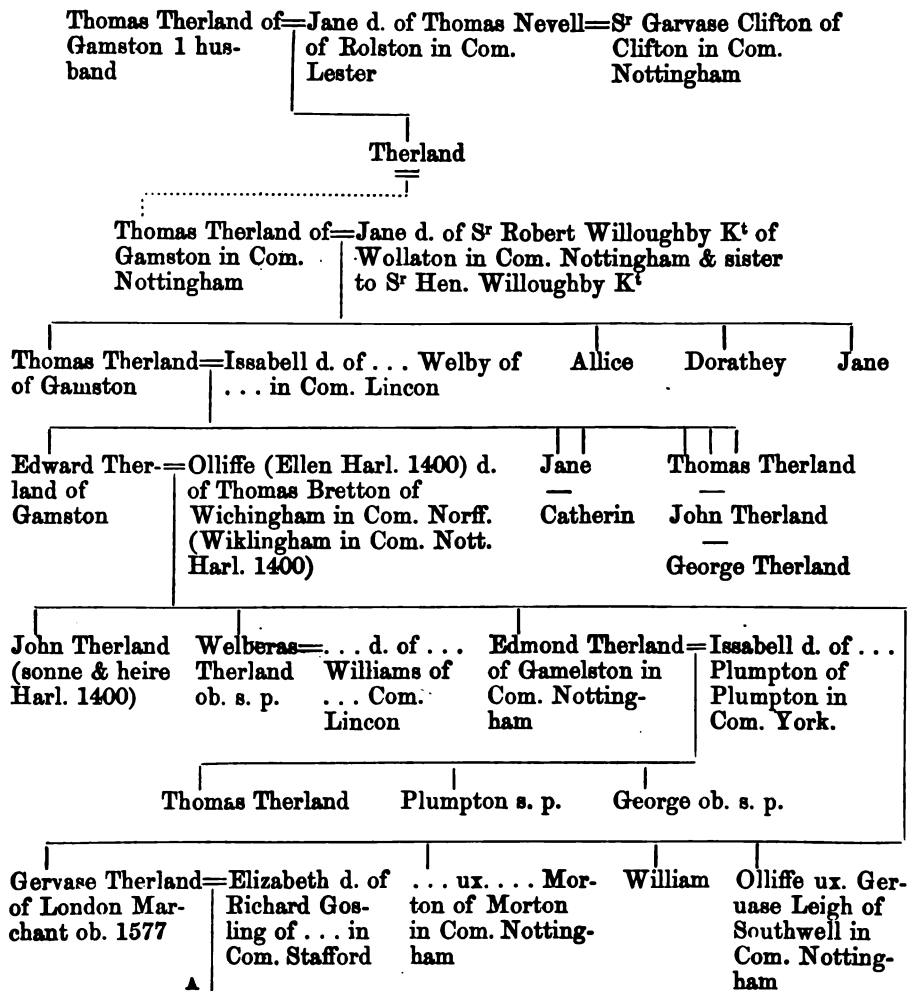

\* These quartered Coates with the crest are thus set out in the Vissitation of Surrey made in An<sup>o</sup> 1623 for Edward Thurland of Rigate in Com. Surrey.



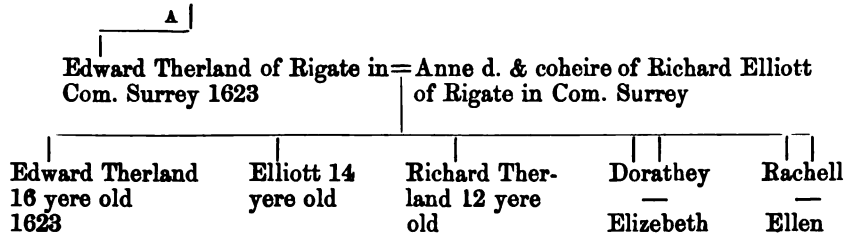

## Bingley.

**ARMS.** *Argent, two bars sable, on a canton of the last a pheon of the field, a crescent for difference.*

**CREST.** *A pellet charged with a pheon argent between two wings conjoined or.*

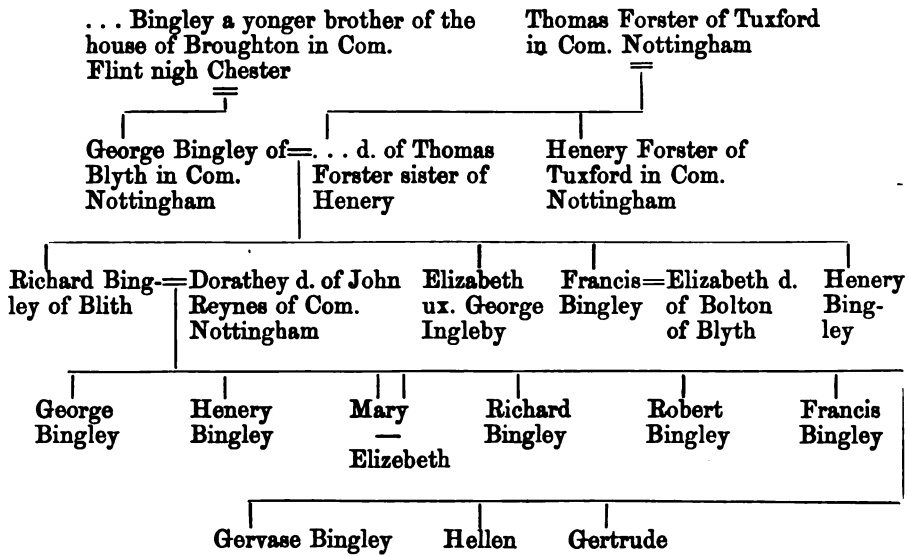

## Symcock.

ARMS. *Ermine, three bears' (?) heads sable muzzled or.*  
 CREST. *A beaver passant ermine.*

Per Clarenceux Cooke 1576

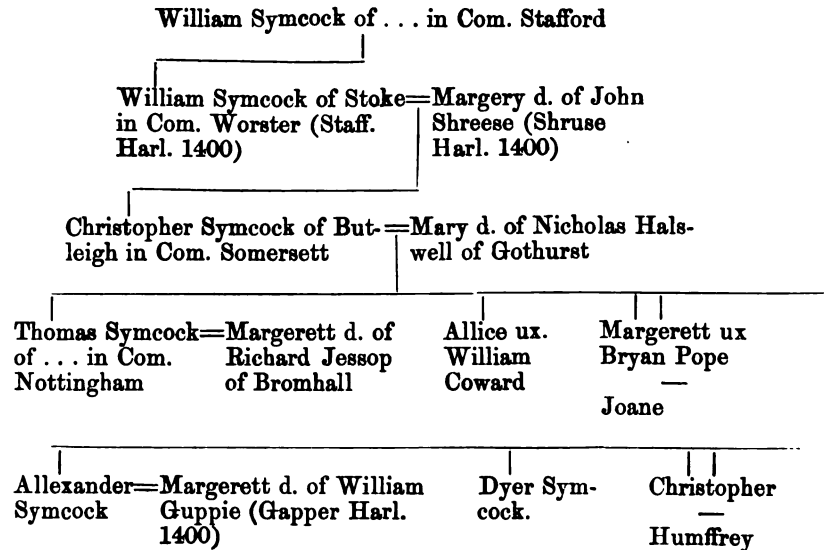

## Handley.

ARMS. *Argent, a fess gules between three goats courant sable armed and unguled or.*  
 CREST. *A goat as in the arms.*

P' William Segar Garter King of Armes A° 21 June 1612

A part of the pettegree or descent of the Famyley of Handley of Nottinghamshire being lineally descended from Handley of Yorkshire which is descended from the Aunciant Family of Handley of Handley in the county of Somerset justified by my hand at the bottom of the pettegree the 21 of June 1612.  
 This was copied by the originall.

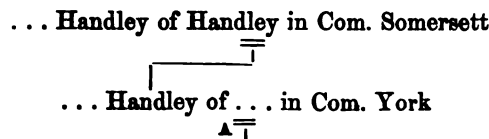

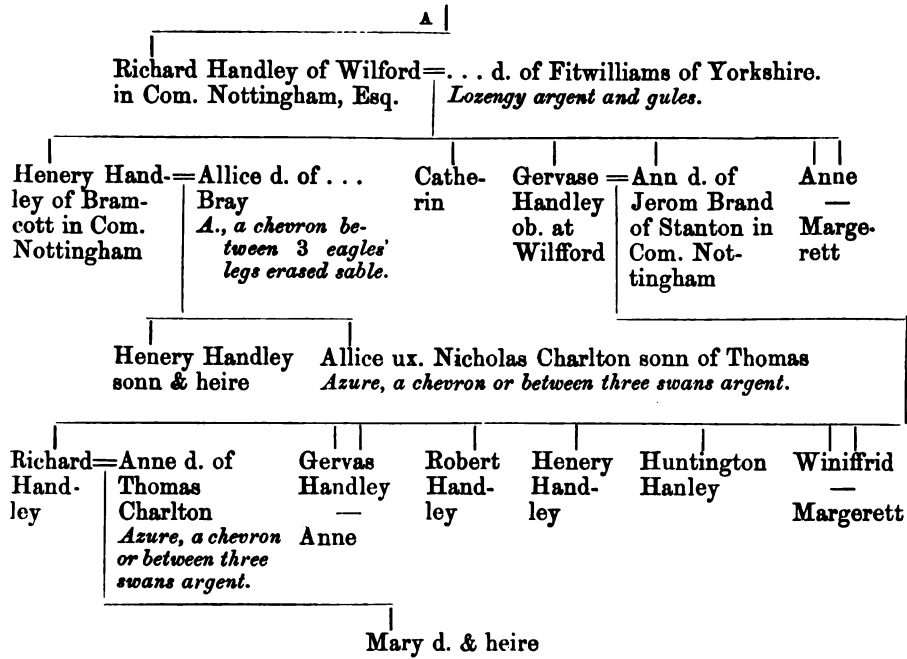

### Blondeston.

ARMS. *Quarterly:—1. Argent, six crosslets fitchée sable, a chief vair. BLONDESTON. 2. Argent, a chevron between three crescents gules. MAXEY. 3. Gules, a chevron between three cinquefoils or. CHAMBER. 4. Ermine, a fess chequé or and azure. ARDEN.*

CREST. *A wolf passant argent.*

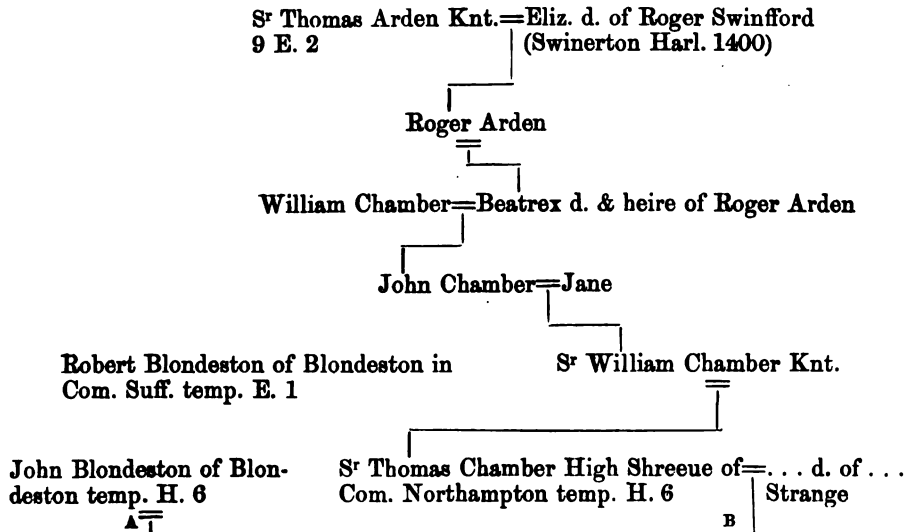

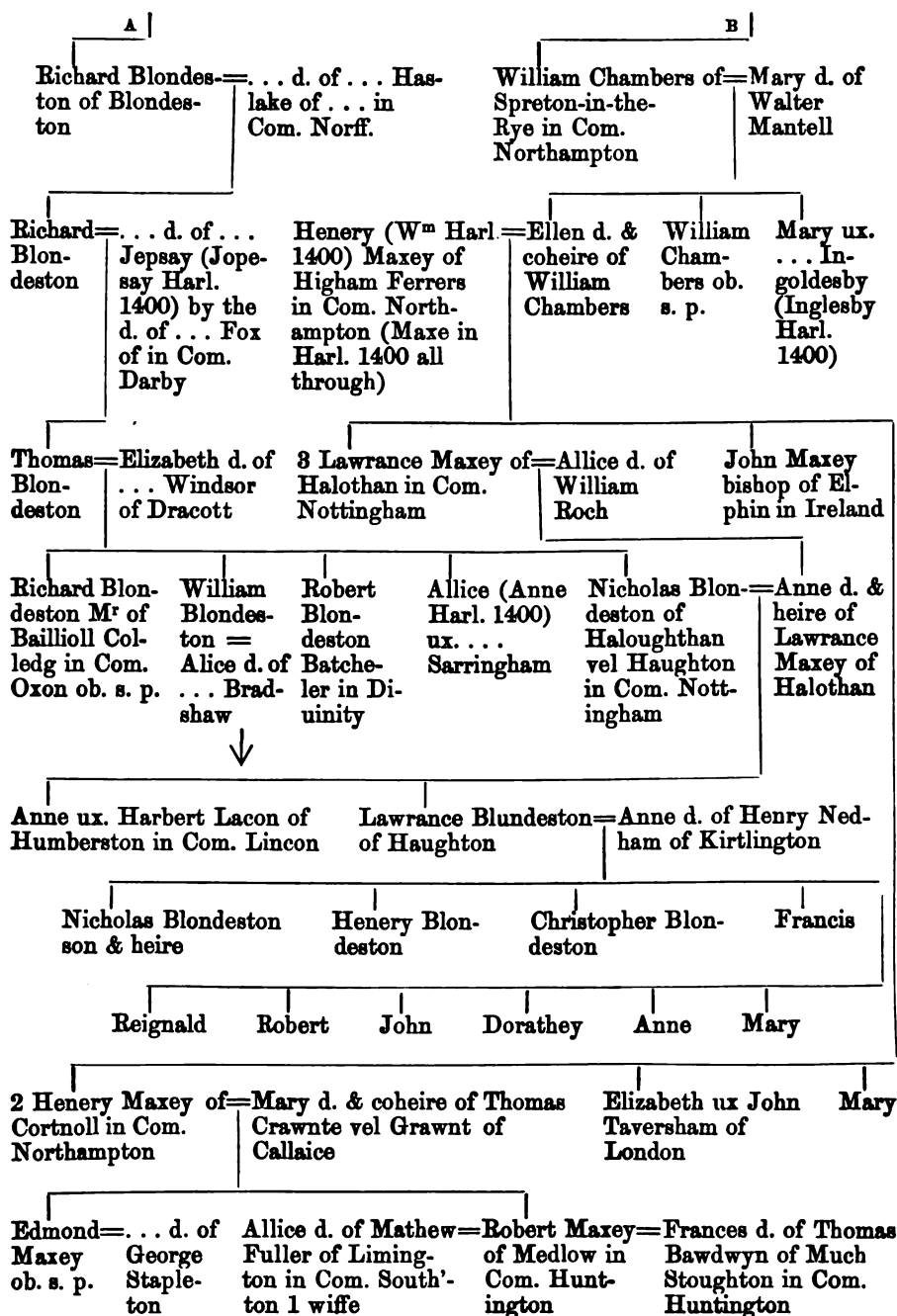

## Sturdivant.

ARMS. *Gules, a lion rampant argent, a bordure of the last charged with eight pheons sable.*

William Sturdivant of Norwell in Com. Nottingham = Beatrix d. of Rotheram of . . . in Com. Darby by the d. of . . . Linacre of Plunley

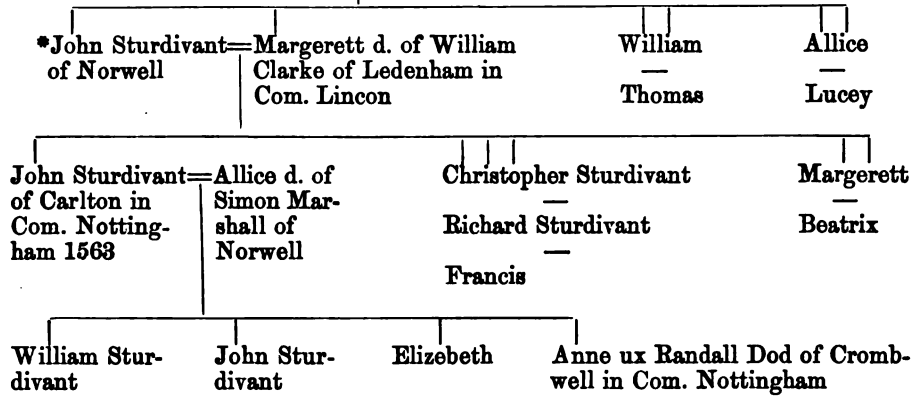

## Parkins.

ARMS. *Quarterly :—1 and 4. Or a fess dancettée ermine between ten billets ermines. 2 and 3. Argent an eagle displayed sable, on a canton or a fess dancettée between ten billets ermines.*

CREST. *A pine apple argent leaved vert.*

ALSO THIS COAT.—*Quarterly 1. Or, a fess dancettée between ten billets ermines. 2. Vert, three passion nails argent, a fleur-de-lis or for difference. 3. Argent, on a fess between three annulets sable as many mullets of the field. 4. Pale wavy of six or and gules. 5. Azure, three fans or. 6. Or, two chevrons and a canton gules. 7. Argent, a chief indented gules three annulets counterchanged. 8. Sable, three lions passant in bend between two barrulets engrailed argent. 9. Barry of eight or and gules, a mullet for difference. 10. Gules, a lion rampant or. 11. Argent, on a chief azure two saltires or. 12. Azure, three garbs or. 13. Azure, a wolf's head erased argent. 14. Chequé or and azure. 15. Gules, a bend fusilly or. 16. Or, five chevronels gules. 17. Gules, three lions passant argent. 18. Sable, three garbs argent. 19. Azure, semée of fleurs-de-lis or, a bordure gules charged with ten lioncels passant or. 20. Sable, a fret or.*

Richard Parkins of Bunney in Com. Nottingham = Elizebeth widow of Humfrey Barley of Stoke & d. of Adam Beresford of Bentley in Com. Darby

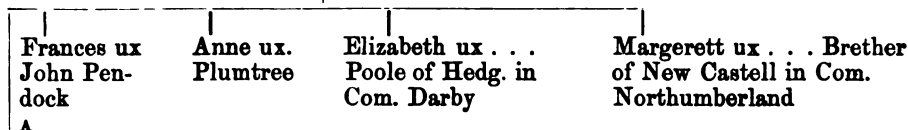

\* Harl. 1400 gives a second John in this and the next generation.

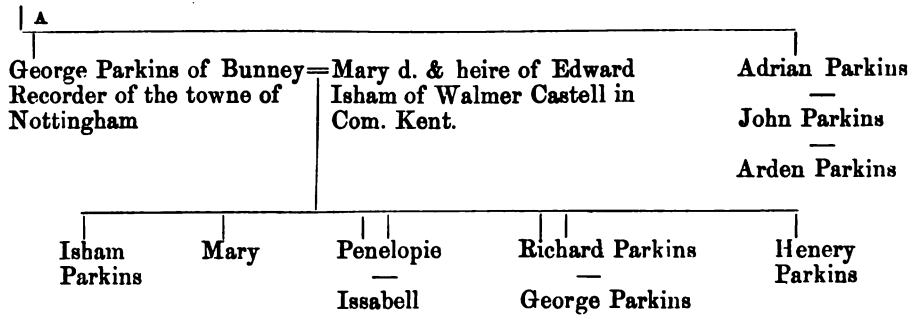

### Donham.

ARMS. *Quarterly*:—1 and 6. *Azure, on a chief indented or, a label gules.* DONHAM. 2. *Sable, three bucks' heads caboshed argent.* BOWETT. 3. *Gules ten bezants, a canton ermine.* ZOUCHE. 4. *Argent, on a fess indented sable three bezants.* BURGH. 5. *Sable, fretty or.* BELLAQUA.

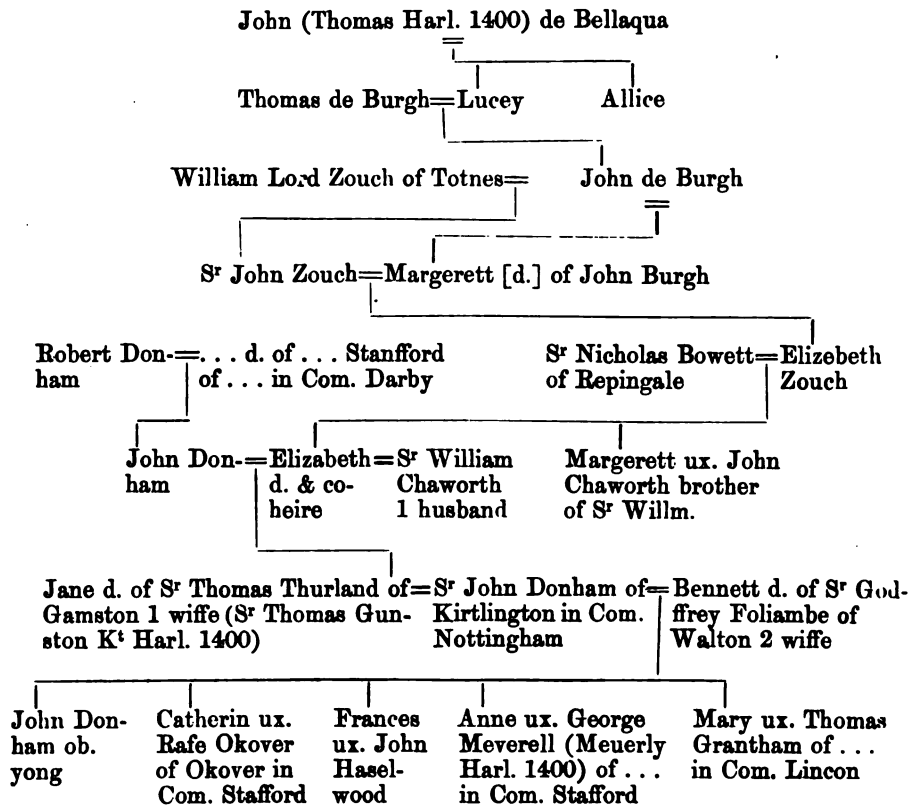

## Cornwallis.

ARMS.\* *Quarterly*.—1. *Sable, gutté argent, on a fess of the last three cornish choughs proper.* CORNWALLIS. 2. *Sable, three bars-gemelles and a canton argent.* BUCTON OF BROME. 3. *Gules, a crescent between three mullets argent.* HANSARD. 4. *Gules, a cross patonce argent, in dexter chief an escallop or.* DE LA MORE. 5. *Sable, a cross patonce or.* BRAHAM. 6. *Argent, a bend between six cross crosslets fiché sable.* TEYE. 7. *Argent, two chevrons azure, a border engrailed gules.* TIRRELL. 8. *Azure, a chevron between three ostrichs argent.* STAUNFORD.

CREST. *A stag lodged regardant argent, attired and unguled or, collared with a garland of acorns and vulned in the shoulder proper.*

Thomas Cornwallis= of London Mar- chant An <sup>o</sup> 2 R. 2	Jane d. & heire of Wm. Hansard widdow of Henery Fanner	Robert Buckton=... d. of of Brome in Com. Suffolk (Tye Harl. 1400)
--	--	--

John Cornwallis=Phillip d. & coheire of Robert Buckton of Brome

Thomas Cornwallis of=Brome in Com. Suff. =Phillip d. & coheire of Edward Tirrell of Downham in Com. Essex

John ob. s. p.	Thomas ob. s. p.	Robert ob. s. p.	William Cornwallis of Brome	=Elizebeth d. & coheire of John Staunford	Mary ux. ... Clovell of Essex	Catherin ux. Thomas Froxmer of ... in Com. Worster
----------------	------------------	------------------	-----------------------------	---	-------------------------------	--

S <sup>r</sup> John Cornwallis of Brome Knt.	=Mary d. of Edward Sulliard of Ottes in Com. Essex	Thomas Cornwallis Archdecon of Norfolk	Elizebeth ... ux. Singleton	Afra ux S <sup>r</sup> Arther Archer of Otterden in Kent
--	--	--	-----------------------------	--

Dorathey ux. John Hed. of Kent	Edward Cornwallis	Catherin a nun at Elstow	Prudence ux. ... Roydon	Edith ux. ... Barwick
--------------------------------	-------------------	--------------------------	-------------------------	-----------------------

Thomas Cornwallis =Catherin d. of Thomas Earle of Southampton

S <sup>r</sup> Thomas Cornwallis of Brome Knt. one of the Priuy Counsell to Q. Mary	=Anne d. of John Jernegan of Somerleyton in Com. Suff.	Henry Cornwallis mar'd to Caldibut	=d. and h. to Rockwood 2 wife	Richard Cornwallis of Arowton in Com. Suff.	=Margerett d. & sole heire of Lionell Lowth of Sawtrey in Com. Lincon	William Cornwallis
---	--	------------------------------------	-------------------------------	---	---	--------------------

\* For the junior branch to which Thomas Cornwallis of Okenhill Hall belonged 2 more quarterings are given in Harl. 1400. Viz' Argent, two bars and in chief a lion passant gules, and Argent, on a fess sable three mullets or pierced gules.

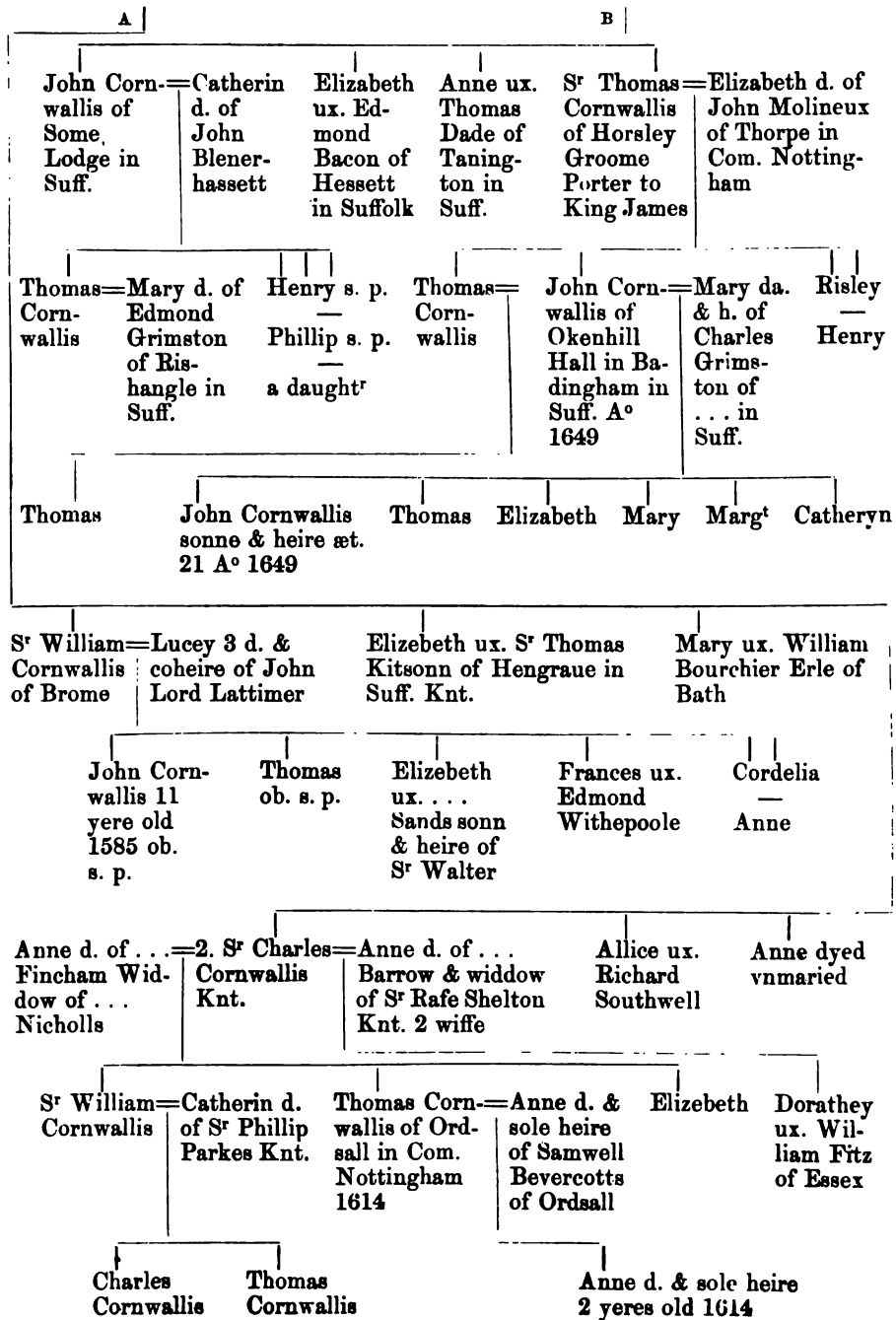



## Sacheverell.

ARMS. Quarterly 1 and 4. Argent, on a saltire azure five water bougets or, a chief gules. 2 and 3. Argent, a chevron between three birds sable beaked and legged or.  
 CREST. On a lure azure, charged with a water bouget or, having the top or fretted gules and the cords likewise or, a falcon argent beaked and belled or.

MOTTO.—"EN BONNE FOY."

Sr Patrick (Petter Harl. 1400) Sacheverell of Hopwell in com. Darby temp E. 1

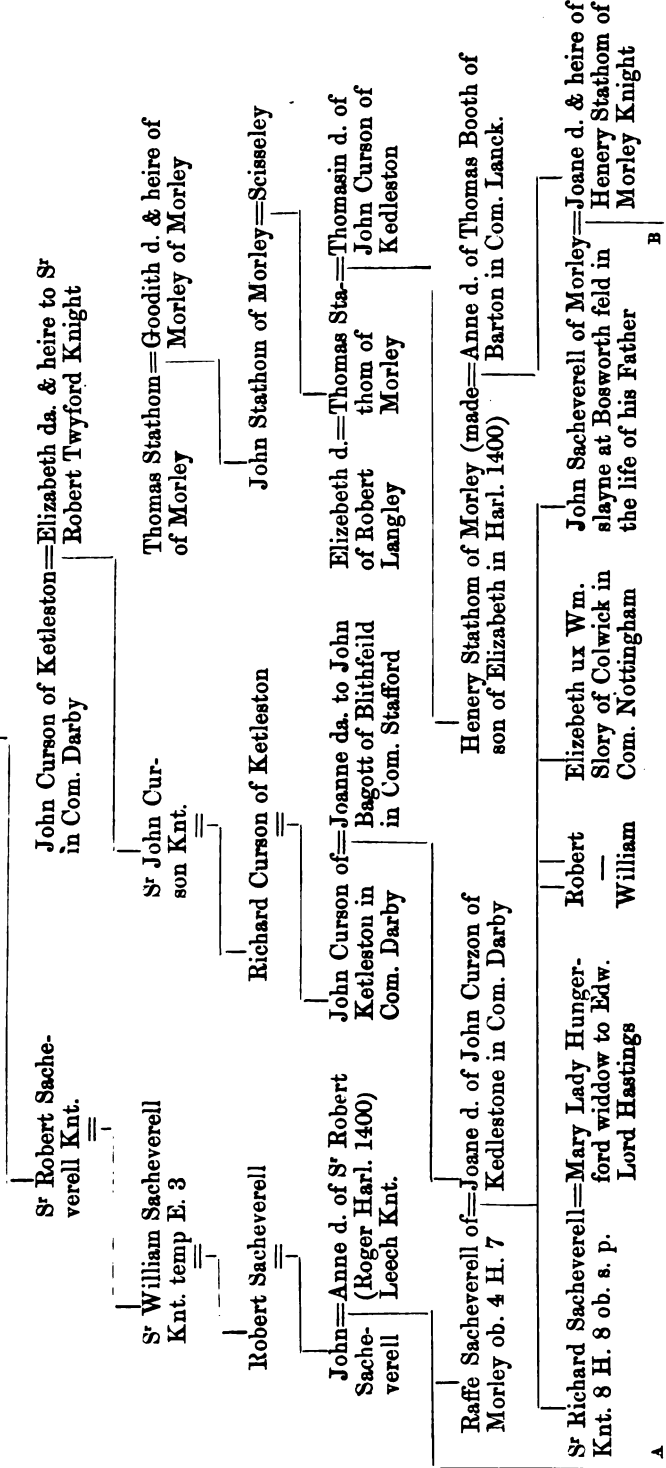

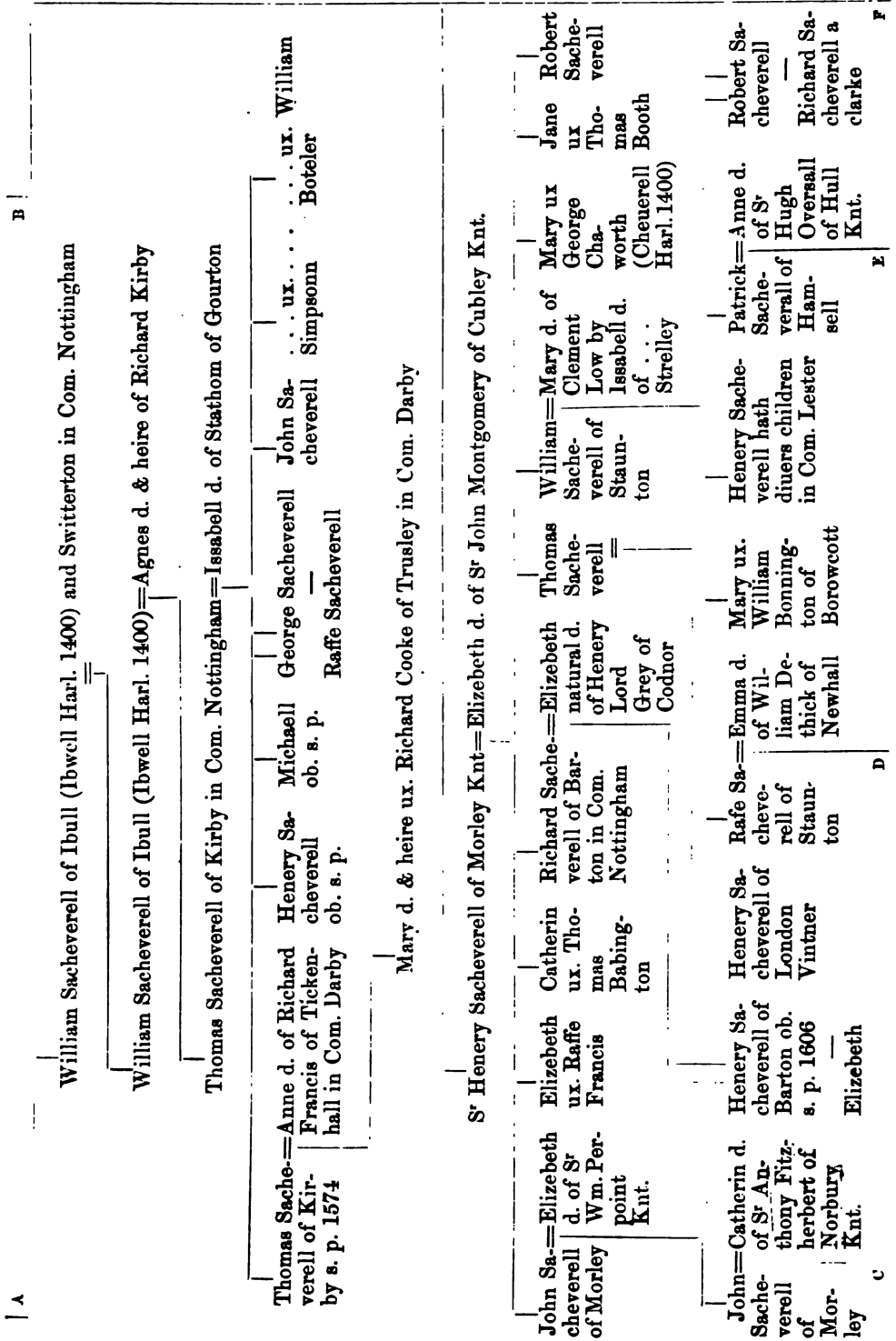

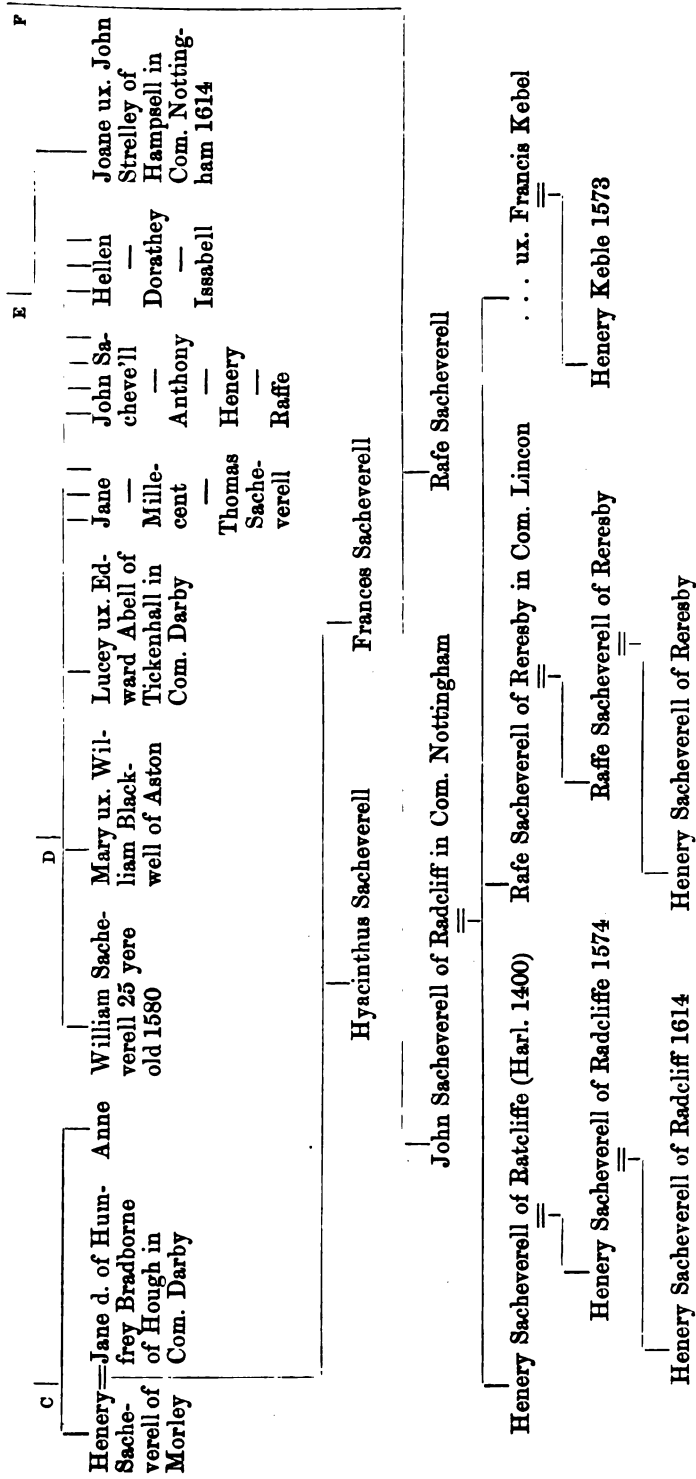

## Marshall.

**ARMS.** \*Quarterly:—1 and 8. *Sable, three bars argent, a canton ermine.* MARSHALL. Or, a saltire engrailed gules, a chief per fess indented of the first and second. BRUSE. 3. *Gules, semée of bezants, a lion rampant argent.* HAWKES. 4. *Ermine, a chief per pale, indented or and gules.* BROWNE. 5. *Argent, a chevron between three swords erect gules.* MUSTON. 6. *Azure, fretty argent.* CAVE. 7. *Ermine, on a bend sable three fishes' heads erased argent.* GILLIOTT.

**CREST.** *A demi-man in armour proper, holding in his dexter hand a baton, over his armour a sash azure, tied at the shoulder with a ribbon gules.*

**ARMS OF SCRIMSHIRE.** Quarterly:—1 and 4. *Gules, a lion rampant or, a bordure vair.* 2 and 3. *Azure, a chevron between three bees volant argent.*

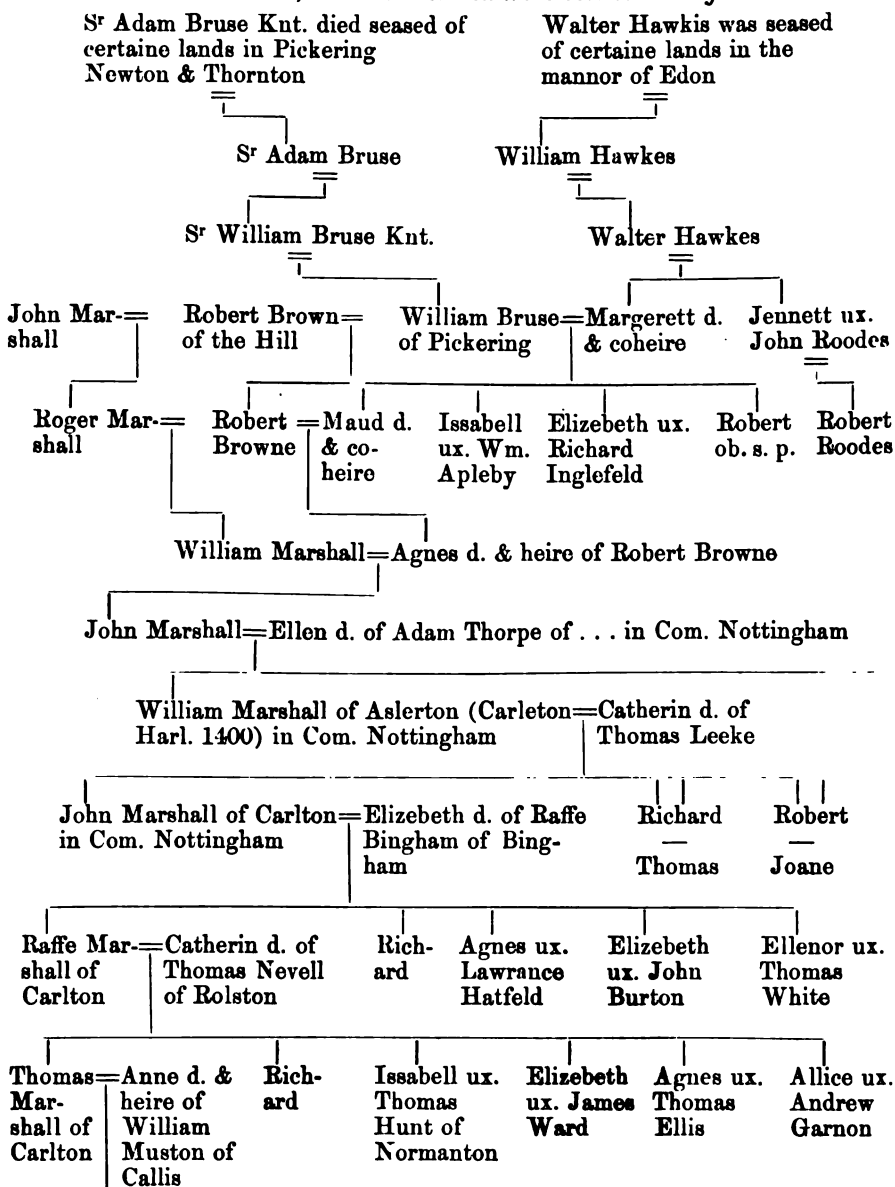

\* There is another trick of the first five quarters, with Scrimshire in a sixth.



### Digby.

ARMS. *Azure, a fleur-de-lis argent, a crescent or charged with another sable for difference.*

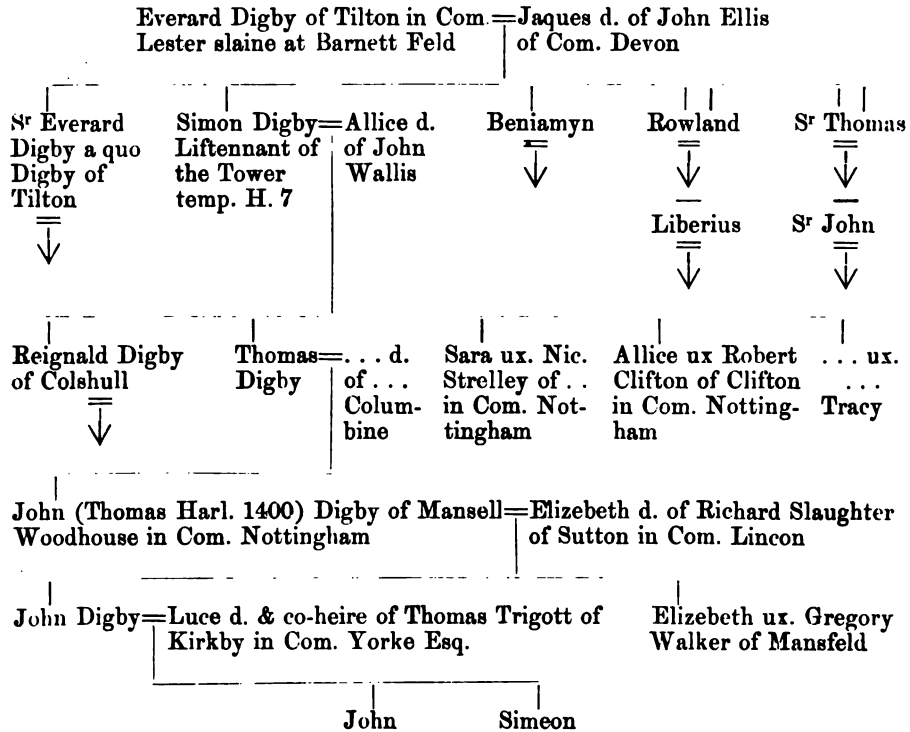

### Sandford.

ARMS. *Ermine, on a chief indented sable three boars' heads or.*

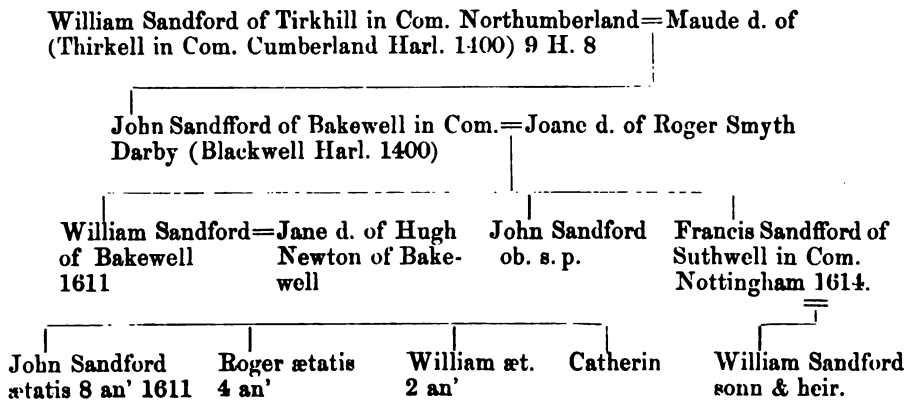

### Beresford.

ARMS. *Quarterly:—1 and 4. Argent, a bear salient sable, muzzled collared and chained or. BERESFORD. 2 and 3. Per chevron argent and sable, in chief two pheons of the last and another in base or, a crescent for difference (per chevron argent and or three pheons sable, Harl. 1400). HASSALL.*  
 CREST. *A dragon's head erased vert, pierced through the neck with a broken spear and holding the upper part of it in his mouth or, headed argent.*

Both coat and crest are differenced with a crescent.

John Beresford of Beresford in Com. Stafford

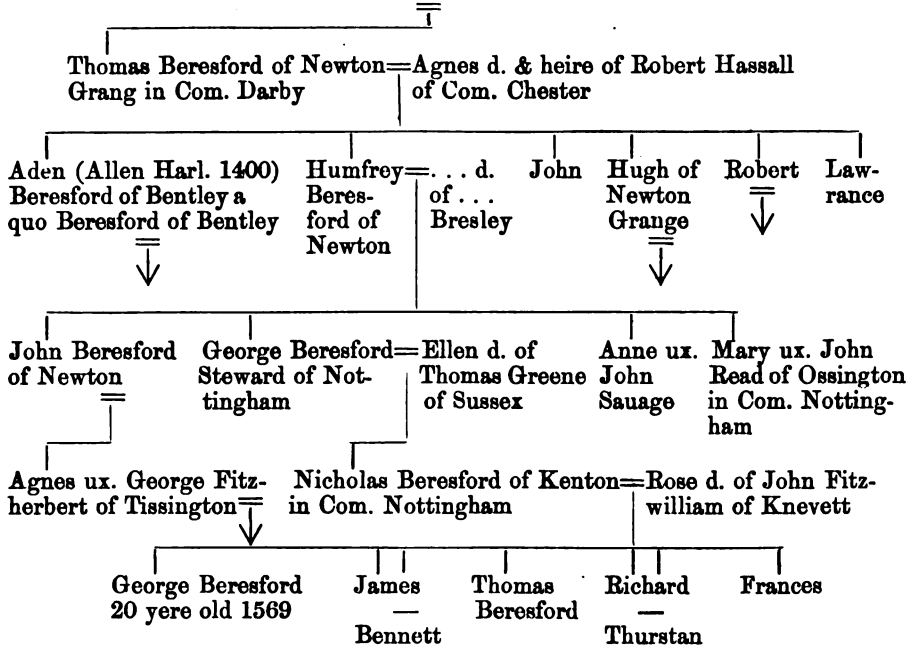

### Rolston.

ARMS. *Quarterly:—1. Argent, a cinquefoil sable, on a chief gules a lion passant guardant or, a crescent for difference. ROWLESTON. 2. Vert, on a bend argent three crosses patonce sable. WINGFELD. 3. Or, on a fess gules three water bougets argent. BINGHAM. 4. Azure, a cross engrailed or. CHARNELLS. 5. Gules, a fess ermine between two chevrons or. WOLLATON. 6. Paly of six argent and azure. STRELLEY.*  
 CREST. *An eagle's head erased proper, beaked or.*

Both coat and crest are differenced with a crescent.

James Rolston of the ley in Com. Darby=Anne d. of John Babington

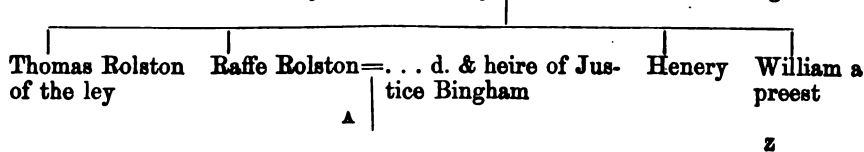

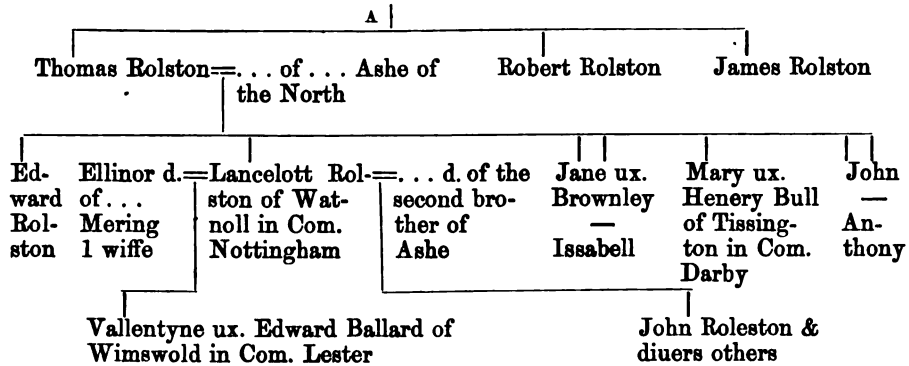

### Bassett.

Rad'us Bassett de Sapcot d'ns de Chedley dedit terras in Chedley Rad'us filio Rad'i Bassett per finem An° 56 H. 3 fuit Baro in p'liamento Ann° 49 H. 3

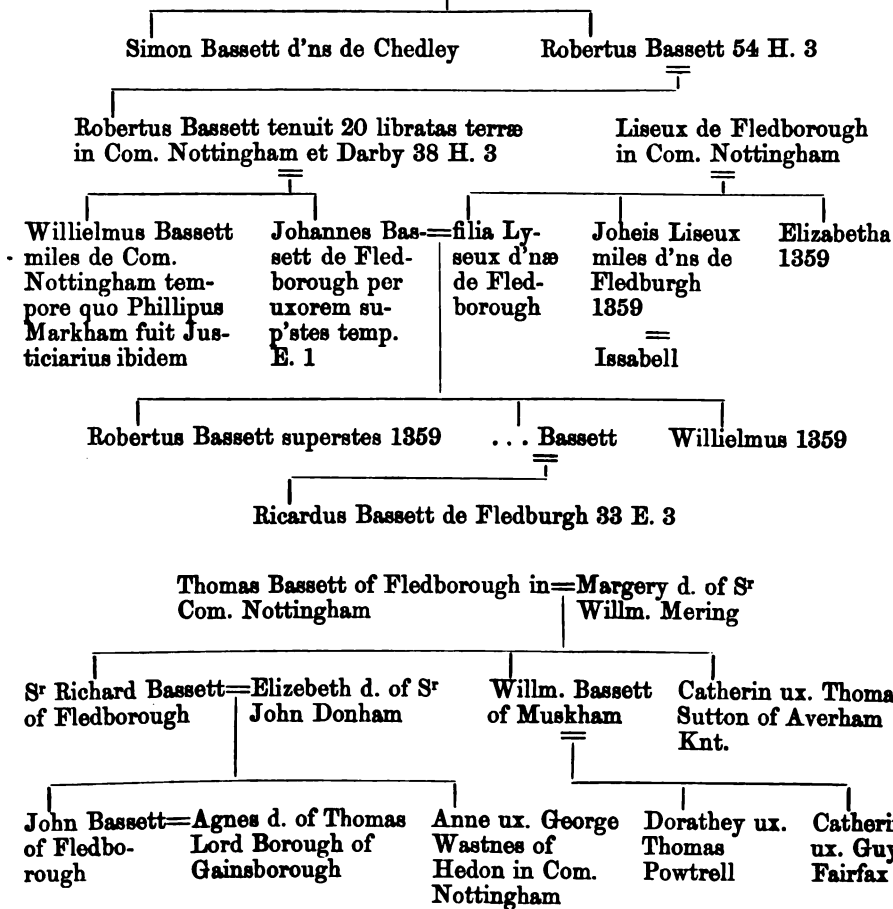



**Bevercotts.**

ARMS. *Argent, a cross patonce azure, a label gules.*

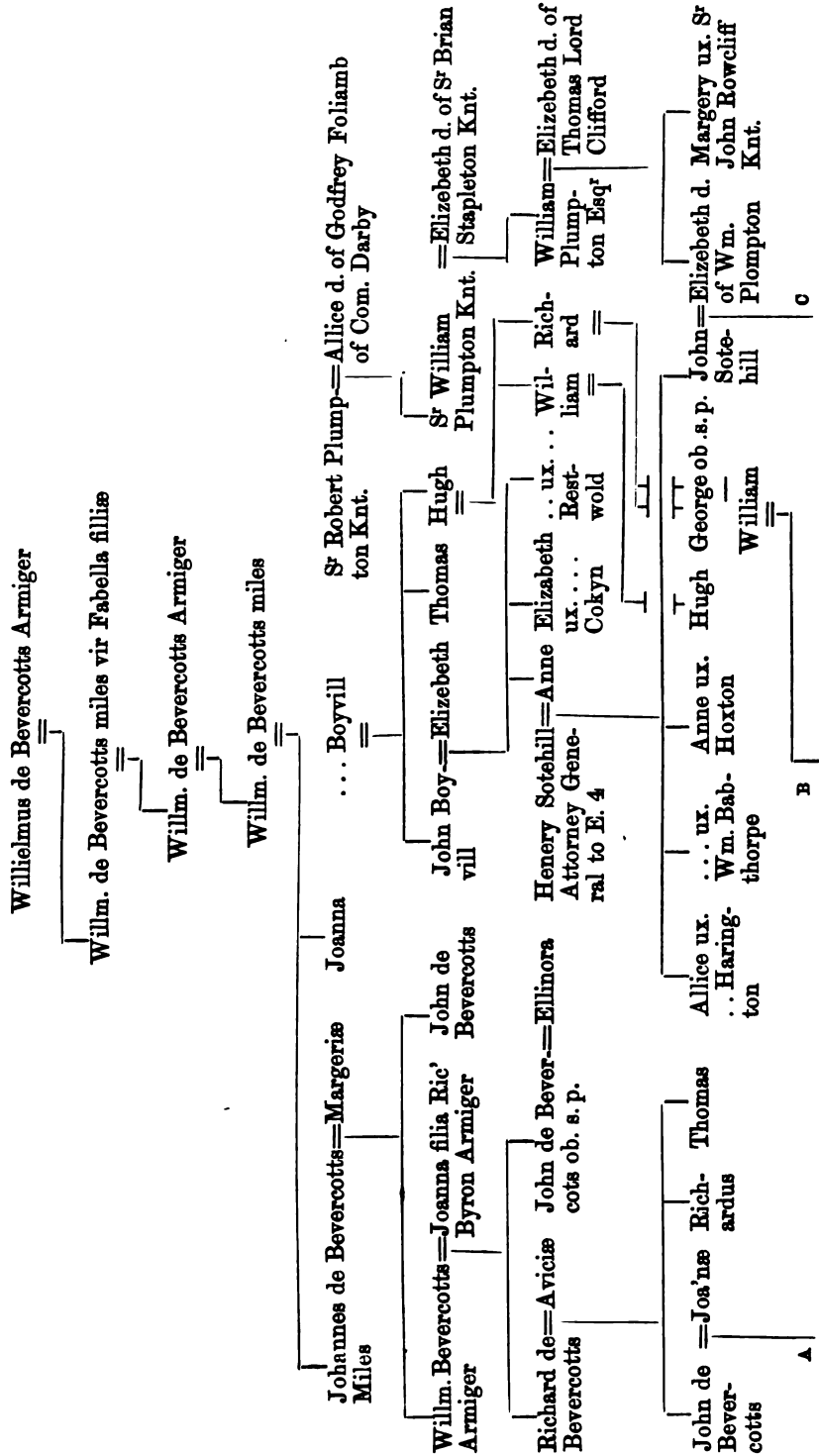

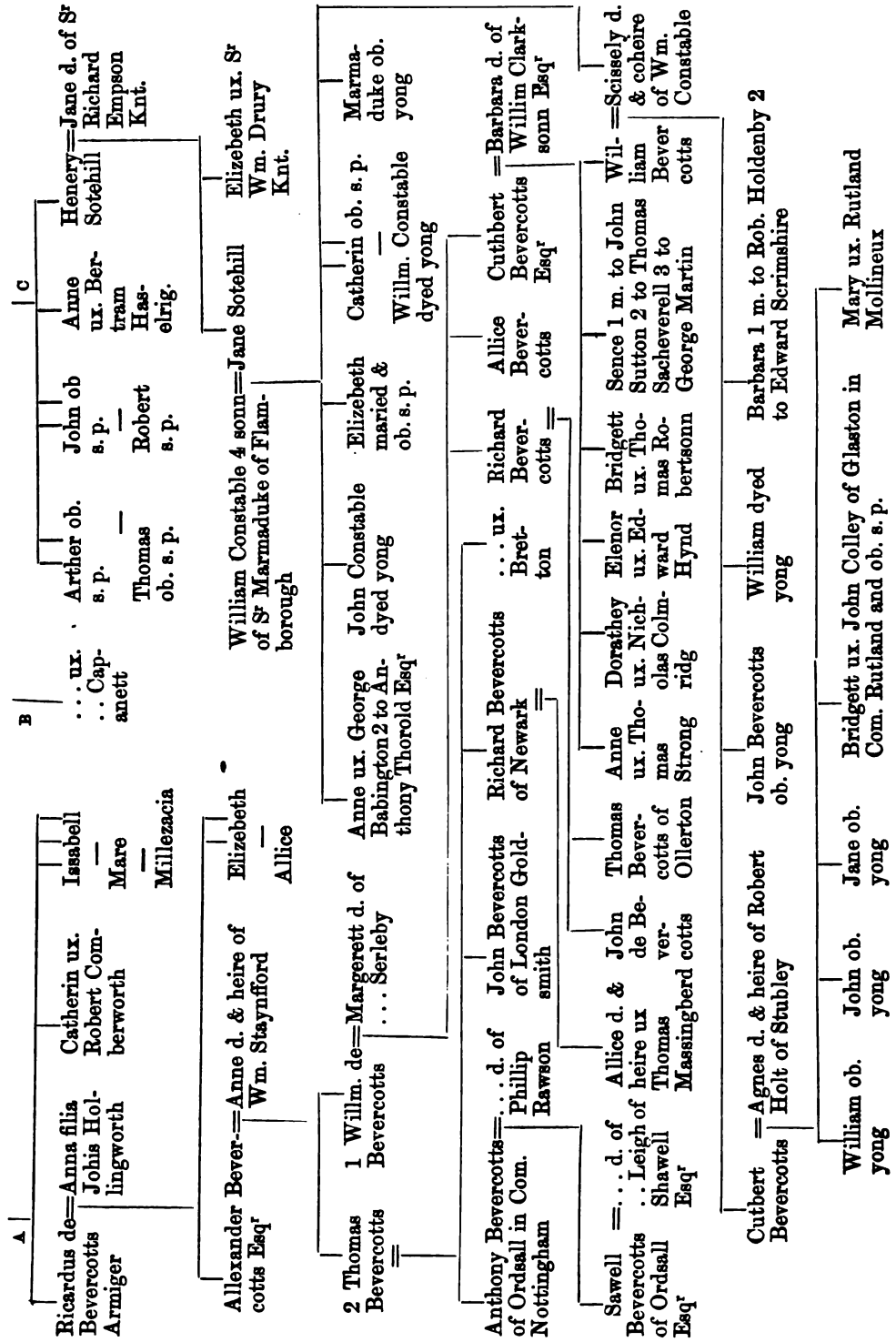

## Wase.

ARMS. *Argent, on a chevron sable between three garbs azure banded or as many estoiles of the field, in chief a mullet for difference gules.*

CREST. *An arm embowed in armour garnished or issuing out of clouds irradiated gold holding a battle axe headed argent, a mullet for difference.*

John Wase of London Marchant

John of the countie= Alice d. & heire of John= William Hill mar-  
Lester marchant of the staple Bayly of Rotherby in Com. Lester chant of Callice 1 husband

Richard Wase of= Elizebeth d. of George Meverell  
Lester temp H. 8 | of Throwley in Com. Stafford

Thomas Wase of Rotherby in= Anne d. of Thomas Coul- Anne ux William Wid-  
Com. Lester temp. Q. Mary | clough of Com. Stafford dew of Com. Stafford

Samson Wase =	Thomas= Margery Wase of d. of Wm Hickling Brookes- in Com. by of Notting- Gadesby ham	Edward — John	Anne ux. George Allen of South Croxtton in Com. Lester	Elizebeth 1 m. to Augustin Hynd 2 to Thomas Amer- sonn
---------------------	--	---------------------	--	--

Margerett ux. Henry Fox of Great Alice s. p. Jane s. p. Dorathey s. p.  
Wigston in Com. Lester

## Moyle.

ARMS. *Quarterly 1 and 4, quarterly 1. Gules, a mule passant and a bordure argent, in dexter chief a mullet or. 2. Gules, a greyhound courant or between two bars argent charged with three martlets sable, in chief as many plates. 3. Argent a saltire sable between four estoiles gules. 4. Quarterly embattled argent and sable. 2 and 3. Or a chevron between two roses in chief gules and a dolphin embowed in base azure. A crescent for difference over the whole coat.*

CREST. *Two demi dragons addorsed, their necks entwined, the dexter gules, the sinister or.*

MOTTO.—“DIEU GARDA LE MOYLE.”

Thomas Moyle= Amye d. & heire of . . . Langstone

Raffe Moyle of Bowerhall in Mole Ash in Com. Kent

Thomas Moyle= Marcye d. of . . . White

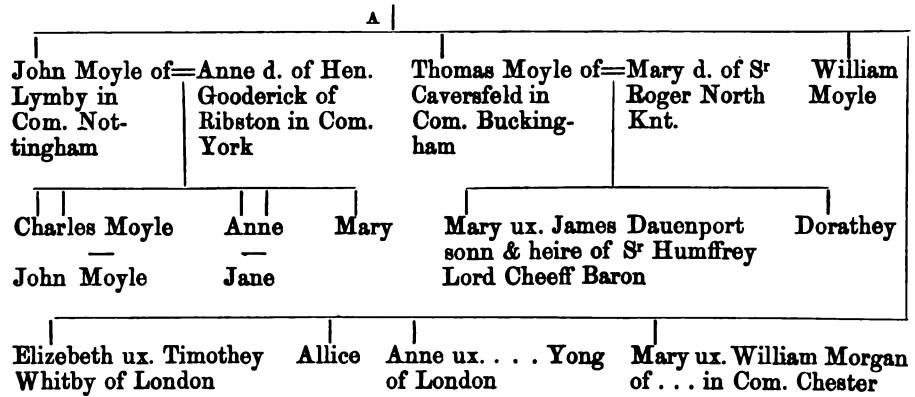

### Sabell.

S<sup>r</sup> John Savell of . . . in Com. York = Jane d. of Wm. Gascoigne of Gawthrop

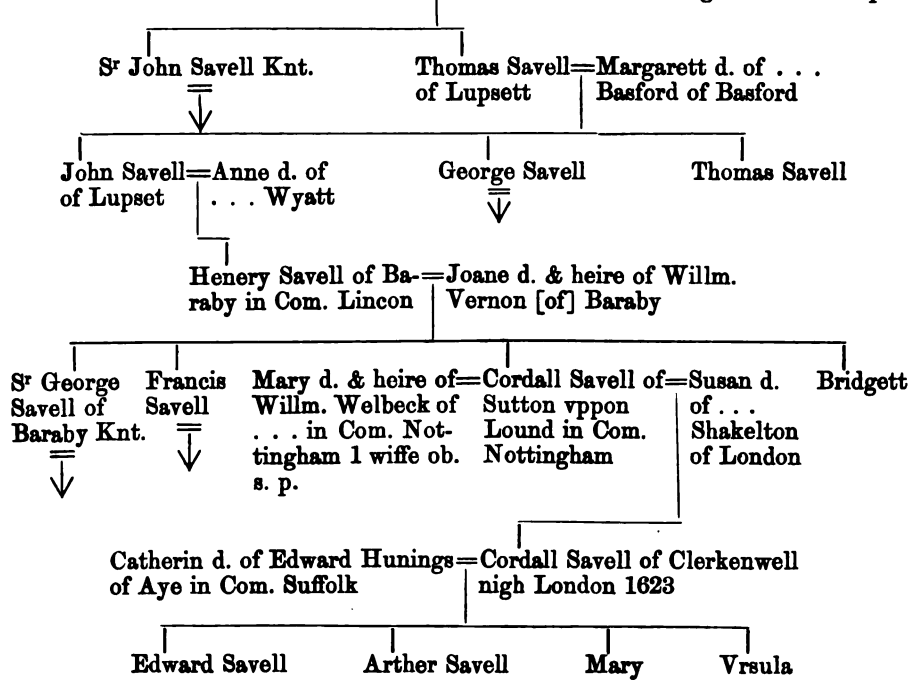

**Goodere.**

ARMS. Quarterly:—1. A fess between two chevrons vair. 2. Per fess or and argent, a lion rampant azure. 3. Gules, a wivern argent. 4. Gules, on a chevron cotised argent three lions rampant of the field. 5. Paly of six argent and gules a bordure engrailed azure, on a canton a spur. 6. Quarterly per fess indented argent and sable, in the first and fourth quarters a hunting-horn argent (sic). 7. Azure, three peacocks' heads erased argent. 8. Gules, on a fess or between three birds argent as many fleurs-de-lis azure. 9. Azure, a lion rampant or, a bordure engrailed gules, and a canton of the second. Over all a crescent for difference.

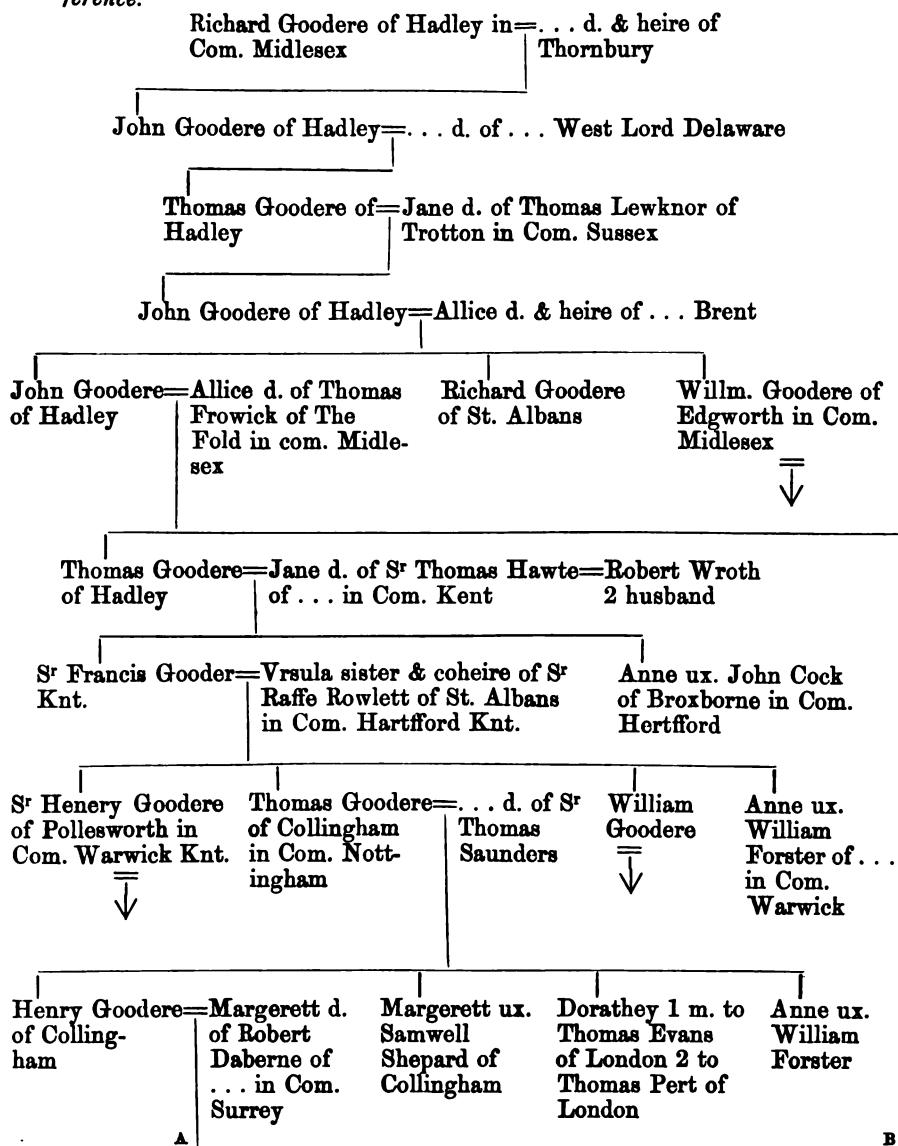

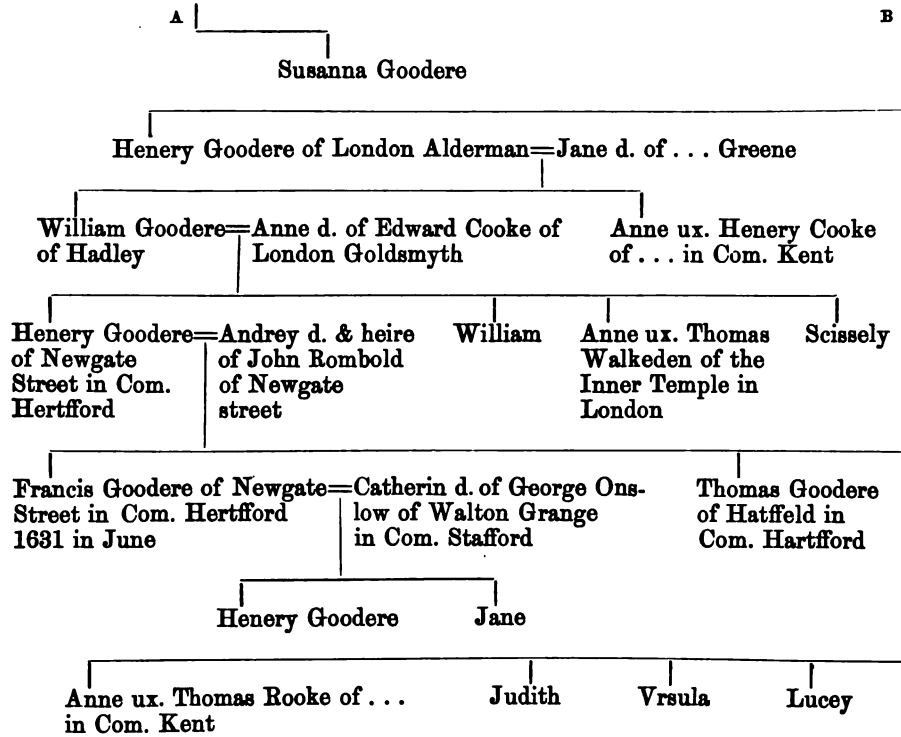

### Stockwith.

ARMS. *Or, two bars azure, on a chief of the last three cinquefoils argent.*

Thomas Stockwith of West Stockwith in Com. Nottingham

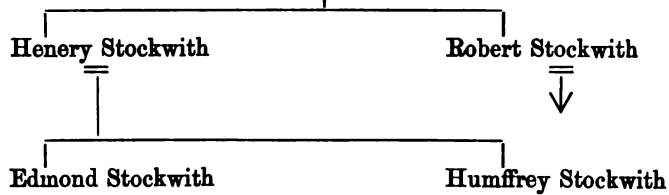

### Power.

Stephen Power of Edwalton in Com. Nottingham=. . . d. of . . . Cressey

Christopher Power of Edwalton & Wiverton=. . . d. of . . .  
in Com. Nottingham      Bookwood

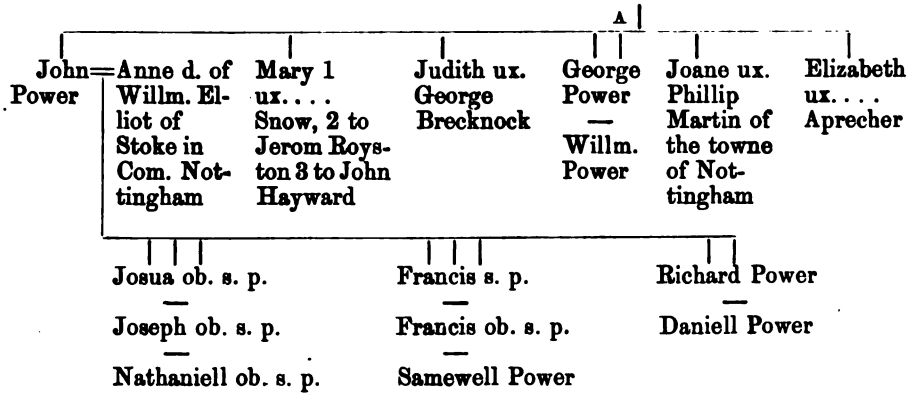

### Barnard.

**ARMS.** *Argent, on a bend azure three escallops of the field, in sinister chief a mullet sable within an annulet gules for difference.*

**CREST.** *A demi-lion rampant argent, holding in his paws a snake azure, charged on the shoulder with a mullet within an annulet for difference.*

These Armes & Crest were allowed to Abell Barnard of Pirton in Com. Oxon vnder the hand of William Camden Clarenceulx.

Thomas Barnard of Pirton in Com. Oxon docter of divinity was descended of the Barnards of Enderby in Com. York	= Edith d. of . . . Ballow of . . . in Com. Berks widdow of . . . Esmond of . . . in Com. Berks
--	---

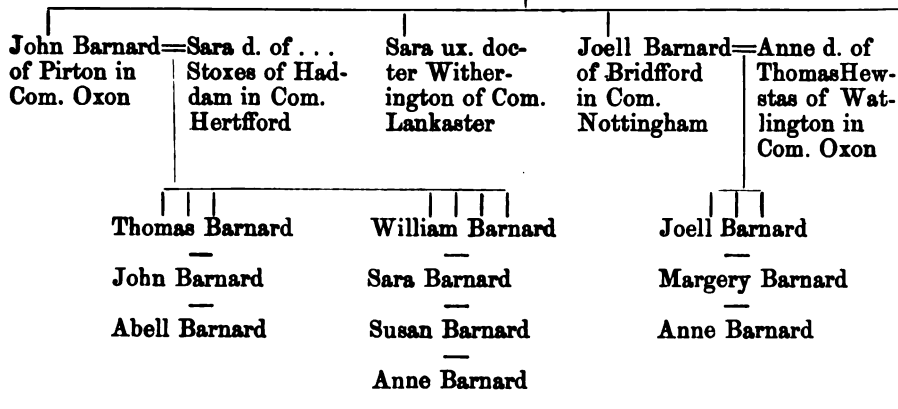

Mary ux. Clement Colomore docter of the Civill Law Chancellor of the bishoprick of Durham sonn [of] Willm. Colomore of Bremegham in Com. Warwick

**Medhop.**

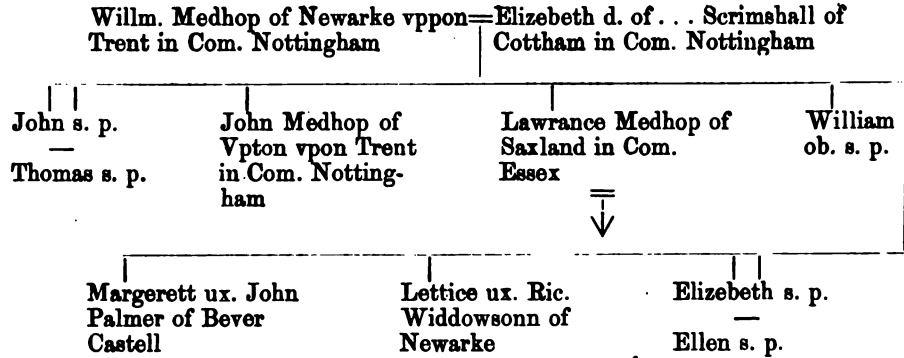

**Wightman.**

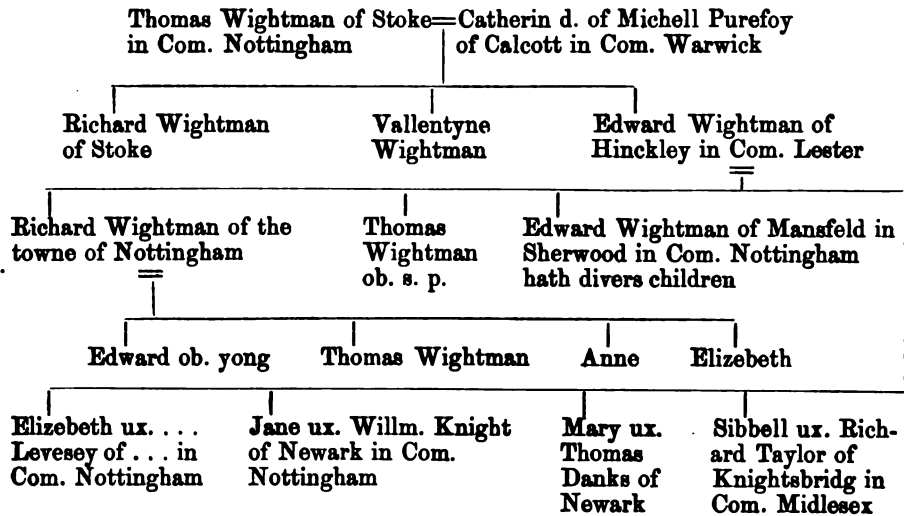



**Stanton.**

ARMS. *Quarterly*:—1. *Argent, two chevrons sable, a bordure engrailed gules.* STANTON. 2. *Argent, three bears' heads erased sable, muzzled or.* BARWICK. 3. *Argent, on a bend sable three popinjays or, collared vert, an escallop argent for difference.* CURSON. 4. *Barry of six ermine and gules.* HUSSEY.

Sr Bryan de Stanton lived in the 6 yere of Edward the Con.= . . . d. of Theobald Chawser fessor hee was Lord of Stanton in Com. Nottingham  
*Per pale ar. and gu. a bend counterchanged.*

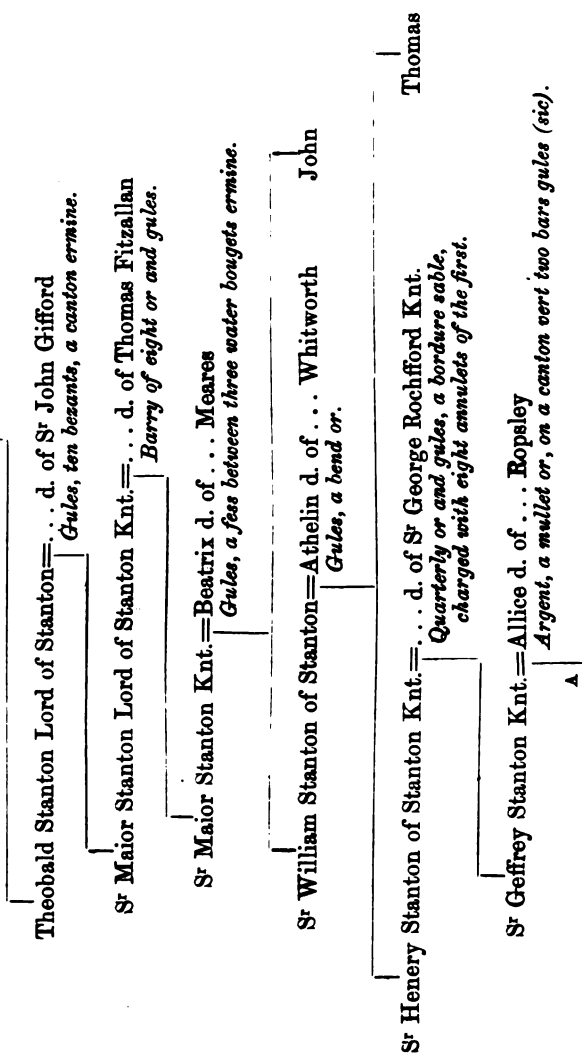

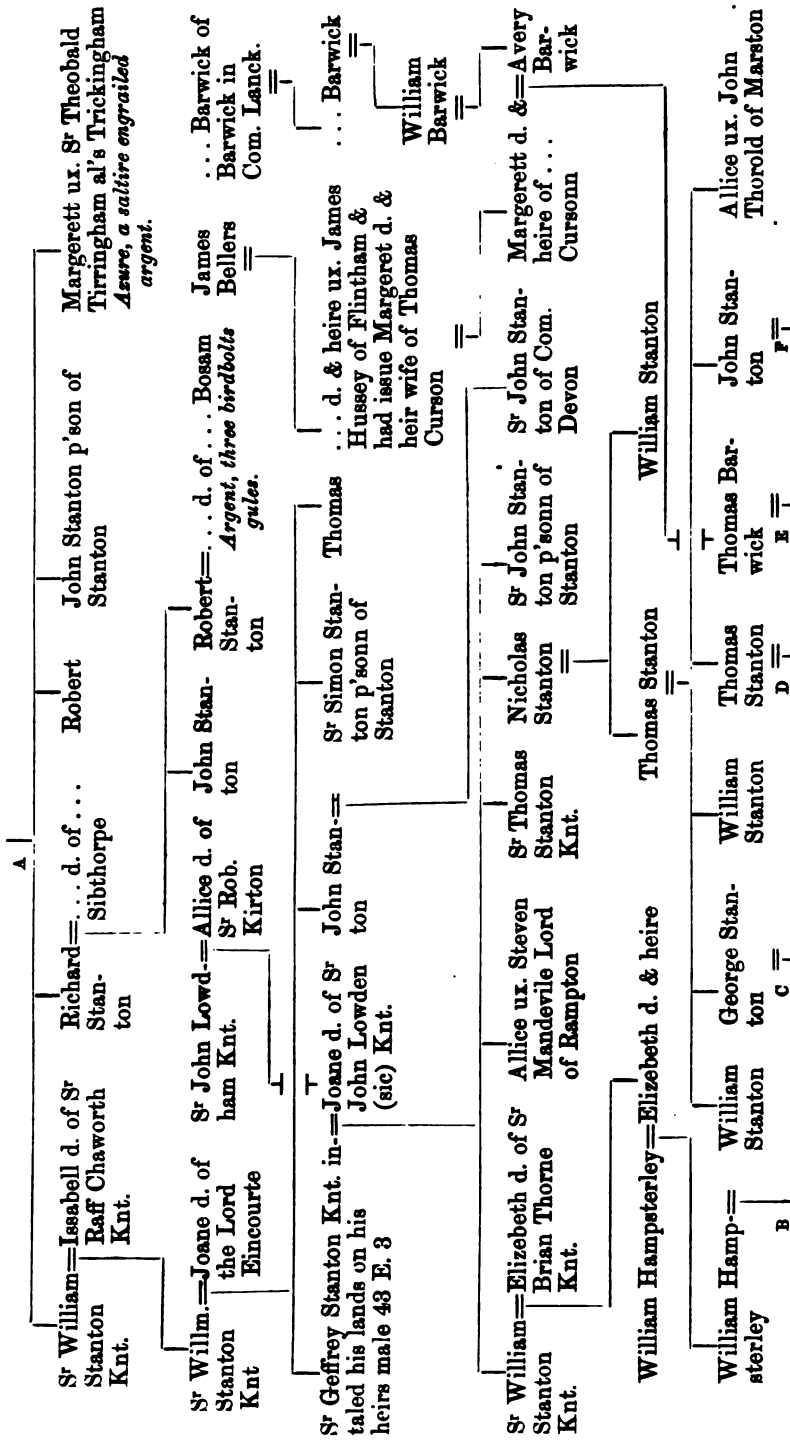

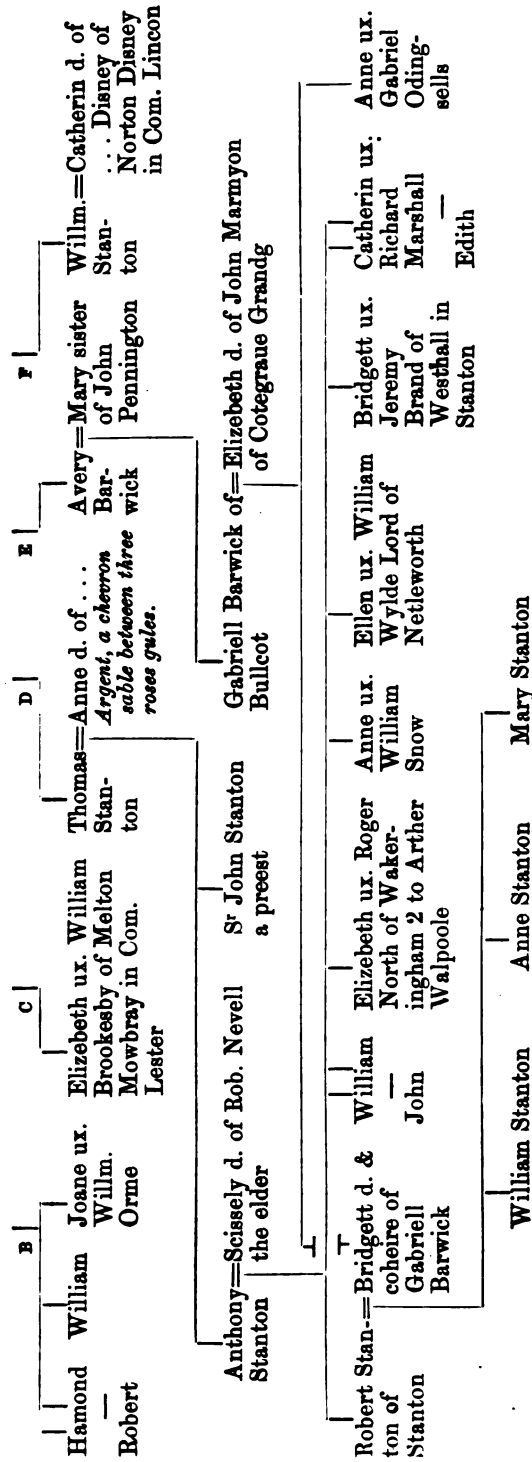

### Marshall.

John Marshall of Mustham=Anne d. of Henery Cave of Cold  
 in Com. Nottingham | Ashby in Com. Northampton

Henery Marshall

### Bland.

Sr John Nevell of Bystbrooke in Com. Nottingham

William=Jane d. & . . . d. & coheire  
 Bland | coheire ux . . . Owelys

John Bland of Goldington in Com. Nottingham

Richard Bland . . . ux . . . Tuke

Sr Bryan Tuke Knt.

### Heron.

John Heron=Margerett d. of Nicholas Ridley by  
 of . . . | Margerett d. of . . . Musgrave

William Heron of Ford Castell in  
 Northumberland yonger sonn

. . . d. of Grif=Sr John Heron Knt.=Elizbeth d. of John Roper  
 fith Reade of | Mr of the Jewell of Kent by whome ther is  
 of Wales | Howse to H. 8 yssue in Linconshire

▲

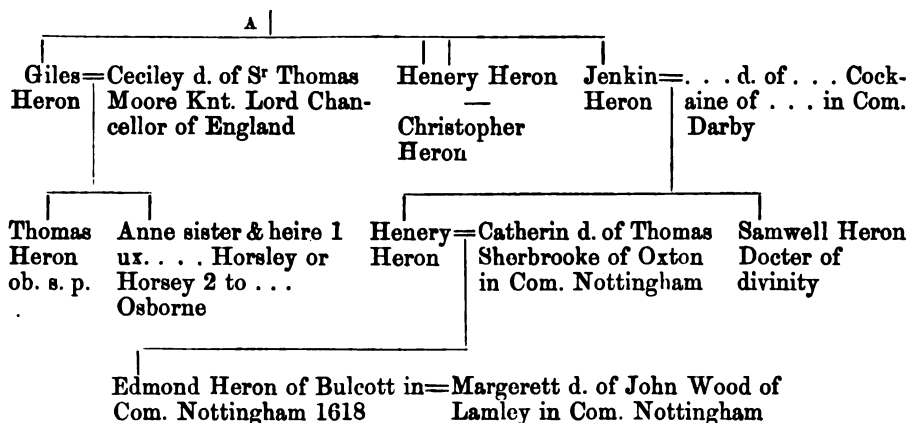

### Claxton.

ARMS. *Gules, a fess between three hedgehogs argent.*

CREST. *On a coronet or a hedgedog argent.*

Both arms and crest are charged with a crescent azure for difference.

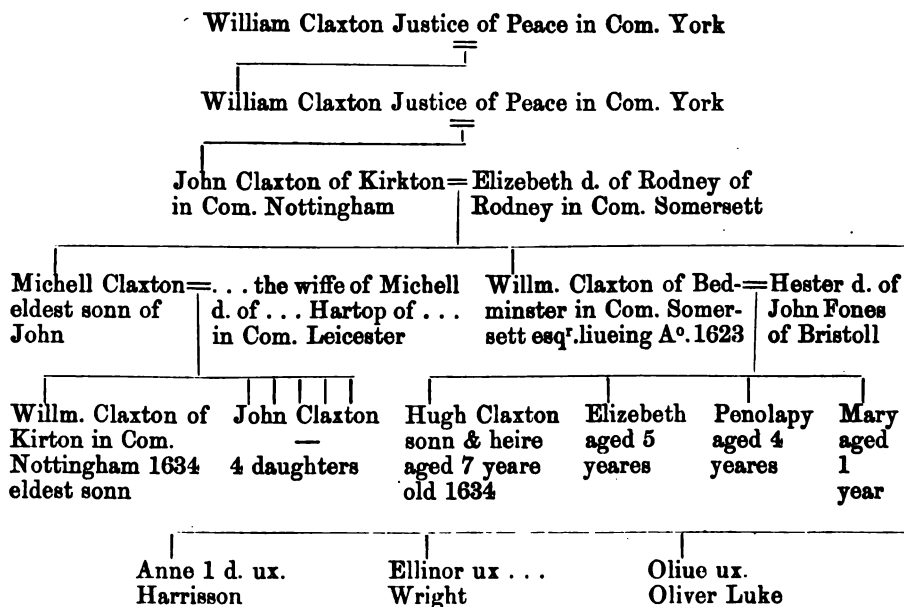

This Pettigree is vnder the hand & seale of Sr Richard St. George Knt. Clarenceulx king of Armes for William Claxton of Bedminster in Com. Somerset.

## Willoughby.

ARMS.\* *Quarterly*:—1. *Sable, a cross engrailed or.* 2. *Gules, a cross moline argent.* 3. *Gules, two lions passant argent, a label azure.* 4. *Quarterly 1 and 4. Gules, a lion rampant or.* 2 and 3. *Sable, a fret or, over all a crescent for difference.* 5. *Or, a lion rampant double queued sable.* 6. *Gules, a fess dancettée between six cross crosslets or.* 7. *Barry of six ermine and gules three crescents sable.* 8. *Gules, on a bend wavy argent three birds sable.* 9. *Argent, a fess between three boars' heads sable.* 10. *Argent, a chevron engrailed gules between three escallops sable.*

John Alphew of Bore Place in Com. Kent.

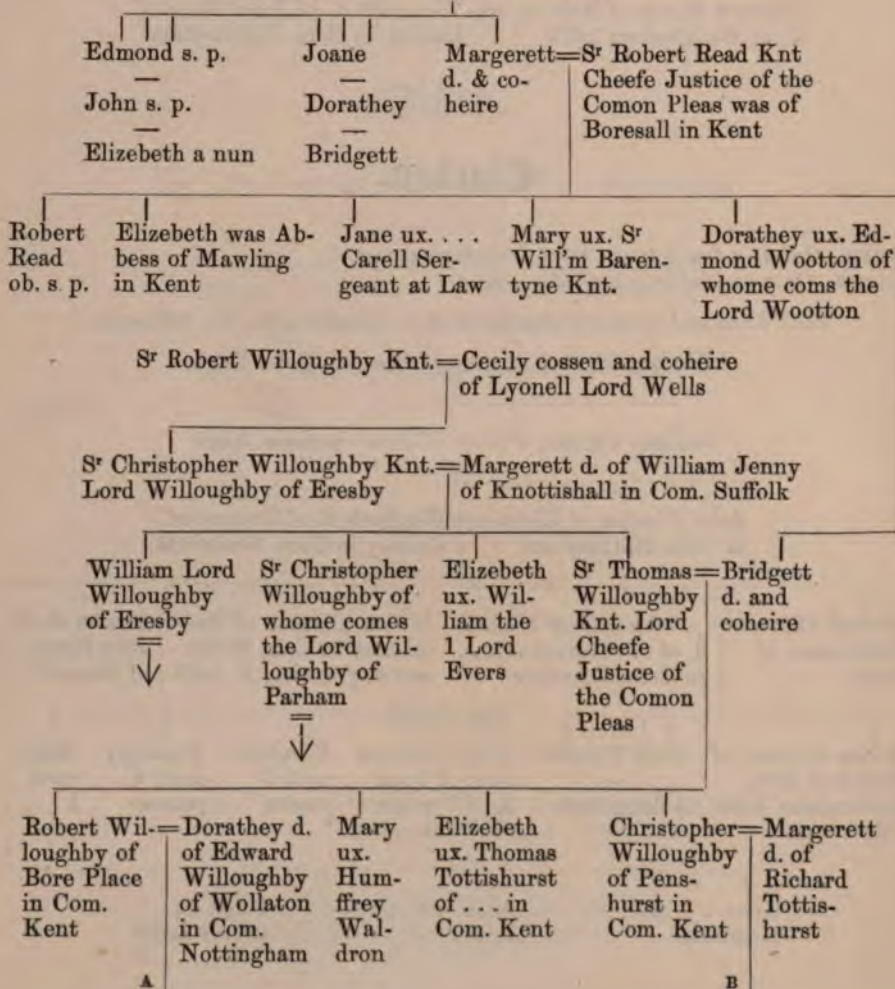

\* There is another shield tricked quartering these coats with those described at page 145, with the owl for crest as before.

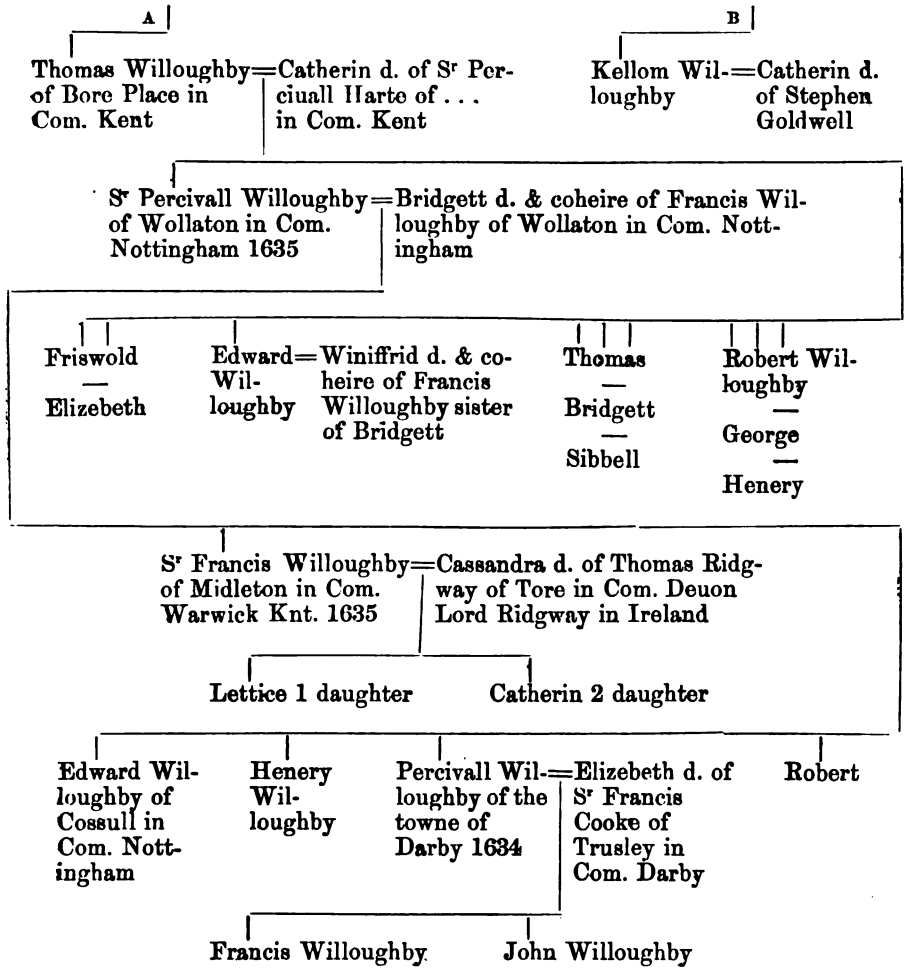

## Sutton.

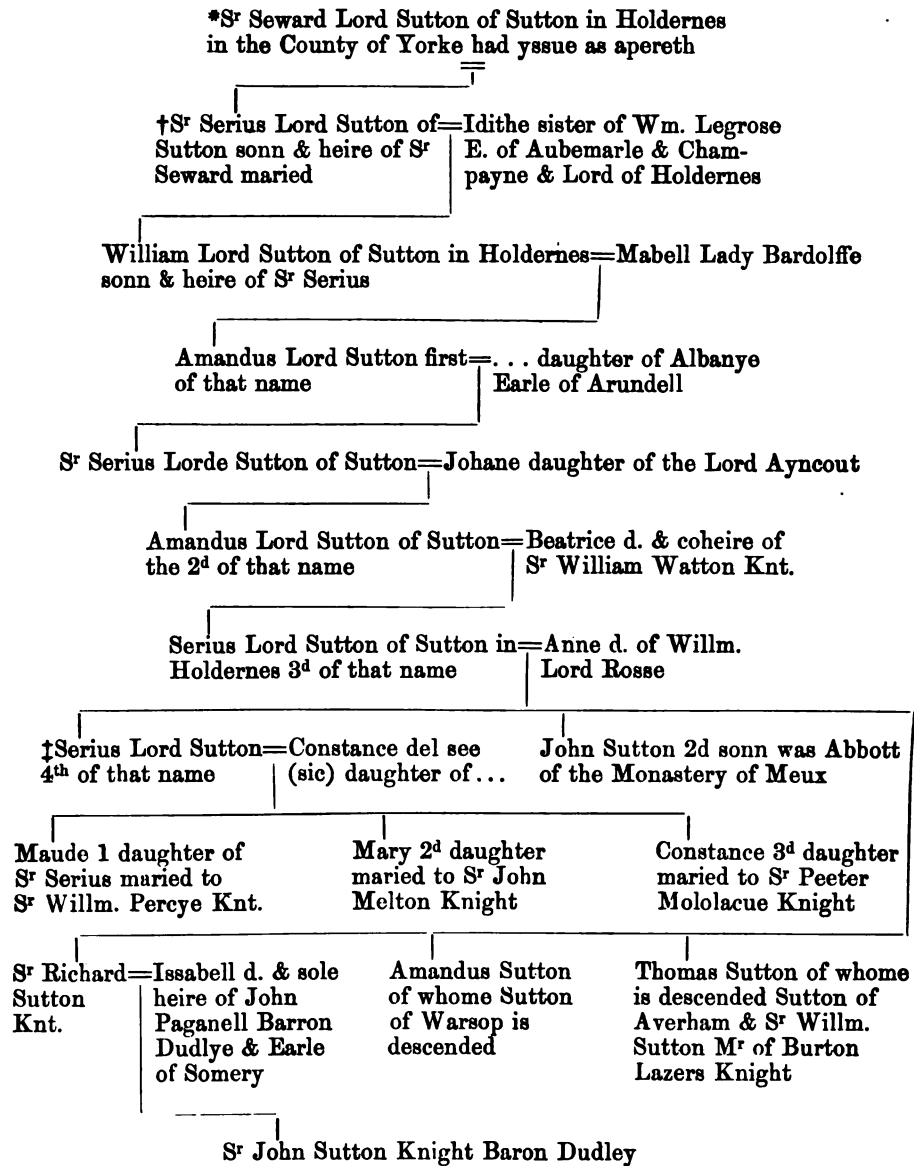

This descent or pettegree was taken out of an old booke of Euidences kept in the Abbay of Meux from the foundation of the same Abbay wch was in King Henery the First tyme vnto the rasing downe of the same Abbay in the tyme of King H. 8. this Abbay was founded by William Legrose Earle of Albemarle and Champayne wch was neare cossen to William the Conqueror & came into England with him wch William Conqueror did giue vnto him the County of Holdernes within the County of York wheare this Abbay of Meux did stand this booke was in the keeping of M<sup>r</sup> Estofte when this copie was taken out of it by Edmond Knight al's Chester Herald of Armes A<sup>o</sup> dni 1565 in the 7<sup>th</sup> yeare of Queene Elizebeth.

\* This Lord Seward Sutton liued at the time that the puisant and victorius prince William duke of Normandy conquered this noble Realme of England.

† This S<sup>r</sup> Serius Lord Sutton gaue lands to the Abbay of Meux in the 2<sup>d</sup> yeare of king Stephen as apereth by the same booke of Euidences where the genealogye of his noble Auncestors were Continually preserued till the Rasing downe of the same monastery.

‡ This 4<sup>th</sup> Serius Lord Sutton lyeth buried at Sutton in Holdernes with the Lyon with the doble tayle one his sheild.



## Fitz-Randolfe.

(Harl. 1400.)

ARMS. *Argent, a chief indented azure.*

CREST. *On a chapeau or turned up azure a wivern of the last.*

A letter from king Hen. 8 under his owne hand in the 34 yeare of his reigne to Christopher Fitz-Randolphe Esq. to Leuy all such forces as were within his Stewardship as Steward to his Ma<sup>tie</sup>.

Another letter from H. 8 vnder his hand to x<sup>p</sup>ofer Fitz Randolph for the Leuying forces for the Duke of Norff. to goe against the Scotts in the 34 yeare of his Reigne.

Christopher Fitz-Randolfe Esq. of=Joane vel Jane da. & coh. of Cuthbert Langton of Midleton in Com. Warr. A<sup>r</sup>  
Langton Hall in Com. Nott.

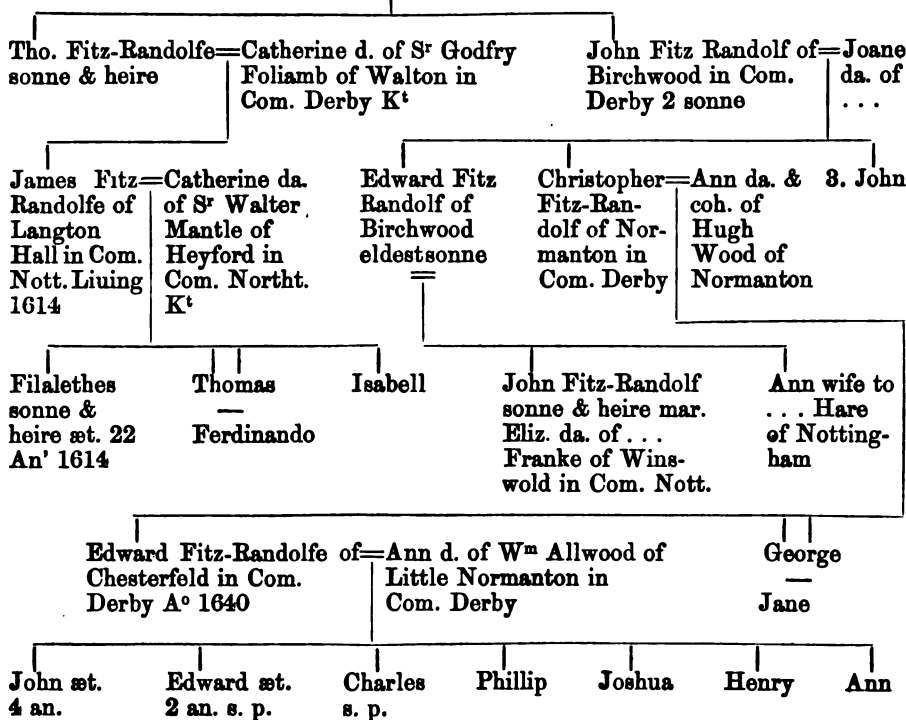

Omnib' xpi fidelib' ad quos hoc p'sens scriptum p'uen'rit Cuthbt' Langton de Midleton in Com. Warr. gentleman Salut' Sciat' me dedisse concessisse &c. Joh'is Markham Milit', Joh'is Souch Milit', Jo. Willowby Ar', Joh'is Fitz-Randolfe Ar', Edw. Willowby Ar', Nicho' Strelley Ar', Joh'is Sauage Clico', & Aliis, omnia Man'ia terr' & tenementa mea in westwood hall al's dict' Langton Hall, Hucknalls Tarkerd, durty Hucknall, Mansfeld woodhous, Kirkby in Ashfeild, & walthow Chaworth in Com. Nott', & Birchwood in Com' Derby, int' Cuthb'ta ex vnæ p'te & xpoferu' Fitz-Randolfe ex alter p'te Sciat'is de maritagio int' xpofer' Fitz-Randolfe Consanguiniu' ipsius xpoferi & Johanna Langton unam filiar' & hered' apparent' p'dict' Cuthbert An<sup>o</sup> 6 H. 8.

## Knights of Darby and Nottingham in the time of King Edward the first.

- SIR WILLIAM DE MOUNTGOMERY:—Or, an eagle displayed azure.  
 SIR JOHN DE LANGFFORD:—Paly of six or and gules, a bend argent.  
 SIR HUGH DE CULY:—Argent, a chevron sable between three pellets.  
 SIR JOHN DE SORPEY (STEPEY Harl. 1400):—Azure, a cross or fretty gules.  
 SIR JOHN LE FAUCONER:—Argent, three falcons belled gules.  
 SIR RICHARD DE HERTHULL:—Argent, two bars vert.  
 SIR ROBERT DE POUTRELL:—Or, on a bend azure three fleurs-de-lis argent.  
 SIR PERS PYCOTT:—Azure, a bend engrailed between six martlets or.  
 SIR WALTER HACKETT:—Argent, two bends gules.  
 SIR THOMAS DE NEWMARCH:—Argent, a fess indented gules.  
 SIR JOHN DE NEWMARCH:—Gules, a fess indented or.  
 SIR ROBERT DE ROS:—Gules, three water bougets ermine.  
 SIR JOHN DE ROS:—Argent, three water bougets sable.  
 SIR NICHOLAS DE HASTINGS:—Or, a maunch gules, a label azure.  
 SIR JOHN DE VAUS:—Chequé argent and gules, a label azure.  
 SIR JOHN DE LOUDHAM:—Argent, on a bend azure three cross crosslets or.  
 SIR JOHN DE HARRINGTON:—Argent, a chief gules, a bend azure.  
 SIR FRANCIS DE VILLERS:—Gules, billetté and a cross or.  
 SIR JOHN BURDON:—Gules, three pilgrims' staves meeting in base argent.  
 SIR WALTER TOUKE:—Sable, billetté or, a canton ermine.  
 SIR JOHN STRECHLEY:—Argent, an eagle displayed sable.  
 SIR THOMAS MALETT:—Gules, a fess ermine between six oval buckles or.

Here ends the Knights in E. II. (*sic*) time.

- AYRE:—Gules, three doves argent, beaked and legged or.  
 SIR THOMAS RAMSTONE:—Argent, a chevron and in dexter chief a cinquefoil sable.  
 HETON:—Argent, six trefoils 3, 2, and 1 vert.  
 BAXTER (per GUYAN, KING OF ARMES):—Ermine, on a chevron gules three bezants.  
 HERTLEY OR HETLEY OF STIRTON:—Azure, three bars argent on a chief of the last as many escallops gules.  
 MUSTON OF GOTHAM:—Or, a chevron between three swords' points upwards gules.  
 METHLEY OF ESTLEY:—Barry of six sable and argent, on a chief of the last (?) three mullets pierced of the first.  
 ILLINGWORTH:—Argent, a fess or flory counterflory sable between three escallops of the last.  
 BINGHAM:—Or, on a fess between three mullets gules as many water bougets argent.  
 PICKERING:—Gules, on a fess argent between three fleurs-de-lis or as many hurts.  
 SIR WILLM. BABINGTON:—Argent, ten torteaux, a label azure (Harl. 1400).  
 SIR THOMAS CHAWORTH:—Quarterly 1 and 4. Azure, two chevrons or. 2 and 3 Sable, an escutcheon within an orle of cinquefoils argent (Harl. 1400).

**OGLETHORPE OF KYNNALTON**:—Argent, a fess dancetté charged with a mascle between three boars' heads sable.

**CREST.** A boar's head argent coupé and vulné gules, pierced with a broken spear, the staff or, the point argent, and charged on the neck with a mascle sable (Harl. 1400).

**MONOX**:—Azure, on a chevron embattled counter-embattled or between three herons argent a leopard's face between two fleurs-de-lis gules.

**CREST.** A demi heron argent, wings gules, in the mouth a flower or, slipped and leaved vert (Harl. 1400).

**HATFEILDE OF WILLOUGHBY**:—Ermine, on a chevron sable three cinquefoils or (Harl. 1400).

**WHITE OF TUXFORD**:—Gules, a chevron engrailed vair between three lions rampant or.

**CREST.** Out of a coronet argent a demi-eagle sable (Harl. 1400).

**JOHN ALESTREE PRIOR OF THURGARTON**:—Three keys erect.

**JOHN HARISON**:—Quarterly. 1 and 4. Argent, a fess flory counterflory gules between three anchors sable. 2 and 3. Argent, a fess gules between two cotises engrailed sable.

**GRENOULD**:—Quarterly. 1. Argent, on a chevron sable three bucks of the field. 2. Barry gules and argent, a label azure. 3. Or, a chevron gules. 4. Sable, a chevron between three mullets or, a bordure of the last.

**BARKER OF SOUTH LEVERTON**:—Argent, three piles meeting in base vert, over all a chevron gules.

**LEWES OF HEDON**:—Sable, a bend ermine between six owls argent.

**TEE OR TYE**:—Gules, on a chevron between three tigers argent as many roses of the field.

**CREST.** A tiger's head erased argent.

**ROBERT BROWNE OF NEWARKE**:—Per pale gules and sable, on a chevron engrailed argent between three leopards' faces as many escallops azure.

**CREST.** A heron azure, head and wings gules, beaked and legged or, collared . . .

**SUTTON**:—Azure, on a chief or a lion rampant between two squirrels sejant gules.

**STANTON**:—Argent, two chevrons sable.

**CREST.** On a mount vert, a tiger proper.

**WYLDE OF NETLEWORTH (p' GILBERT DETHICK, Garter)**:—Or, a fess between three bucks' heads erased sable.

**CREST.** A demi buck sable, attired unguled and gorged with a coronet or.

**WYLDE OF NETLEWORTH**:—1 and 4. Sable, a chevron engrailed argent, on a chief of the last three martlets of the field. 2 and 3. Or, a fess between three bucks' heads erased sable attired gules.

**CREST.** A demi buck sable, attired unguled and gorged with a coronet or.

**THOMAS GUNTHORPE OF TUXFORD IN THE CLAY (this stands in the Church there)**:—Gules, a bordure and bend gobonated argent and azure, on the bend between two lions' heads erased of the second three leopards' faces or.

**LEVETT OF NORMANTON**:—Sable, a fess embattled counter-embattled between three wolves' heads erased argent.

**PLUMPTREE**:—Argent, on a saltire sable five fleurs-de-lis or.

**DENMAN**:—Argent, three lions' heads erased gules.

WODESONN OF LOWDHAM AND GUNTHORPE:—Gules, on a chief argent three quatre-foils vert.

CREST. Out of a coronet or a flame of fire proper.

ASLACTON OF ASLACTON:—Argent, a fess fusilly gules, on each fusil an escallop or.

CREST. A cock's head erased sable, combed and wattled gules.

HOLLAND:—Three lions' gambes erased.

BAWDRIK:—Sable, a chevron argent erased surmounted by another humetté gules.

SIR RICHARD WHATTON OF WHATTON, as on his shield on his tombe in Whatton Church, and in other places there:—Argent, on a bend sable between six cross crosslets gules three bezants.

HENRY STANLEY OF SUTTON BONINGTON:—Or, three eagles' legs erased gules, on a chief indented azure as many bucks' heads cabossed or.

CREST. An eagle's head or, charged on the neck with three pellets 2 and 1, in the beak a leg as in the arms.

The following coats are tricked on the last page of Harl. 1555.

LACOCK OF NOTTINGAME OR LYNCOLNE:—Argent, a dexter gauntlet sable, garnished or.

CREST. A cock argent, combed wattled and legged gules, and holding in his dexter claw a gauntlet as in the arms.

PLUMTREE OF NOTTINGHAM:—Argent, a chevron between two mullets pierced in chief and an annulet in base sable.

CREST. A phoenix argent out of fire proper.

(Harl. 1400.)

Disclaymed at Nottingham the 23 of Septemb' 1614, these names who were Liueing within the wapentakes of Bingham Rusheliff & Broxtow within the said County of Nottingham.

ROBERT PORTER OF BINGHAM.  
 THOMAS SHIPMAN OF SCARINGTON.  
 HUGH KIRCHINEE OF ORSTON.  
 JEWELL BARNARD OF EASTBRIDGFORD.  
 FRANCIS KILBORNE OF STANFORD.  
 WILL'M RICE OF COSHALL.  
 NICHOLAS STREY OF BEESTON.  
 HENRY BROCK OF BROXTON.  
 GEOFFRY BROCK OF BASFORD.  
 GEORGE HOBSTAFF OF EASTWOOD.  
 HENRY PYM OF CHELLWELL.  
 RAPHE SOMERSHALL OF MANSFELD.

## INDEX OF NAMES.

Names in CAPITALS are headings of pedigrees.

„ *italics* have their arms blazoned.

„ brackets ( ) are maiden names.

„ „ [ ] are titles, etc.

- Abdey, —, 113.  
 Abell, Edward, 165.  
     Lucey (Sachoverell), 165.  
 Abney, Mary (Brookesby), 134.  
     Paule, 134.  
 Aderley, Elizabeth (North), 82.  
 Adripan, —, 105.  
*Adrypon*, 105.  
*Ager*, 136.  
 Ager, Henery, 136.  
     Hugh, 136.  
     — (Urswick), 136.  
 Albany [E. of Arundell], 186.  
 Albiniacus, Odinellus de, 79.  
 Aldham, John, 46.  
     Merabell, 107.  
 Aldredg, Anne, 21.  
 Aleby, Gaufridus de, 52.  
     Gilbertus de, 52.  
     Nigellus de, 52.  
     Rapeius de, 52.  
     Thomas de, 52.  
*Alestree*, 189.  
 Alford, Francis, 132.  
     Lancelott, 132.  
*Alfreton*, 132.  
 Alfreton, Alice, 132.  
     Avice, 132.  
     Radulphus de, 132.  
     Robertus de, 132.  
     Thomas de, 132.  
     William, 132.  
     Williamus de, 132.  
 Algar, Atsur, 52.  
 Allen, Anne (Wase), 173.  
     George, 173.  
 Allington, Cordelia, 7.  
     Joane (Cordall), 7.  
     Richard, 7.  
 Allwood, Ann, 187.  
     William, 187.  
 Alphew, Dorathey, 184.  
     Edmond, 184.  
     Elizabeth, 184.  
     Bridgett, 184.  
     Joane, 184.  
     John, 184.  
     Margerett, 184.  
*Alsop*, 34.  
 Alsop, Joane, 34.  
 Alvy, Catherin (Hunt), 167.  
 Amersonn, Elizabeth (Wase),  
     173  
     Thomas, 173.  
 Amias, Percivall, 64.  
 Anastan, Gilbert de, 44.  
     William de, 45.  
 Andersonn, Mary, 98.  
     Elizebeth, 130.  
     Thomas, 98.  
     George, 130.  
 Angeville, Thomas, 105.  
 Angevine, Thomas, 105.  
 Anne, Elizabeth (Nevell), 65.  
     Martyn, 65.  
*Annesley*, 123, 125, 146.  
 Annesley, Amye (—?—), 125.  
     Alice, 127.  
     Sir Hugh, 146.  
     Issabell, 146.  
     Joane de [Vis. of Notting-  
     ham], 45.  
     John de, 125.  
     Sir John de, 125, 126.  
     Thomas, 126.  
     William, 126.  
*Annsley*, 125.  
 Annsley, Anne [—?—], 125.  
     John, 125.  
 Ansley, —, 60.  
 Apleby, Agnes (Slory), 87.  
     Alice, 87.  
     Sir Edward, 87.  
     Issabell (Bruse), 166.  
     Margerett, 87.  
     William, 166.  
 Aprecher, Elizabeth (Power),  
     177.  
 Apsley, Catherin, 39.  
     Sir Henry, 39.  
*Arches*, 14 [in note], 64.  
 Arches, Gilbert de, 14.  
     Issabell, 14.  
     Theodania, 14.  
     Theophania, 14.  
 Archer, Afra (Cornwallis), 161.  
     Sir Arther, 161.  
 Arcubus Robertus de, 141.  
*Arden*, 167.  
 Arden, Beatrix, 167.  
     Elizab. (Swinford), 167.  
     Roger, 167.  
     Sir Thomas, 167.  
 Arley, Anne (Warberton), 25.  
 Armstrong, —, 108.  
 Armstrong, Gilbert, 10.  
     Margarett (Byron), 10.  
 Armyn, Bartholomew, 122, 128.  
     Catherin (Chaworth), 122,  
     128.  
 Arraby, Rodbertus de, 52.  
     Rogerus de, 52.  
 Arundell, E. of [Albanye], 186.  
     Margarett (Willoughby), 149.  
     Sir Mathew, 149.  
     Thos. Lord A. of Warder, 149.  
 Ashbye, Catherin (Haselrig),  
     153.  
 Ashe, —, 170.  
 Ashley, Giles, 138.  
     Sibbell, 138.  
 Ashton, Bridgett (Elwis), 30.  
     Edward, 30.  
     — (Randall), 62.  
 Ashton, James, 128.  
     Valencia, 128.  
*Aslacton*, 190.  
 Aslerton, Issabell, 70.  
     William, 70.  
 Astley, Giles, 42.  
     Sibbell, 42.  
 Assaby, —, 167.  
 Aston, Cordelia, 8.  
     Joanne (Littleton), 10.  
     John, 10, 103.  
     Margerett, 78.  
     Mary (Byron), 10.  
     Roger, 8.  
     Rose, 103.  
     Sir Richard, 10.  
 Atherton, Anne (Byron), 10.  
     Catherin (Conyers), 10.  
     Elizabeth (Byron), 10.  
     John, 10, 94.  
     Margerett, 94.  
*Atkinson*, 129.  
 ATKINSON, 129.

- ATKINSON—*continued*.  
 Anne (Morrey), 129.  
 Elizabeth, 129.  
 Elizab. (Chipenham), 129.  
 Joane (Pearsonn), 129.  
 John, 129.  
 William, 129.  
 Thomas, 129.  
 Atwell, 105.  
 Atwell, Anne, 105.  
 Bridgett (Kyme), 105.  
 Christian (Pigott), 105.  
 Christopher, 105.  
 Grace (Okonor), 105.  
 Hamond, 105.  
 James, 105.  
 Joane, 106.  
 John, 105.  
 Julian (Upton), 105.  
 Margerett, 105.  
 Marian, 105.  
 Raffe, 105.  
 Robert, 105.  
 Sir Thomas, 105.  
 Thomas, 105.  
 Ursula (Leech), 105.  
 — (Adripan), 105.  
 — (Bussan), 105.  
 — (Legborne), 105.  
 Aubermarie and Champayne,  
 E. of, 186.  
 Audeley, Eliz. (North), 82.  
*vel* Atherley, 82.  
 Audley, Sir James, 16.  
 Mary, 16.  
 Auk, Beatrix, 105.  
 Sir Geoffrey, 105.  
 Aungell, Anne, 88.  
 William, 88.  
 Aungerville, Lord Robert, 52.  
 Mabilla, 52.  
 Aunslowe, —, 56.  
 Avenell, Robert, 53.  
 Eva (Lemington), 53.  
 Aylesbery, Hugh, 126.  
 Aylesbury, 123, 125.  
 Aylesbury, Catherin (Pabenh-  
 am), 126.  
 Ellinor, 126.  
 Hugh, 126.  
 Issabell (Mortimer), 126.  
 Joane (Bassett), 126.  
 [see note], 126.  
 John, 126.  
 Margerett (Kaynes), 125.  
 Nicholas, 125.  
 Phillip, 125.  
 Richard de, Mr., 125.  
 Robert de, 125.  
 Sir Roger de, 125.  
 Thomas, 126.  
 Sir Thomas, 126.  
 Sir Waller de, 125.  
 William de, 125.  
 — (Somerie), 125.  
 [Sir John, 126.]  
 [Issabell (Strange), 126.]  
 Ayliffe, Elizabeth, 100.  
 Aylisbury, Thomas, 126.  
 Sir William, 100.  
 Ayloff, Elizabeth (Whalley)  
 118.
- Ayloff—*continued*.  
 William, 118.  
 Ayncourt, Lord, 186.  
 Johane, 186.  
 Ayre, 188.  
 Ayscough, 77.  
 AYSCOUGH, 77.  
 Anne, 77.  
 Dorathey, 77.  
 Dorathey (Fitzwilliams),  
 77.  
 Edward, 77.  
 Elizabeth (Cole), 77.  
 Elizabeth (Dighton), 77.  
 Elizabeth (Hansard), 77.  
 Elizabeth (Strelley), 21.  
 Sir Francis, 77.  
 John, 77.  
 Sir Roger, 77.  
 Sir William, 77.  
 William, 21, 77.  
 — (Gibson), 77.  
 — (Roberts), 77.
- Babington*, 150, 188.  
 BABINGTON, 150, 151, 152.  
 Ada de, 46.  
 Alice, 151.  
 Anne (Bevercotts), 172.  
 Anne, 151, 169.  
 Sir Anthony, 7, 24, 152.  
 Arnold, 151.  
 Augustin, 152.  
 Barnard, 18.  
 Beatrix, 151.  
 Sir Bernard, 150.  
 Benedicta (Ward), 150.  
 Catherin, 24, 127, 152.  
 Catherin (Sacheverell), 152,  
 164.  
 Edith (Fitzherbert), 151.  
 Elizabeth, 151, 152.  
 Elizabeth (Traves), 152.  
 Elizabeth (Ormond), 152.  
 Elizabeth (Holcombe), 152.  
 Elizabeth (Frensh), 151.  
 Emme (Knowills), 151.  
 Fayth, 152.  
 Frances, 152.  
 Frances (Markham), 24,  
 152.  
 Francis, 152.  
 George, 172.  
 Henry, 24, 152.  
 Humffrey, 152.  
 Issabell, 120, 151.  
 Issabell (Dethick), 151.  
 Issabell (Bradborne), 151.  
 Jane, 152.  
 Jarvice [Bishop of Wor-  
 cester], 18.  
 Joane (—?—), 152.  
 John, 7, 35, 120, 151, 152,  
 169.  
 Sir John, 150, 152.  
 Margaret, 7.  
 Margaret (Neasfeld), 151.  
 Margerett (Martell), 151.  
 Margerett (Weynman), 151.  
 Margery, 151.  
 Mary (Darcy), 152.  
 Michaell, 152.
- BABBINGTON—*continued*.  
 Nicholas, 151.  
 Norman, 151.  
 Originall, 152.  
 Sir Phillip, 152.  
 Raffe, 152.  
 Richard, 151.  
 Robert, 7, 151.  
 Rowland, 152.  
 Sancia (Stanhope), 7.  
 Scesselv, 35, 151.  
 Sence (Stanhope), 152.  
 Thomas, 137, 164.  
 Sir Thomas, 151.  
 Thomazin (Pollard), 152.  
 Ursula (Clifton), 18.  
 Walter, 152.  
 William, 151, 152.  
 Sir William, 151, 188.  
 Babthorpe, William, 40, 171.  
 — (Sotehill), 171.  
 Barbara (Constable), 40.  
 Bacon, Edmond, 162.  
 Elizab. (Cornwallis), 162.  
 Bagott, Joanne, 163.  
 John, 163.  
 Bailes, Bryan, 69.  
 Bainbridg, Elizabeth, 79.  
 John, 79.  
 Baius, Rodbertus de, 53.  
 Baker, 36.  
 BAKER, 36.  
 Anne, 36.  
 Anne (Pilkington), 36.  
 Bridgett (Powtrell), 36.  
 Catherin, 36.  
 Elizabeth, 36.  
 George, 36.  
 Jane, 36.  
 Jeremy, 36.  
 John, 36.  
 Margaret, 36.  
 Margaret (Huddeston), 36.  
 Mary, 36.  
 Mary (Eyton), 36.  
 Richard, 36.  
 Thomas, 36.  
 — (Hyde), 36.  
 —, 137.  
 Ball — (Hollis), 62.  
 Ballard, 104.  
 BALLARD, 104.  
 Anne, 104.  
 Anne (Lunn), 104.  
 Catherin, 104.  
 Edward, 170.  
 Elizabeth, 104.  
 Elizabeth (Townesend), 104.  
 Henery, 104.  
 Joane (Fitzwilliams), 104.  
 Phillip, 104.  
 Thomas, 104.  
 Vallentyne (Rolston), 170.  
 William, 104.  
 —, 35.  
 Ballow, Edith, 177.  
 Balston, John, 22.  
 Catherin (Michell), 22.  
 Barber, Dionis, 100.  
 Bard, Thomas, 106.  
 Margerett (Yerburgh), 106.  
 Bardolph, Lord, 6.

- Bardolph—*continued*.  
 Hawis (Cromwell), 6.  
 Mabell, Lady, 186.  
 Barentyne, Mary (Read), 184.  
 Sir William, 184.  
 Barkeley, Lord Henry, 8.  
*Barker*, 189.  
 Barker, Francis, 4.  
 Barkley, Thomas, 133.  
 Emme (Brookesby), 133.  
 Barley, Humfrey, 159.  
 Elizabeth (Beresford), 159.  
 Elizabeth (Chaworth), 127.  
 Thomas, 127.  
 Barlow, —, 131.  
*Barnard*, 177.  
 BARNARD, 177.  
 Abell, 177.  
 Anne, 177.  
 Anne (Hewstas), 177.  
 Edith (Ballow), 177.  
 Jewell, 190.  
 Joell, 177.  
 John, 177.  
 Margery, 177.  
 Mary, 177.  
 Sara, 177.  
 Sara (Stoxes), 177.  
 Susan, 177.  
 Thomas, 177.  
 William, 177.  
 Barnlake, Mary (Engaine), 126.  
 Sir William, 126.  
 William, 126.  
 Baron al's Barnes, Mary, 88.  
 Bartholmow, 88.  
*Barre*, 142.  
 Barre, Agnes, 142.  
 Sir John, 142.  
 Barrett, Dorathey, 108.  
 Joane, 91.  
 Joyce (Reynes), 108.  
 Vallentyne, 91.  
 William, 108.  
*Barrey*, 107.  
 Barrow, Anne, 162.  
 Barry, Maud, 107.  
 Richard, 48.  
 Thomas, 107.  
 Barton, Dorathey (Cartwright), 110.  
 Thomas, 110.  
*Bartram*, 141, 142.  
*Bartram* [scal], 141.  
 Bartram, Alice, 144.  
 Lucia, 141.  
 Sir Rowland, 141.  
*Barwick*, 179.  
 Barwick, Avery, 180, 181.  
 Anne, 76, 181.  
 Bridgett, 134, 181.  
 Edith (Cornwallis), 161.  
 Elizabeth (Marmyon), 181.  
 Gabriell, 176, 181.  
 Margerett (Curson), 180.  
 Mary (Pennington), 181.  
 Robert, 134.  
 Thomas, 180.  
 William, 180.  
 Basford, Margarett, 174.  
 Basford (Bassett), 42.  
 Basill, Thomas, 45.  
 Basille, Robert, 120.  
 Basilye — (Strelley), 19.  
 Bassano, Daniell, 25.  
*Bassett*, 41, 42, 123, 126, 143.  
 BASSETT, 41, 42, 170.  
 Agnes (Borough), 42, 170.  
 Alexander, 42.  
 Alice (Driby), 42.  
 Alice (—?—), 138.  
 Alice (Orby), 138.  
 Alice, 42, 138.  
 Anne, 42, 68, 170.  
 Anne (Rhodes), 42.  
 Catherin, 42, 143, 170.  
 Catherin (Sutton), 42.  
 Clinton, 42.  
 Dorathey, 42, 170.  
 Edmond, 42.  
 Edward, 42, 59, 138.  
 Elinor, 42.  
 Elizabeth, 42, 138.  
 Elizabeth (Colevill), 41.  
 Elizabeth (Donham), 42, 170.  
 Elizabeth (Lascells), 42, 59.  
 Elizabeth (Piggott), 42.  
 Ellinor, 138.  
 George, 42.  
 Henry, 42.  
 Issabell (Boteler), 41, 138.  
 Jane (Staunton), 9.  
 Joane, 126.  
 — [in note], 126.  
 Johannes, 170.  
 John, 42, 170.  
 Margarett, 42, 124.  
 Margarett (Meering), 42.  
 Margery (Mering), 13, 170.  
 Mary, 42.  
 Maud, 24.  
 Raffe, 123, 124, 125.  
 Sir Raffe, 41, 124, 138.  
 Rauffe, 41.  
 Sir Rauffe, 42.  
 Radulphus, 81, 170.  
 Richard, 42, 68, 125.  
 Ricardus, 170.  
 Sir Richard, 42, 170.  
 Robert, 41, 42.  
 Robertus, 170.  
 Sibell (Astley), 42.  
 Sibell (Ashley), 138.  
 Sibell (Colvile), 138.  
 Simon, 41, 138, 170.  
 Simond, 41.  
 Thomas, 13, 42, 170.  
 Sir Thomas, 143.  
 William, 42, 170.  
 Sir William, 41, 138.  
 Willielmus, 170.  
 — (Lyseux), 41, 170.  
 [of Sapcott, Lord, 41, 42.]  
 Bates, —, 85.  
 Batte, Marg. (Elwis), 21.  
 William, 29.  
*Baudrick*, 190.  
 Bawdwyn, Frances, 158.  
 Thomas, 158.  
 Bawme, Bridgett (Eyre), 43.  
 Thomas, 43.  
 Bawnes, Henricus de, 53.  
*Baxter*, 188.  
 Bayly, Alice, 173.  
 Baxter—*continued*.  
 John, 173.  
 Mary (Cludd), 101.  
 William, 4.  
 —, 104.  
 Baynham, Anne, 22.  
 Joane, 21, 22.  
 Sir George, 21, 22.  
 Beaston, —, 65.  
 Beauchamp, Issabell, 124.  
 William, 124.  
 Beauford, John, 127.  
 Margery (Chaworth), 127.  
 Beaumont, Eliz. (Bourchier), 7.  
 Henry, 7.  
 John, 34.  
 Margaret, 10.  
 Marys, 87.  
 Scisseley, 34.  
 Thomas, 87.  
 — (Bassett), 42.  
 Beckard, Eliz. (Molineux), 72.  
 Beckingham, John, 46.  
 Beckwith, Ellen, 58.  
 Mary (Samon), 35.  
 William, 35.  
 Beecher, Henry, 39.  
 Margarett, 39.  
 Bekering, Sir John, 12, 23.  
 Maud, 12.  
 Millescent, 23.  
 Belcher, William, 38.  
 Christian (Dabridgcourt), 38.  
 Belfold, Francis, 116.  
 Ursulow (Whalley), 116.  
 Belgrave, Margarett, 43.  
 Margarett (Willoughby), 146.  
 Thomas, 43.  
 William, 146.  
 Bolin, Scisseley (Poole), 27.  
 Bollin, *vet.*, 27.  
 Belknap, Elizabeth, 7.  
*Bell*, 34.  
 Bell, Dorathey, 34.  
 John, 34.  
 Bellamy, William, 4.  
 Bellases, Sir Thomas, 31.  
 [Lord Falconbridge], 31.  
*Bellaqua*, 160.  
 Bellaqua, Alice, 160.  
 John de, 160.  
 Lucey, 160.  
 Bellers, Agatha (Bingham), 52.  
 Alice, 5.  
 Elizabeth (Howby), 58.  
 Hamondus, 52.  
 Hamund, 52.  
 Johannes, 52.  
 Jacobus, 52.  
 James, 180.  
 John, 53, 54, 58.  
 Sir John, 58.  
 Katherine (Digby), 54.  
 Mabillia (Aungerville), 52.  
 Margareta, 54.  
 Margareta (Bernake), 52.  
 Margareta (Delaine), 44.  
 Marian, 58.  
 Matilda, 44.  
 Radulphus, 52.  
 Roger, 5.  
 Rogerus, 44.

Bellers—*continued.*

- Sampson, 52.  
 Sibillia (Perers), 52.  
 William, 52.  
*Bellinger*, 105.  
 Benington, Lucey, 94.  
 Richard, 94.  
 Bensted, Edmond, 6.  
 Elizabeth (Cromwell), 6.  
 John, 127.  
 Margery (Chaworth), 127.  
*Beresford*, 169.  
 BERESFORD, 169.  
 Adam, 169.  
 Aden, 169.  
 Agnes (Hassall), 169.  
 Agnes, 169.  
 Allen, 169.  
 Anne, 169.  
 Bennett, 169.  
 Edward, 8.  
 Elizabeth, 169.  
 Ellen (Greene), 169.  
 Frances, 169.  
 George, 169.  
 Hugh, 169.  
 Humfrey, 169.  
 James, 169.  
 John, 169.  
 Laurance, 169.  
 Lucey, 75.  
 Mary, 169.  
 Nicholas, 169.  
 Olivia, 8.  
 Richard, 169.  
 Robert, 169.  
 Rose (Fitzwilliam), 169.  
 Thurstan, 169.  
 Thomas, 169.  
 — (Bresley), 169.  
 Berisford, Christian, 110.  
 Christopher, 110.  
 Bernak, Hugh, 53.  
 John, 53.  
*Bernake*, 136.  
 Bernake, John, 5.  
 Elena (Lymbury), 52.  
 Margaretta, 52.  
 Matilda, 5.  
 Mary, 76.  
 Nicholas, 52.  
 Bernard, John, 46.  
 —, 139.  
 Berroyke, Almere, 20.  
 Best, John, 104.  
 Bestwell — (Flower), 122.  
*Bevercotts*, 171.  
 BEVERCOTTS, 171, 172.  
 Agnes (Holt), 172.  
 Alexander, 172.  
 Alice, 172.  
 Anne, 162, 172.  
 Anna (Hollingworth), 172.  
 Anne (Staynforth), 172.  
 Anthony, 172.  
 Barbara, 172.  
 Barbara (Clarkson), 172.  
 Bridgett, 172.  
 Catherine, 172.  
 Cuthbert, 74, 143, 172.  
 Dorethey, 172.  
 Elizabeth, 172.

BEVERCOTTS—*continued.*

- Ellenor, 172.  
 Ellinora (—? —), 171.  
 Fabella (—? —), 171.  
 Issabella, 172.  
 Jane, 172.  
 Joanna (Byron), 171.  
 Joannæ (—? —), 171.  
 Joanna, 171.  
 Johannes de, 171.  
 John de, 171, 172.  
 John, 172.  
 Mare, 172.  
 Mary, 74, 172.  
 Margeria (—? —), 171.  
 Margeratt (Serleby), 172.  
 Millezacia, 172.  
 Richard, 172.  
 Richard de, 171.  
 Ricardus, 171, 172.  
 Samwell, 162 [Bevercotes].  
 Sawell, 172.  
 Scisseley (Constable), 172.  
 Sence, 172.  
 Thomas, 171, 172.  
 William, 171, 172.  
 Willielmus de, 171.  
 Zaunche, 143 [Bevercotes].  
 — (Leigh), 172.  
 — (Rawson), 172.  
 Billing, Isabell, 106.  
 Sir John, 105, 106.  
 Margaret (Tey), 105.  
 Sir Walter, 105.  
 Billingay, Anne, 114.  
 John, 114.  
*Bingham*, 121, 142, 169, 188.  
 BINGHAM, 121, 144.  
 Agatha, 52.  
 Agnes, 167.  
 Alice, 142, 144.  
 Alice (Bartram), 144.  
 Anna, 121.  
 Anna (Strelley), 121.  
 Anne (Strelley), 20.  
 Edmond, 144.  
 Elizabeth, 166.  
 Elizabeth (Charnells), 121.  
 Joane, 60.  
 Johannes, 121.  
 Margaret (Frevill), 121, 146.  
 Margeria, 121.  
 Margeria (Rempson), 121.  
 Margery, 15.  
 Richard, 20, 52, 144.  
 Richard de, 45.  
 Ricardus, 121.  
 Sir Richard, 15, 142, 144, 146.  
 Raffe, 166, 167.  
 Robert, 144.  
 William, 144.  
 [Justice], 169.  
*Bingley*, 155.  
 BINGLEY, 155.  
 Dorathey (Reynes), 155.  
 Elizabeth, 155.  
 Elizabeth (Bolton), 155.  
 Francis, 155.  
 George, 155.  
 Gertrude, 155.  
 Gervase, 155.  
 Henery, 155.

BINGLEY—*continued.*

- Hellen, 155.  
 Mary, 155.  
 Richard, 155.  
 Robert, 155.  
 — (Forster), 155.  
 Birketts, Richard, 3.  
*Biron*, 143.  
 Biron, Alice, 143.  
 Elizabeth (Roswell), 21.  
 Sir John, 143.  
 Richard, 21.  
 Birsam, Sir John, 105.  
*Blackden*, 29.  
 Blackden, —, 29.  
 Blackmor, John, 152.  
 Catherin (Babington), 152.  
 Blackenall — [note], 113.  
*Blacknall*, 113.  
 BLACKNALL, 113.  
 Elizabeth, 113.  
 Elizabeth (Burgess), 113.  
 George, 113.  
 James, 113.  
 John, 113.  
 Roger, 113.  
 Thomas, 113.  
 Ursula (Francis), 113.  
 William, 113.  
 Blackwell, Dionis, 136.  
 Mary (Sacheverell), 165.  
 William, 136, 165.  
 Blague, Elizabeth, 112.  
*Blakett*, 153.  
 Blakett, Isabell, 153.  
 John, 153.  
*Bland*, 89.  
 BLAND, 89, 182.  
 Elizabeth, 89.  
 Jane (Nevell), 89, 182.  
 Jane (Stephenson), 89.  
 Joane, 89.  
 John, 89, 182.  
 Margaret, 66.  
 Mary, 89.  
 Michell, 89.  
 Rebecka (Somerscales), 89.  
 Richard, 89, 182.  
 Sir Thomas, 66.  
 William, 89, 182.  
 Blennerhasset, Catherin, 162.  
 John, 162.  
*Blomster*, 64.  
*Blondeston*, 157.  
 BLONDESTON, 157, 158.  
 Alice, 158.  
 Alice (Bradshaw), 158.  
 Anne, 158.  
 Anne (Maxey), 158.  
 Anne (Nedham), 158.  
 Christopher, 158.  
 Dorathey, 158.  
 Elizebeth (Windsor), 158.  
 Francis, 158.  
 Henery, 158.  
 John, 157, 158.  
 Laurauce, 158.  
 Mary, 158.  
 Nicholas, 158.  
 Reginald, 158.  
 Richard, 158.  
 Robert, 157, 158.



- BLONDESTON—continued.**  
 Thomas, 158.  
 William, 158.  
   — (Haslake), 158.  
   — (Jepsay), 158.  
   — (Jopsay), 158.  
**Blount, Elizabeth**, 18, 60.  
   Elizabeth (Lister), 60.  
   Ellen (Byron), 9.  
   Mary (West), 60.  
   Sir Michell, 60.  
   Richard, 60.  
   Sir Richard, 60.  
   Thomas, 18.  
   Walter, 9.  
   William, 60.  
**Blundeville**, 99.  
**Blundeville, Constance**, 99.  
   Constance (Gourney), 99.  
   Edward, 99.  
   Elizabeth (Boswell), 99.  
   Elizabeth (Ingloe), 99.  
   Elizabeth (Godsalve), 99.  
   Raphe, 99.  
   Richard, 99.  
   Sir William, 99.  
   William, 99.  
**Blunt, Edward**, 167.  
   Issabell (Hunt), 167.  
   John, 167.  
**Blyth, Elizabeth**, 68.  
   William, 68.  
**Bolle**, 94.  
**BOLLE or BOLLES**, 94, 95.  
   [also Bolls.]  
   Abbigale, 95.  
   Anne (Goodericke), 94.  
   Benjamin, 94.  
   Bonaventure, 94.  
   Elizabeth, 95.  
   Elizabeth (Perkins), 95.  
   John, 95.  
   Joseph, 95.  
   Judith, 95.  
   Lucy (Watts), 94.  
   Margarett (Rawson), 94.  
   Mary, 95.  
   Mary (Witham), 95.  
   Samwell, 95.  
   Thomas, 95.  
   William, 94, 95.  
   " [note], 94.  
**Bollin vel Belin**, 27.  
**Bollingbrook**, 77.  
**Bolton, Elizab.** 155.  
**Bond, Anne**, 109.  
   Ellen (Molineux), 73.  
   John, 73.  
**Bonnington, William**, 164.  
   Mary (Sacheverell), 164.  
**Booth, Anne**, 163.  
   Alicce, 17.  
   Catherin (Lascells), 57.  
   Helen (Lascells), 57.  
   Jane (Sacheverell), 164.  
   John, 9, 17.  
   Margery, 9.  
   Thomas, 57, 163, 164.  
**Borough [or Burgh]**, 42.  
   Agnes, 42, 170.  
   Issabell (Monbocher), 50.  
   John, 50.  
**Borough—continued.**  
   Thomas, Lord, 42, 170.  
**Bosam**, 180.  
**Bosco, Ernaldus de**, 81.  
   Ernardus de, 81.  
   William de, 81.  
**Bosomon**, — (Willoughby), 147.  
**Bosse, Rodbertus de**, 53.  
**Bosvile**, 54.  
**Bosvile, Achilles**, 64.  
   Alice, 65.  
   Constance (Mountney), 64.  
   Elizabeth, 65.  
   Sir John, 64.  
   Thomas, 64.  
   William, 65.  
   — (Amias), 64.  
   — (Beaston), 65.  
   — (Radcliff), 64.  
**Boswell, Elizabeth**, 99.  
   Alicce, 65.  
   Elizab. (Nevell), 65.  
   Thomas, 65.  
   William, 65.  
**Boteler, Alicce**, 31.  
   Issabell, 41, 138.  
   William, 31, 41, 138, 164.  
   — (Willoughby), 147.  
   — (Sacheverell), 164.  
**Bothomsell**, 23.  
**Bothomsell, Joane**, 23.  
   Sir Nicholas, 23.  
**Bouill, Hugo de**, 52.  
   Robertus de, 52.  
**Bourchier, Humffrey**, 6.  
   Joanna (Stanhope), 6.  
   fulco, 7.  
   Mary (Cornwallis), 162.  
   Ralph, 6.  
   William, 162.  
   [E. of Bath], 162.  
**Boure, Hugo de**, 45.  
**Bovington, Margarett**, 106.  
   Thomas, 106.  
**Bowett**, 160.  
**Bowett, Elizabeth**, 127, 160.  
   Elizabeth (Zouch), 160.  
   Margarett, 127, 160.  
   Nicholas, 127.  
   Sir Nicholas, 160.  
**Bowtort**, 145.  
**Bowyer, John**, 136.  
   Elizabeth (Draper), 136.  
   Sir Edmond, 137.  
   — (Bynde), 137.  
**Boyle, Catherin**, 35.  
   Sir Richard, 35.  
   [V. Dungarven], 35.  
   [E. of Cork], 35.  
**Boys, Bennett**, 27.  
   Thomas, 27.  
**Boyvill**, 16.  
**Boyvill, Anne**, 171.  
   Elizabeth, 171.  
   George, 171.  
   Hugh, 171.  
   John, 171.  
   Richard, 171.  
   Thomas, 171.  
   William, 171.  
**Bozom, Catherin (Markham)**, 24.  
   Sir Henry, 24.  
   Sir Richard, 24.  
**Bozon**, — (Willoughby), 17.  
**Bracebridge, Edith**, 133.  
   Joyce (Willoughby), 147.  
   Richard, 147.  
**Bradborne, Henery**, 151.  
   Humffrey, 165.  
   Issabell, 146, 151.  
   Jane, 165.  
   John, 146.  
**Braddock, Cassandra**, 121.  
**Bradford, Frances**, 97.  
   Robert, 97.  
**Bradshaw, Alicce**, 158.  
   Catherin, 32.  
   Florence, 108.  
   Jane, 115.  
   John, 115.  
   Margarett (Cressy), 41.  
   Robert, 41.  
   Thomas, 32.  
**Bradshawe, Joane**, 116.  
   John, 115.  
**Braham**, 161.  
**Braisford, Alicce**, 132.  
   John, 132.  
**Bramston, Sir Thomas**, 56.  
   — (Franke), 56.  
**Brand, Anne**, 157.  
   Bridgett (Stanton), 181.  
   Jerom, 157.  
   Jeromy, 181.  
**Bray**, 157.  
**Bray, Alicce**, 157.  
   John, 23.  
   Scissely (Markham), 23.  
**Braybrooke, Nicholas**, 126.  
   Sir Reignald, 126.  
**Brecknock, George**, 177.  
   Judith (Power), 177.  
**Brendisley**, 140.  
**BRENDISLEY**, 140.  
   Anne, 140.  
   Beatrix (Nevell), 140.  
   Catherin (Stephenson), 140.  
   Elizabeth (Poole), 140.  
   Francis, 140.  
   Gervase, 140.  
   Jane, 140.  
   John, 140.  
   Mary, 140.  
   Mary (Onley), 140.  
   Robert, 140.  
   Scissely, 140.  
   — (Holmes), 140.  
   — (Kirkby), 140.  
**Brent, Alicce**, 175.  
**Breton, William**, 103.  
**Bresley**, —, 169.  
**Brether, Margerett (Parkins)**, 159.  
**Bretofte**, 33.  
**Bretofte, Catherin**, 33.  
   John, 33.  
   Margarett, 33.  
**Brett**, 123.  
**Brett, Catherin**, 124.  
   Bamburga (Daincourt), 124.  
   Joane le (Hariz), 124.

*Brett—continued.*

Joane, 68.  
 Sir John le, 124.  
 Sir John, 68.  
 Roger, 124.  
 Bretton, Elizabeth, 27.  
 John, 27.  
 Olliffe, 154.  
 Thomas, 154.  
*Brewse*, 145.  
 Bridgwater, — (—?), 83.  
 Briggandyne, Alice (Squier), 83.  
 Brock, Geoffrey, 190.  
 Henry, 190.  
 Brockett, Frances, 83.  
 Sir John, 83.  
 —, 153.  
*Brodbent*, 114.  
 BRODBENT, 114.  
 John, 114.  
 Brokesby, Thomas, 71.  
 Eliz. (Hutchinson), 71.  
*Brome*, 134.  
 BROME, 134.  
 Alice, 76.  
 Alice (Henson), 76.  
 Catherin, 134.  
 Catherin (Odingsells), 134.  
 Dorathey (Cartwright), 134.  
 Elizabeth, 134.  
 Elizabeth (Whitmore), 134.  
 Elizabeth (Holmes), 134.  
 Elizabeth (Snayth), 134.  
 Gervase, 134.  
 Gregory, 134.  
 Henery, 134.  
 Hensom, 134.  
 James, 134.  
 Margerett, 134.  
 Stephen, 134.  
 Thomas, 134.  
 Bromhall, Maud, 37.  
 Sir Richard, 37.  
 Brook, Sir David, 83.  
 Margerett (Butler), 83.  
 Susan (Cranmer), 71.  
 Thomas, 71.  
 Brookes, Alice (Darell), 91.  
 John, 91.  
*Brookesby*, 133.  
 BROOKESBY, 133, 134.  
 Alice (Michell), 134.  
 Anne, 133.  
 Anne (Villers), 134.  
 Anthony, 133.  
 Alice (Sherley), 133.  
 Bartholmew, 133, 134.  
 Bersaby, 134.  
 Bridgett (Barwick), 134.  
 Catherine, 134.  
 Edith (Bracebridge), 133.  
 Elizabeth, 133.  
 Elizabeth (Stanton), 133, 181.  
 Elizabeth (Goodwin), 134.  
 Emme, 133.  
 Emme (Mylles), 133.  
 Frances, 133.  
 Francis, 134.  
 George, 134.  
 Henery, 133.  
 Humfrey, 133.

*BROOKESBY—continued.*

Joane (Franck), 133.  
 John, 133.  
 Margarett (Wake), 133.  
 Margery, 173.  
 Mary, 133, 134.  
 Philip, 134.  
 Rebecka, 134.  
 Richard, 133.  
 Robert, 133, 134.  
 Thomas, 133, 134.  
 William, 133, 173, 181.  
 Brookman, Lora, 117.  
 Broome, Dorathey (Cartright), 110.  
 Thomas, 110.  
 Broughton, Francis, 116.  
 Mary (Roos), 111.  
 Scisseley, 116.  
 Thomas, 111.  
*Brown* [note], 91, 97.  
 Brown, Agnes, 166.  
 Maud (Bruse), 166.  
 Robert, 166.  
*Browne*, 166, 189.  
 Browne, Christopher, 34.  
 Hellen (Harding), 83.  
 Robert, 4, 189.  
 Richard, 34.  
 Sir —, 83.  
 Thomazine (Gonson), 34.  
 Browneley, John, 3.  
 Brownley, Jane (Rolston), 170.  
 Bruce, Lucey, 75.  
 Brunse, Gabriell, 131.  
 Issabell (Dand), 131.  
*Bruse*, 166.  
 „ [in note], 91, 97.  
 Bruse, Sir Adam, 166.  
 Elizabeth, 166.  
 Issabell, 166.  
 Margerett, 111.  
 Margerett (Hawkes), 166.  
 Maud, 166.  
 Peter, 111.  
 Robert, 166.  
 William, 166.  
 Sir William, 166.  
*Buckton*, 161.  
 Buckton, Nicholas de, 45.  
 Phillippa, 161.  
 Robert, 161.  
 — (Tey), 161.  
 — (Tye), 161.  
 Bugg, Elizabeth, 138.  
 Margerett (Turvile), 138.  
 Bulby, Nicholas, 85.  
 Susanna, 85.  
 Bull, Henery, 170.  
 Mary (Rolston), 170.  
*Bulmer*, 64.  
*Burden*, 24.  
 Burden, Elizabeth, 24.  
 John, 50.  
 Sir John, 23.  
 Margerett, 50.  
 Millesent (Bekerin), 23.  
 Nicholas, 24.  
 Burdett, John, 57.  
 Joane, 57.  
 Richard, 51.  
 — (Hollis), 62.

*Burdon*, 188.

Burdon, John, 56.  
 Sir John, 188.  
 Margaret, 56.  
 Bureton, —, 27.  
 Burges, Elizabeth, 113.  
*Burgh*, 160.  
 Burgh, Elizabeth, 148.  
 John, 160.  
 Margerett, 160.  
 Richard [Lord Fitzhugh], 148.  
 Thomas, 148, 160.  
*Burnell*, 99.  
 BURNELL, 99.  
 Acton, 99.  
 Christian, 99.  
 Constance, 99.  
 Constance (Blundevile), 99.  
 Dorathey (Katherynes), 99.  
 Dorathey, 82, 99.  
 Edward, 99.  
 Elizabeth, 99.  
 Elizabeth (Cordall), 99.  
 Francis, 99.  
 John, 99.  
 Thomas, 99.  
 William, 25, 82, 99.  
 Burrell, Dorathey, 22.  
 Willam, 22.  
 Bursye, Edmond, 15.  
 Jane (Hercye), 15.  
 Burton, John, 166.  
 Elizabeth (Marshall), 166.  
 Simon, 53.  
 Bussam, Sir Thomas, 105.  
 Bussey, Jane, 9.  
 Sir John, 9.  
 Bussie, —, 68.  
 Bussy, Edmond, 72.  
 Elizabeth, 72.  
 Jane, 17.  
 John, 17.  
 Sir Jordan, 49.  
 Margerett, 49.  
 Butler, Alice, 9, 76.  
 Sir John, 9.  
 Margerett, 83.  
 Sir Morgan, 76.  
 William, 38.  
 Sir William, 83.  
 — (Delamare), 38.  
 Byfield, Edward, 73.  
 Margaret (Fletcher), 73.  
 Bynde, —, 137.  
 BYROM, 11.  
 Jane (Chaloner), 11.  
 John, 11.  
 William, 11.  
*Byron*, 9, 136.  
 BYRON, 9, 10, 11.  
 Alice, 9, 10, 22.  
 Alice (Butler), 9.  
 Alice (Stretley), 10.  
 Anne, 10, 11.  
 Anne (Molineux), 10.  
 Anthony, 10.  
 Charles, 11.  
 Elizabeth, 9, 10.  
 Elizabeth (Casterden), 9.  
 Ellen, 9.  
 Francis, 11.

BYRON—*continued.*

Jefferey, 10.  
George, 11.  
Gilbert, 10.  
Issabell, 10.  
Issabell (Shelton), 9.  
Jane (Bussy), 9, 17.  
Joanna, 171.  
John, 9, 10.  
Sir John, 9, 10, 11, 22, 116.  
Margaret, 9, 10, 116.  
Margaret (Beaumont), 10.  
Margaret (Fitz Williams), 10.  
Margery (Booth), 9.  
Margery (Fowlesherst), 9.  
Mary, 9, 10.  
Nicholas, 9, 10, 11.  
Sir Nicholas, 9, 17.  
Phillip, 11.  
Raffe, 9.  
Richard, 9, 10, 11, 171.  
Sir Richard, 9.  
Robert, 11.  
Sibell, 9.  
Sibill, 10.  
Thomas, 10, 11.  
William, 11.  
— (Freeman), 10.  
— (Fitz Geoffrey), 9.  
— (West), 11.

*Caignes al's Kaynes, 125.*

Caignes al's Kaynes, Robert de, 125.  
Caily, Thomas, 46, 47.  
Caldecott, Margery (Reynes), 108.  
Caldibut, —, 161.  
*Caltote, 123.*  
Caltote, Alice, 124.  
Catherine (Lo Brett), 124.  
Sir John, 124.  
Campion, John, 46.  
Canterbury, Abp. of [Cranmer], 71, 109.  
Capanett, — (Boyvill), 172.  
Capella, Avica, 19.  
Elizabeth, 19.  
Hugh de, 19.  
Capenhurst, —, 27.  
Carbett, Amicia, 75.  
Robert, 75.  
Roger, 75.  
Carducia, Agnes, 124.  
Beatrix (— ? —), 123.  
Emme, 124.  
Eve, 124.  
Gundred (Delafforte), 123.  
Helwise (Loundes), 124.  
Henry de, 124.  
Hugo de, 123.  
Issabell (Beauchamp), 124.  
Maud, 124.  
Paganus de, 124.  
Patrick de, 124.  
Robert de, 123.  
Thomas de, 123.  
Werburga (— ? —), 123.  
Sir William de, 123.  
William de, 123.  
— (Fitz Williams), 123.  
Caroll, Elizab. (Darrell), 91.

Carr, Elizabeth, 100.  
Richard, 100.  
Bridgett (Chaworth), 128.  
Sir William, 128.  
Carrell, Jane (Reade), 184.  
*Cartwright, 109.*  
CARTWRIGHT, 109, 110.  
Agnes (Cranmer), 109.  
Anne (Cranmer), 71.  
Anne (Bond), 109.  
Anne, 109.  
Charles, 110.  
Christian, 110.  
Christian (Beresford), 110.  
Dorathey, 109, 110, 134.  
Dorathey (Mollineux), 73, 109.  
Edmond, 71, 109.  
Elizabeth, 109, 110.  
Frances, 110.  
Frances (Peckham), 110.  
Foulke, 110.  
George, 73, 109, 110.  
Grace (Dabridgcourt), 38, 109.  
Grace, 110.  
Hugh, 109, 110.  
Jane (Newton), 109.  
Jennett (Legatt), 109.  
John, 109, 110.  
Katherin (Marshall), 110.  
Mary, 110.  
Mary (Perpoint), 110.  
Maud (Coo), 109.  
Paule, 109.  
Peter, 109.  
Robert, 109.  
Rowland, 109.  
Thomas, 109, 110.  
William, 38, 109, 110, 134.  
Caseley, Grace, 113.  
Stephen, 113.  
Casterden, Elizabeth, 9.  
William, 9.  
Castlin, John, 112.  
Mary, 112.  
*Caunton, 23.*  
Caunton, Sir John, 23.  
Cauthorpe, 16.  
*Cave, 166.*  
Cave, Anne, 167, 182.  
Elizabeth (Montague), 24.  
Ellenor (St. John), 60.  
Francis, 139.  
Henery, 167, 182.  
Jane (Vincent), 139.  
Margaret, 13.  
Margaret (Cicell), 96.  
Richard, 24.  
Roger, 96.  
Sir Thomas, 13.  
Thomas, 60.  
Sir Thomas, 13.  
— (Markham), 25.  
Cavendish, Francis, 51, 56.  
Sir William, 51, 56.  
*Caver, 121.*  
*Caythorpe, 77.*  
Chaloner, Jane, 11.  
Thomas, 11.  
*Chamber, 157.*  
Chamber, Beatrex (Arden), 157.  
Catherin (Reynes), 108.

Chamber—*continued.*

Jane, 157.  
John, 157.  
Sir Thomas, 157.  
Sir William, 157.  
William, 157.  
— (Strange), 157.  
Chambers, Ellen, 158.  
Mury, 158.  
Mary (Mantell), 158.  
William, 158.  
*Channell, 77.*  
*Chantrell, 86.*  
Robert, 147.  
Elizabeth, 147.  
Chapman, Humfrey, 93.  
Grace (Eyre), 93.  
Charlton, Alice, 157.  
Anne, 157.  
Nicholas, 157.  
Thomas, 157.  
*Charlton, 157.*  
*Charnells, 169.*  
Charnells, Elizabeth, 121.  
Norman, 121.  
Charnley, Joane, 21.  
Charrons, Joane, 47, 50.  
Sir Richard, 47, 50.  
Chaucer, Thomas, 48, 50.  
Margaret, 48, 50.  
*Chaworth, 123, 188.*  
CHAWORTH, 123, 124, 125, 126, 127, 128.  
Alice (— ? —), 124.  
Alice (Annosley), 127.  
Ankarott (Serlby), 127.  
Anne, 127, 128.  
Anne (Paston), 128.  
Arobolla, 128.  
Bartholemew, 128.  
Bridgett, 128.  
Catherin, 86, 122, 127, 128.  
Catherin (Babington), 127.  
Dorathey, 127.  
Elizabeth, 126, 127.  
Elizabeth (Bowett), 127, 160.  
Elizabeth (North), 127.  
Elizabeth (Compton), 128.  
Fayth, 128.  
George, 122, 127, 128, 164.  
Sir George, 127, 128.  
Gertrud (Leek), 128.  
Gilbert, 128.  
Henery, 127, 128.  
Issabell, 180.  
Issabell (Aylesbury), 126.  
Jane (Vincent), 128.  
Joane (Luttrell), 124.  
Joane, 127.  
John, 86, 124, 127, 128, 160.  
Sir John, 128.  
Laurence, 124, 127.  
Lucey, 128.  
Margery, 127.  
Margery (Delapoole), 124.  
Margerett (Bowett), 127.  
Mary, 128.  
Mary (Bowett), 160.  
Mary (Sacheverell), 127, 164.  
Mary (Knifton), 128.  
Mary (Paston), 128.

- CHAWORTH—*continued*.  
 Nichola (Braybrook), 126.  
 Paganus de, 123.  
 Sir Raffe, 180.  
 Richard, 128.  
 Robert, 127.  
 Thomas, 127, 128.  
 Sir Thomas, 123, 124, 126, 188.  
 Valencia (Ashton), 128.  
 William, 128.  
 Sir William, 124, 127, 160.  
 — (Hudleston), 127.  
*Chawser*, 179.  
 Chawser, Theobald, 179.  
 Cheney, Jane, 73.  
 Catherin (Pabenharn), 126.  
 John, 73.  
 Sir William, 126.  
 Sir John, 16.  
 Cheny, Elizabeth, 90.  
 Cheverell, George, 164.  
 Mary (Sacheverell), 164.  
 Chibnall, John, 147.  
 Elizabeth (Willoughby), 147.  
*Chichley*, 90.  
 Chichley, Florence, 90.  
 William, 90.  
 Childerle, Henricus, 80.  
*Chipenham*, 129.  
 Chipenham, Elizabeth, 129.  
 Elizabeth (Harman), 129.  
 Nicholas, 129.  
 Chiveton, Suanus de, 44.  
 Cicell, Anne, 96.  
 Alice (Walcott), 96.  
 Elizabeth, 96.  
 Margaret, 96.  
 Richard, 96.  
 William [Lord Burley], 96.  
 Clare, E. of [Hollis], 7, 63.  
 Countess of (Stanhope), 7.  
 Clarell, William de, 47.  
 Clark, Jane, 98.  
 Samwell, 98.  
 Clarke, Anne (Markham), 26.  
 Godfrey, 119.  
 Margaret (Mollineux), 74.  
 Margerett, 159.  
 Robert, 26.  
 Rose, 119.  
 Thomas, 74.  
 William, 159.  
*Clarkson*, 92.  
 CLARKSON, 92.  
 Alice, 92.  
 Ann, 92.  
 Barbara, 172.  
 Dorathey, 167.  
 Elizabeth (Rodney), 92.  
 Elizabeth (Hartop), 92, 122.  
 Elizabeth (Williamson), 92.  
 Ellinor, 92.  
 Ester (Fones), 92.  
 Elizabeth, 92.  
 George, 92.  
 Hugh, 92.  
 Issabell (Nevell), 92.  
 John, 92.  
 Judeth, 92.  
 Michell, 92, 122.  
 Mary, 92.
- CLARKSON—*continued*.  
 Penelope, 92.  
 Sanchia (Powtrell), 92.  
 Senc' (Powtrell), 92.  
 William, 92, 167, 172.  
 Clay, Robert, 54.  
*Clayton*, 9.  
*Claxton*, 183.  
 CLAXTON, 183.  
 Anne, 183.  
 Elizabeth (Rodney), 183.  
 Elizabeth, 183.  
 Ellinor, 183.  
 Hester (Fones), 183.  
 Hugh, 183.  
 John, 183.  
 Mary, 183.  
 Michell, 183.  
 Olive, 183.  
 Penelapy, 183.  
 William, 183.  
 — (Hartop), 183.  
 Clifford, Elizabeth, 125, 171.  
 Anne, 17.  
 Lord, 17.  
 Ellenor, 106.  
 Lady francis, 18.  
 Thomas, 106.  
 Thomas, Lord, 171.  
 [E. of Cumberland], 17, 18.  
 Clifton, Jane (Bussy), 9.  
 Sir Gervase, 9.  
 Clifton, Audelia, 7.  
 Avelina, 7.  
 Gervase, 6, 7.  
 Matilda (Stamhop), 7.  
*Clifton*, 33.  
 CLIFTON, 16 [including Clifton and Clyfton].  
 Adelina, 18.  
 Agnes (Gray), 17.  
 Alice (Booth), 17.  
 Alice (Newell), 17.  
 Alice (Digby), 17, 168.  
 Sir Alvere, 16.  
 Sir Alured, 16.  
 Amias, 18.  
 Amphelis (Sampson), 16.  
 Anne, 18.  
 Anne (Clifford), 17.  
 Anne (Stanley), 18.  
 Anneys, 17.  
 Anthony, 18.  
 Barbara, 18.  
 Catherin (Cressy), 17.  
 Clifford, 18.  
 Catherin (D'Arcy), 18.  
 Dorathey, 18.  
 Elizabeth, 18.  
 Elizabeth (Cromwell), 6.  
 Elizabeth (Blount), 18.  
 Elizeus, 18.  
 Emme (Motton), 17.  
 Ezethius, 18.  
 Frances, 18.  
 francis (Clifford), 18.  
 francis, 18.  
 Gamaliell, 18.  
 George, 18.  
 Gervase, 17, 18, 146.  
 Sir Gervase, 16, 17, 18, 60, 55, 56, 154.
- CLIFTON—*continued*.  
 Hester, 18.  
 Hugh, 17.  
 Issabella (Monbocher), 17, 48, 50.  
 Issabell (francis), 17.  
 Jane, 17, 18, 33.  
 Jane (Tayler), 18.  
 Jane (Nevell), 154.  
 Jane (Bussy), 17.  
 John, 18.  
 Sir John, 6, 17, 18, 48, 50.  
 [Lord], 17.  
 Lettice, 18.  
 Mary (Audley), 16.  
 Mary (Nevell), 18.  
 Mary (Egioke), 18.  
 Margaret, 18.  
 Margarett (Perpoint), 17, 55, 56.  
 Parhasius, 17.  
 Penelope (Rich), 18.  
 Protohasius, 17.  
 Richard, 18.  
 Roger, 16.  
 Sir Robert, 16, 17, 33.  
 Robert, 17, 18, 168.  
 Silvanus, 18.  
 Silvester, 18.  
 Thomas, 18.  
 Ursula, 18.  
 William, 17, 18.  
 Sir William, 18.  
 Winifrid (Thwaites), 18, 50.  
 Winifrid (Thorold), 18.  
 Clovell, Mary (Cornwallis), 161.  
*Clyfton*, 16.  
*Cludd*, 103.  
 CLUDD, 103, 104.  
 Alice, 104.  
 Alice (Salley), 104.  
 Amy, 104.  
 Anne, 104.  
 Anne (Hinton), 103.  
 Beatrix, 104.  
 Charles, 104.  
 Edward, 104.  
 Elizabeth, 104.  
 Elizab. (Stevenson), 103.  
 Martha, 104.  
 Mary, 104.  
 Richard, 103, 104.  
 Rose (Aston), 103.  
 Samwell, 104.  
 Susan, 104.  
 Thomas, 103, 104.  
 William, 103, 104.  
 — (Best), 104.  
 — (Brereton), 103.  
 — (Corbett), 103.  
 — (Coston), 104.  
 — (Hopton), 104.  
 — (Orleton), 103.  
 Coape, Sir Anthony, 128.  
 Anne (Paston), 128.  
 Elizab. (Chaworth), 128.  
 Sir William, 128.  
 Cobham, Ann (Sutton), 144.  
 Sir George, 71.  
 Henry, 144.  
 George, Lord, 144.

Cobham—*continued*.  
 Susan (Cranmer), 71.  
 Thomas, 71.  
 William, Lord, 144.  
 Cock, Jane, 175.  
 John, 175.  
 Cockaine, —, 183.  
 Cockayne, Dorathey, 139,  
 Ann (Stanhop), 8.  
 Thomas, 8.  
 Sir Thomas, 139.  
 Cokyn, Elizab. (Boyvill), 171.  
 Colby, Dorathey, 149.  
 Elizabeth (Gilbert), 149.  
 Thomas, 149.  
 Cole, Elizabeth, 77.  
 Leonard, 112.  
 Roger, 77.  
 Theodocia (Rosa), 112.  
 Coles, Anne, 139.  
 Peter, 139.  
 Colevile, Roger, 41.  
 Elizabeth, 41.  
 Colley, John, 172.  
 Bridgett (Bevercotts), 172.  
 Collombell, George, 93.  
 Dorathey, 93.  
 Colly, Agnes, 112.  
 Anthony, 112.  
 Colomore, Clement, 177.  
 Mary (Barnard), 177.  
 William, 177.  
 Colshill, Margaret, 8.  
 Thomas, 8.  
 Columbello, Dorothy, 93.  
 George, 93.  
 Columbine, —, 168.  
 Columridg, Nicholas, 172.  
 Dorothea (Bevercotts), 172.  
 Colville, Sir Hugh, 138.  
 Sir Robert, 138.  
 Sciseley (—P—), 138.  
 Sibbell, 138.  
 Sir Walter, 138.  
 Colwell, Elizabeth, 83.  
 Colwenn, Thomas, 58.  
 Joane (Lascells), 58.  
 Colwick, 9, 86.  
 Colwick, Sir Giles, 86.  
 Comberford, Catherin, 14.  
 Sir Thomas, 14.  
 Comberworth, 16.  
 Comberworth, Sir Richard, 40.  
 Catherin (Bevercotts), 172.  
 Robert, 172.  
 Compton, Elizabeth, 128.  
 Sir William, 128.  
 Comyn, Catherin, 32.  
 Margaret, 72.  
 Constable, 16, 40.  
 CONSTABLE, 40.  
 Alice (Lascells), 58.  
 Anne, 17, 18, 40, 172.  
 Anne (Wentworth), 40.  
 Barbara, 40.  
 Barbara (Suthill), 40.  
 Catherin, 40, 172.  
 Catherin (Comberford), 14.  
 Catherin (Mannors), 40.  
 Christian (Dabridgcourt), 38,  
 40.  
 Dorathey (Owghtred), 40.

CONSTABLE—*continued*.  
 Dorathey (Hilton), 40.  
 Elizabeth, 40, 172.  
 Everild, 40.  
 George, 40.  
 Henery, 40.  
 Jane, 40.  
 Jane (Sotehill), 172.  
 Jane (Conyers), 40.  
 John, 40, 172.  
 Sir John, 14, 18, 40.  
 Joyce (Stafford), 40.  
 Margaret, 40.  
 Margaret (Tirwhitt), 40.  
 Marmaduke, 40, 172.  
 Sir Marmaduke, 14, 40, 172.  
 Maud, 57.  
 Michell, 40.  
 Phillip, 40.  
 Robert, 58.  
 Sir Robert, 17, 38, 40.  
 Roger, 40.  
 Scisseley, 172.  
 William, 40, 172.  
 — (Comberworth), 40.  
 — (Houndgate), 40.  
 Cony, Susan, 143.  
 Thomas, 143.  
 Conyers, Agnes, 100.  
 Cathren, 10.  
 Jane, 40.  
 Lord John, 10.  
 William Lord, 40.  
 Coe, Maud, 109.  
 Cook, Anne, 176.  
 Anne (Goodere), 176.  
 Edward, 176.  
 Henry, 176.  
 Cooke, Beatrice, 7.  
 Elizabeth, 64, 185.  
 Francis, 62.  
 Sir Francis, 185.  
 Frances (Hollis), 62.  
 John, 64.  
 Mary (Eyre), 93.  
 Mary (Sacheverell), 164.  
 Richard, 164.  
 Robert, 93.  
 „ [Clarencieux], 29, 33, *etc.*  
 Cooper, 140.  
 COOPER, 140.  
 Anne, 132, 140.  
 Anne (Mering), 140.  
 Ellinor (Stanhop), 8, 140.  
 Elizabeth, 101.  
 Glyva, 140.  
 Henery, 101.  
 Joane, 140.  
 Olive, 143.  
 Richard, 140.  
 Scisseley (Tolley), 140.  
 Thomas, 8, 140.  
 William, 13, 132, 140, 143.  
 — (Mering), 13.  
 Copland, John Michell a's, 106.  
 Copleston, Jane (Clifton), 18.  
 Copley, Christopher, 41.  
 Elizabeth (Stringer), 85.  
 John, 85.  
 Susan (Cressy), 41.  
 Copwood, Dorathey, 93.  
 Corbett, Peter *et* Thomas, 103.

Cordall, Elizabeth, 99.  
 Joane, 7.  
 John, 99.  
 Sir Richard, 7.  
 Cork, E. of [Boyle], 35.  
 Corkfield, 77.  
 Cornwallis, 161.  
 CORNWALLIS, 161, 162.  
 Afra, 161.  
 Alice, 162.  
 Anne, 162.  
 Anne (Jernegan), 161.  
 Anne (Fincham), 162.  
 Anne (Barrow), 162.  
 Anne (Bevercotts), 162.  
 Catherin, 161, 162.  
 Catherine (Erle), 161.  
 Catherin (Blennerhasset),  
 162.  
 Catherin (Parkes), 162.  
 Charles, 162.  
 Sir Charles, 162.  
 Cordelia, 162.  
 Dorathey, 161, 162.  
 Edith, 161.  
 Edward, 161.  
 Elizabeth, 161, 162.  
 Elizabeth (Staunford), 161.  
 Elizabeth (Molineux), 74, 162.  
 Frances, 162.  
 Henery, 161, 162.  
 Jane (Hansard), 161.  
 John, 161, 162.  
 Sir John, 161.  
 Lucey (Lattimer), 162.  
 Margaret, 162.  
 Margaret (Lowth), 161.  
 Mary, 161, 162.  
 Mary (Sulliard), 161.  
 Mary (Grimston), 162.  
 Phillip, 162.  
 Phillip (Buckton), 161.  
 Phillip (Tirrell), 161.  
 Prudence, 161.  
 Richard, 161.  
 Risley, 162.  
 Robert, 161.  
 Thomas, 74, 161, 162.  
 Sir Thomas, 161, 162.  
 William, 161.  
 Sir William, 162.  
 Coston, —, 104.  
 Cotton, Catherin, 72.  
 Janne (Fitzharbert), 72.  
 John, 72.  
 Coulclough, Anne, 173.  
 Thomas, 173.  
 Coward, Alice (Symcock), 156.  
 William, 156.  
 Coyney, Margaret, 92.  
 Robert, 92.  
 Coyne, Margery, 93.  
 Robert, 93.  
 Cranmer, 70.  
 CRANMER, 70, 71.  
 Agnes, 109.  
 Agnes (Hatfield), 70.  
 Alice, 71, 73.  
 Alice (Lacy), 71.  
 Anne, 71.  
 Dorathey, 71, 120.  
 Edmond, 70, 71.

CRANMER—*continued.*

Elizabeth (Moreton), 71.  
 Elizabeth (Hutchinson), 71.  
 Elizabeth (Crisp), 71.  
 Gilbert, 70.  
 Hugh, 70.  
 Ide (Loughton), 70.  
 Issabell (Aslerton), 70.  
 Issabell, 71.  
 Jane, 71.  
 John, 70, 71.  
 Jonnett (Fretchvile), 71.  
 Margaret (Fitzwilliams), 71.  
 Mary, 71, 120.  
 Richard, 71.  
 Robert, 71.  
 Scisseley (Quadrang), 71.  
 Susan, 71.  
 Thomas, 70, 71, 73, 109, 120.  
 — (Marshall), 70.  
 Crathorne, Thomas, 40.  
 Everild (Constable), 40.  
 Crawnte, Mary, 158.  
 Thomas, 158.  
 Creake, Issabell, 144.  
 Cresholme, Catherin (Cressy),  
 17.  
 William, 17.  
 Cressy —, 176.  
*Cressy*, 16, 95.  
 CRESSY, 41, 95.  
 Alice (Odingsells), 95.  
 Bridgett, 95.  
 Catherin, 17, 95.  
 Catherin (Smyth), 95.  
 Christopher, 41.  
 Dorathey, 85.  
 Elizabeth, 17, 95.  
 Ellinor, 12.  
 Francis, 41.  
 George, 41.  
 Gervase, 41.  
 Henery, 95.  
 Sir Henery, 23.  
 Hugh, 41, 95.  
 Sir Hugh, 12.  
 Hugo, 17.  
 Jane (Hansard), 41.  
 Joane, 95.  
 Sir John, 17.  
 Leonard, 95.  
 Margerett, 17, 23, 41.  
 Margerett (Hall), 41.  
 Mary, 41, 95.  
 Mary (Shaleros), 95.  
 Nicholas, 41.  
 Peter, 41.  
 Robert, 41.  
 Roger, 41.  
 Susan, 41, 95.  
 William, 41, 85, 95.  
 — (Everingham), 41.  
 — (Grice), 41.  
 — (Harrison), 41.  
 — (Hutchinson), 41.  
 — (Portington), 41.  
 Creswell, Richard, 30.  
 Suzan, 30.  
 Creve, John, 45.  
 Crisp, Elizabeth, 71.  
 Croft, Alecia (Slory), 86.  
 Willimus, 86.

*Croftes*, 64.

Croftes, John, 64.  
 Issabell, 64.  
 Mary (Chaworth), 128.  
 William, 128.  
 Croker, Sir Gerard, 139.  
 Cromwell, Alice (Bellers), 5.  
 Elizabeth, 6.  
 Frances, 118.  
 Hawis, 6.  
 Sir Henery, 118.  
 Margaret (Deincourt), 6.  
 Matilda, 6.  
 Matilda (Bernake), 5.  
 Ralph, 5, 6.  
 Ralph, Lord, 47.  
 Robert, 5.  
 Crosby, Bridgett, 90.  
 Crosley, Anne, 135.  
 John, 135.  
*Culy*, 188.  
 Culy, Sir Hugh de, 188.  
 Curson, Alice (Willoughby),  
 148.  
 Elizabeth, 163.  
 Joane, 163.  
 Joanne (Bagott), 163.  
 John, 163.  
 Sir John, 163.  
 Margerett, 180.  
 Margaret (Hussey), 180.  
 Richard, 148, 163.  
 Thomas, 180.  
 Thomazin, 163.  
 Cursonn, John, 28.  
 Scisseley, 28.  
 Curton, Jane, 8.  
 John, 8.  
 Cuttle, Ellen, 65.  
 William, 65.  
 Daberne, Margaret, 175.  
 Robert, 175.  
*Dabridgecourt*, 37.  
 DABRIDGCOURT, 37, 38, 39.  
 Alice (Delamare), 38.  
 Alice (Griswold), 38.  
 Anne, 38.  
 Barbara (Fisher), 39.  
 Barnard, 38.  
 Carew, 39.  
 Catherin, 38.  
 Catherin (Leggatt), 39.  
 Catherin (Apsley), 39.  
 Christian, 38, 40.  
 Dorathey (Puttenham), 38.  
 Dorathey (Molineux), 38,  
 109.  
 Elizabeth, 39.  
 Elizabeth (Wigston), 38.  
 Francis, 39.  
 George, 38, 39.  
 Sir George, 39.  
 Grace, 38, 109.  
 Henery, 39.  
 Jane, 38.  
 Joane, 146.  
 John, 37, 38, 40.  
 Sir John, 37, 146.  
 Katherin (Minors), 38.  
 Lucy, 39.  
 Margerett, 38.

DABRIDGCOURT—*continued.*

Margarett (Beecher), 39.  
 Mary, 38.  
 Maud (Bromhall), 37.  
 Sir Nicholas, 37.  
 Richard, 39.  
 Sanchett, 39.  
 Sir Sanchett, 37.  
 Scisseley, 38.  
 Stephen, 39.  
 Susan, 39.  
 Thomas, 38, 39, 109.  
 William, 38, 39, 109.  
 — (Say), 37.  
 — (Norton), 38.  
 Dade, Thomas, 162.  
 Anne (Cornwallis), 162.  
 Daincourt, Bamburga, 124.  
 John Lord, 124.  
 Dalby, John, 54.  
 Dale, Dorathey, 83.  
 Valentine, 83.  
 Dallisonn, William, 77.  
 Elizab. (Dighton), 77.  
 —, 167.  
 Dampredicourt, Sir Eustace, 37.  
 Elizab. (Wake), 37.  
 Lord, 37.  
 Danby, Dorathey, 108.  
 Scisseley, 58.  
*Dande*, 131.  
 DANDE, 131.  
 Oliver, 131.  
 Dand, Dorathey, 131.  
 Francis, 131.  
 Issabell, 131.  
 Issabell (Todd), 131.  
 John, 131.  
 Margarett, 131.  
 Margery (Woodnoth), 131.  
 Rowland, 131.  
 Timothy, 131.  
 — (Barlow), 131.  
 Danks, Thomas, 178.  
 Mary (Wightman), 178.  
 Darby, William, 106.  
 Barbara (Yerburgh), 106.  
 Darcy, Catherin, 18.  
 Sir Humffrey, 18.  
 Darcy, Catherin, 49.  
 George Lord, 152.  
 John, 49.  
 Mary, 152.  
*Darrell*, 90.  
 DARRELL, 90, 91.  
 Alice, 91.  
 Allicia (Fly), 6.  
 Anne, 90.  
 Ann (Guildeford), 90.  
 Anne (Scott), 90.  
 Anne (Muschamp), 90.  
 Barbara (Denman), 91.  
 Blanch, 90.  
 Brian, 91.  
 Bridgett (Crosby), 90.  
 Christopher, 90.  
 Dorathey, 90.  
 Edward, 6, 90, 91.  
 Elizabeth, 90, 91.  
 Elizabeth (Horne), 90.  
 Elizabeth (Cheney), 90.  
 Elizabeth (Morley), 90.

DARRELL—*continued.*

Ellin, 91.  
Francis, 91.  
Francos, 91.  
Florence (Chicheley), 90.  
George, 90, 91.  
Henery, 90, 91.  
Jane (Knotsworth), 90.  
Joane (Barrett), 90.  
John, 90.  
Margaret, 91.  
Margaret (Darrell), 90.  
Margaret (Gage), 91.  
Margery, 91.  
Mary, 60, 90, 91.  
Mary (Roe), 91.  
Mary (Royden), 91.  
Marmaduke, 90, 91.  
Sir Marmaduke, 90.  
Phillip, 90.  
Rose, 90.  
Stephen, 90.  
Thomas, 90, 91.  
Sir Thomas, 60, 90.  
Thomazin (Gresley), 90.  
William, 90.  
Darwen, —, 112.  
*Daubney*, 24.  
Daubney, Joane, 126.  
Jane, 15, 24.  
Sir Giles, 14, 24.  
Mary (Hercye), 14.  
Daunsonn, Wiborow, 147.  
Davenport, James, 174.  
Sir Humfrey, 174.  
Mary (Moyle), 174.  
[Lord Chief Baron], 174.  
Davis, John, 148.  
Bridgett (Willoughby), 148.  
*Davyll*, 121.  
Dawney, Dorathey, 65.  
Sir John, 65.  
Daybridgcourt, William, 73.  
Dorathey (Molineux), 73.  
Deacon, William [the], 44.  
Deincourt, Margaret, 6.  
Will., Lord, 6.  
Deivile, Stephan, 47.  
Delabogs, Jane, 69.  
John, 69.  
Delafforth, Gundred, 123.  
Delalaund, Issabell, 35.  
Delamara, Alanus de, 51.  
Delamore, Avice (Penris), 37.  
Alicc, 38.  
Anne, 38.  
Elizabeth, 57.  
Jannet (ap Ivangrch), 37.  
John, 37, 38.  
Peter, 37.  
Raffe, 37.  
Robert, 37.  
Thomas, 38.  
Sir Thomas, 37.  
William, 37.  
— (Dabridgcourt), 38.  
— (Mansell), 37.  
*De la More*, 161.  
*Delaplanchc*, 145.  
*Delapoole*, 124.  
Delapoole, Margery, 124.  
Sir Richard, 124.

Delariver, Sir John, 44.  
Matilda (Herize), 44.  
Margarett, 45.  
Richard, 44.  
Delaware, Lord [West], 20, 60, 175.  
Deliton, Maud (Lascells), 58.  
Robert, 58.  
Delwood, Elizab. (Slory), 87.  
Robert, 87.  
Ruth, 74.  
*Denman*, 90, 189.  
Denman, Barbara, 91.  
Francis, 91.  
Densill, Anne, 62.  
John, 62.  
Dethick, Sir Anthony, 127.  
Emme, 164.  
Issabell, 151.  
Joane (Ormond), 127.  
Robert, 151.  
William, 164.  
Dewastnoys, Sir Hardolphe, 67.  
[See Wastnoys.]  
Deynsyll, Alicc, 61.  
Anne, 61, 62.  
Catherin (Skowis), 61.  
John, 61, 62.  
Mary (Lucy), 61.  
Reinfrid, 61.  
Dickins, William, 4.  
*Digby*, 168.  
DIGBY, 168.  
Alicc, 17, 168.  
Alicc (Wallis), 168.  
Benjamin, 168.  
Elizabeth, 14, 122, 130, 168.  
Elizabeth (Nevell), 65.  
Elizabeth (Slaughter), 168.  
Elizabeth (Hartop), 122.  
Everard, 168.  
Sir Everard, 168.  
Grace, 21.  
Jaques (Ellis), 168.  
John, 84, 122, 130, 168.  
Sir John, 14, 168.  
Katherin, 54, 55.  
Liberius, 168.  
Luce (Trigott), 168.  
Margaret, 84.  
Reignald, 168.  
Rowland, 65, 168.  
Sara, 21, 168.  
Simeon, 168.  
Simon, 17, 21, 168.  
Thomas, 65, 168.  
Sir Thomas, 168.  
— (Columbine), 168.  
Dighton, Elizabeth, 77.  
Robert, 77.  
Dinigton, John de, 46.  
Disney, Agnes, 61.  
Anne, 97.  
Catherin, 181.  
Catherin (Molineux), 73.  
Daniell, 73.  
Sir Henery, 97.  
Jane (Dyve), 33.  
Margarett, 33.  
Mary (Molineux), 73.  
Sir Roger, 33.

Disney—*continued.*

Thomas, 61.  
Sir William, 33.  
Dive, Maud, 78.  
William, 78.  
Dixey, Anne (Draper), 137.  
Sir Wolston, 137.  
Dixon, Waterman al's, 28.  
DOBSON, 130.  
Christopher, 98, 130.  
Elizabeth, 130.  
Elizabeth (Thornhill), 130.  
Elizabeth (Andersonn), 130.  
Hugh, 130.  
Jane, 98.  
Joanne, 130.  
John, 130.  
Richard, 130.  
*Dod*, 43.  
DOD, 43.  
Alicc, 43.  
Anne (Kynaston), 43.  
Anne (Sturdivant), 43, 159.  
George, 43.  
Janne (Legatt), 43.  
Randall, 43, 159.  
Richard, 43.  
Susannah, 43.  
Thomas, 43.  
William, 43.  
Dodingsellos Edwardus, 75.  
Hugo de, 75.  
Johannes, 75.  
Emma (— P —), 75.  
Dokesworth, Hugo de, 80.  
Domvile, Margaret, 110.  
*Donham*, 160.  
DONHAM, 160.  
Anne, 14, 160.  
Bennett (Foliambe), 160.  
Catherin, 160.  
Elizabeth, 42.  
Elizabeth (Bowett), 160.  
Elizabeth (Ormond), 127.  
Frances, 160.  
Jane (Thurland), 160.  
John, 42, 127, 160.  
Sir John, 160.  
Mary, 160.  
Nicholas, 14.  
Robert, 160.  
— (Stanford), 160.  
Dormer, Ellin (Hynd), 129.  
John, 129.  
Doyley, Catherin, 94.  
Thomas, 94.  
*Draper*, 136.  
DRAPER, 136, 137.  
Abraham, 137.  
Alicc (Windebank), 137.  
Ann, 137.  
Anne (Hussey), 137.  
Anne (Whalley), 137.  
Bennett, 136, 137.  
Bridgett, 137.  
Clement, 137.  
Sir Christopher, 137.  
Dionis (Blackwell), 136.  
Dorcas, 137.  
Elizabeth (Wymondham), 136.

DRAPER—*continued.*

- Elizebeth (Fifield al's Lowe), 136.  
 Elizebeth (Garston), 137.  
 Elizebeth, 136, 137.  
 Ellenor (Whalley), 118.  
 Frances, 137.  
 Henery, 136.  
 John, 136, 137.  
 Margaret (Goulson), 137.  
 Mary, 137.  
 Mathew, 136.  
 Richard, 137.  
 Robert, 136, 137.  
 Sara, 137.  
 Sibbell (— ? —), 136.  
 Thomas, 4, 118, 136, 137.  
 Vincent, 137.  
 William, 136, 137.  
 — (Ager), 136.  
 — (Kettleby), 136.  
 — (Galle), 137.  
 — (Gunston), 136.  
 Drax, Jane, 101.  
 Robert, 101.  
 Draycott, John, 42.  
 Alice (Willoughby), 148.  
 Catherin (Bassett), 42.  
 Jane, 35.  
 Sir Phillip, 35.  
 Richard, 148.  
 Driby, Alice, 42.  
 John, 42.  
 Drury, Elizebeth, 130.  
 Elizabeth (Sotehill), 172.  
 Sir Robert, 130.  
 Sir William, 172.  
 Dudley, Lord [Paganell], 186.  
 " [Sutton], 186.  
 Dorathay (Lascells), 59.  
 Edward, 87, 88.  
 Elizabeth (Wood), 88.  
 Sir Henery, 83.  
 Margaret (Wood), 87.  
 Thomas, 59, 88.  
 Winifrid (Rich.), 83.  
 Duffell, John, 118.  
 Judith, 118.  
 Rebecka, 118.  
 Dun, Sir Griffin, 127.  
 Elizabeth (North), 127.  
 Dungarven, Vist. [Boyle], 35.  
 Dunigton, Will. de, 43.  
 Dunton, John de, 43.  
 Dynley, Robert, 8.  
 Margaret (Stanhope), 8.  
 Dyon, John, 106.  
 Margaret (Yerburgh), 106.  
 Dyve, Jane, 33.  
 Sir William, 33.  
 EASTWOOD, 91.  
 Anne (Marshall), 91.  
 Charles, 91.  
 Elizabeth (Wood), 91.  
 Issabell (Southworth), 91.  
 John, 91.  
 Thomas, 91.  
 Edmondsonn, Joane, 43.  
 Robert, 43.  
 Egerton, Ellen, 148.  
 Issabell, 28.

Egerton—*continued.*

- John, 28.  
 Sir John, 148.  
 — (Wallys), 148.  
 Egioko, John, 18.  
 Mary, 18.  
 Egremont, Lord [Percy], 148.  
 Eincourte, Lord, 180.  
 Joane, 180.  
 Eland, John, 58.  
 — (Strelley), 19.  
 Elkington, Griffith, 122.  
 Grace (Flower), 122.  
 Ella, 136.  
 Eller, 136.  
 Ellerker, Edward, 40.  
 Elizabeth (Constable), 40.  
 Jane (Constable), 40.  
 Sir Raffe, 40.  
 Ellerton, Will. de, 53.  
 Elliott, Anne, 155, 177.  
 Alice (Delaware), 38.  
 Richard, 155.  
 Sir Richard, 38.  
 Sir Thomas, 38.  
 William, 177.  
 Ellis, Agnes (Marshall), 166.  
 Jacques, 168.  
 John, 168.  
 Thomas, 166.  
 Ellsham, Richard, 4.  
 Elphin, Bishop of [Maxey], 158.  
 Elsam, Anne, 114.  
 Richard, 114.  
 Elton, Sir Myles, 111.  
 Elwis, 29.  
 ELWIS, 29, 30.  
 Agnes, 29.  
 Anne, 29.  
 Barbam, 30.  
 Bridgett, 29, 30.  
 Edward, 29, 30.  
 Elizabeth, 29, 30.  
 Elizabeth (Gabbott), 30.  
 Elizabeth (Hebbs), 30.  
 Frances, 29.  
 Geoffrey, 30.  
 Gervase, 29, 30.  
 Sir Gervase, 29.  
 Henery, 29, 30.  
 Jane, 29.  
 Jeromy, 30.  
 Sir Jerwas, 30.  
 John, 29, 30.  
 Margaret, 29.  
 Mary, 29, 30.  
 Mary (Brooke), 29.  
 Martha (Tirwhitt), 29.  
 Nathaniell, 29.  
 Silvius, 30.  
 Susan (Creswell), 30.  
 Thomas, 29, 30.  
 Troth, 29.  
 William, 29, 30.  
 Sir William, 29.  
 Winifrid, 29.  
 — (Blackden), 29.  
 — (Levesey), 29.  
 — (Shepard), 30.  
 Empson, 49.

- Empson, Jane, 172.  
 Joane, 50, 56.  
 Sir Richard, 50, 56, 172.  
 Engaine, 123.  
 Engayne, Alice (falconbridge), 125.  
 Elizabeth, 126.  
 Joanne, 126.  
 Sir John, 125.  
 Joyce, 126.  
 Mary, 126.  
 Sir Nicholas, 125.  
 Entwesell, Lucy, 153.  
 Mary, 35.  
 Thomas, 35, 153.  
 Erle, Christian (North), 83.  
 William, 83.  
 Escolandus, Radulph., 51.  
 Ribaldus, 51.  
 Esmond, Edith (Ballow), 177.  
 Essington, 153.  
 Essington, Sir Robert, 153.  
 Estofte, Mr. [note], 186.  
 Evans, Thomas, 175.  
 Dorathay (Goodere), 175.  
 Susan (Dabridgecourt), 39.  
 Everard, Jane (Waterton), 159.  
 Richard, 139.  
 Everingham, —, 41.  
 Evers, Elizab. (Willoughby), 184.  
 Margaret, 119.  
 Robert, 119.  
 William, Lord, 184.  
 Eyre, 48, 92.  
 EYRE, 48, 92, 93.  
 Adam, 22.  
 Anne, 48, 93, 139.  
 Anne (Markham), 26.  
 Anne (Ryton), 92.  
 Anne (Reyton), 92.  
 Anne (Sparke), 93.  
 Anne (Nevell), 43.  
 Anne (Leigh), 43.  
 Anne (Stanley), 93.  
 Anne (Yerburgh), 106.  
 Anthony, 26.  
 Bridgett, 43.  
 Dorathay, 93.  
 Dorathay (Collombell), 93.  
 Dorothy (Copwood), 93.  
 Dorothy (Columbell), 93.  
 Edmond, 92, 93.  
 Elizabeth, 93.  
 Ellinor, 43.  
 Fayth (Chaworth), 128.  
 George, 43, 65, 93.  
 Gervois, 93.  
 Gertrude, 22.  
 Grace, 93.  
 Henery, 106.  
 Jane, 26, 69.  
 Jervase, 69.  
 Joane (Edmondsonn), 43.  
 John, 43.  
 Joseph, 43.  
 Margaret, 43.  
 Margaret (Belgrave), 43.  
 Margaret (Coynoy), 92.  
 Margery (Coynoy), 93.  
 Mary, 93, 122.



**EYRE—continued.**

Nicholas, 43.  
 Richard, 43, 93, 136.  
 Rebecka, 93.  
 Robert, 22, 96.  
 Rowland, 22.  
 Sara, 93.  
 Thomas, 93.  
 William, 92, 93.  
 — (Nevell), 65.  
 — (Harwood), 43.  
 Eyton, John, 36.  
 Mary, 36.  
 Fairfax, Guy, 42, 170.  
 Catherin (Bassett), 42, 170.  
 falconbridge, Alice, 125.  
 Walter, 125.  
 Falconarius, William, 79.  
 Falconer, William [the], 79.  
 Fanner, Henery, 161.  
 Jane (Hansard), 161.  
 Faramond, Bennett (Draper),  
 136.  
 John, 136.  
 Farmery, Margaret, 119.  
 William, 119.  
 Farnham, Anne (Eyre), 43.  
 Thomas, 43.  
 Farren, Richard, 74.  
 Fayth (Molineux), 74.  
 Fary, Sara, 113.  
 William, 113.  
 Fauconer, 188.  
 Fauconer, Sir John la, 188.  
 faulkonbridg, Lord (Bellasis),  
 31.  
 Feld, 145.  
 Fencott, 64.  
 Fenton, 33.  
**FENTON, 33, 34, 35, 113.**  
 Agnes (Roulston), 33.  
 Alice (Weston), 34.  
 Anthony, 34.  
 Catherin, 34, 35, 113.  
 Charles, 113.  
 Dorathey (Bell), 34.  
 Dorathey (Staunton), 34.  
 Edward, 34.  
 Elizabeth, 113.  
 Ellenor (Malloy), 33.  
 Ellenor (Revell), 34.  
 Ellinor (Meering), 121.  
 Ellinor (Nevell), 34.  
 Ellinor (Lloyde), 34.  
 Francis, 113.  
 George, 113.  
 Sir Geoffrey, 34.  
 Grace, 113.  
 Grace (Casely), 113.  
 Henry, 33, 34.  
 Hugh, 34.  
 Issabell (Mering), 33.  
 James, 34.  
 Jane (Nevell), 113.  
 Jane (Clifton), 33.  
 John, 33, 34.  
 Joane (Alsop), 34.  
 Joyce, 34.  
 Lawrence, 113.  
 Margaret (Fitzgerald), 35.  
 Margaret (Disney), 33.

**FENTON—continued.**

Mary, 113.  
 Raffe, 34.  
 Sir Richard, 33.  
 Richard, 33.  
 Sara (Fary), 113.  
 Scisseley (Beaumont), 34.  
 Thomas, 33, 34, 113.  
 Thomazine (Gonson), 34.  
 William, 33, 34, 113.  
 Sir William, 35.  
 — (Abdey), 113.  
 — (Burgh), 34.  
 Ferrers, Sir John, 8.  
 Fifeld, *a/s* Lowe, John, 136.  
 Elizabeth, 136.  
 Fitioll, 146.  
 Filioll, Anne, 148.  
 William, 148.  
 Filton, Sir Edward, 56.  
 Elizabeth, 56.  
 Fincham, Anne, 162.  
 Fisher, Barbara, 39.  
 William, 39.  
 Fitz, William, 162.  
 Dorathey (Cornwallis), 162.  
 Fitzallan, 179.  
 Fitzallan, Thomas, 179.  
 Fitzarcher, 12; [note], 117.  
 Fitz Geoffrey, —, 9.  
 Fitz Gerald, Margerett, 35.  
 Morrice, Fitz-Edmond, Fitz-  
 Gibon, 35.  
 fitzharbert, Johanne, 7.  
 John, 7.  
 Margaret (Babington), 7.  
 Fitzharbert, Janne, 72.  
 Nicholas, 72.  
 Fitzherbert, Agnes (Beresford),  
 169.  
 Sir Anthony, 164.  
 Catherin, 164.  
 Dorathey (Willoughby), 148.  
 Edith, 151.  
 Eustace, 15.  
 George, 169.  
 Jane (Mering), 13.  
 Janne, 139.  
 John, 139.  
 Raffe, 151.  
 Thomas, 148.  
 Fitzhugh, Richard, Lord, 148.  
 Fitzjames, Jacob, 109.  
 Jane (Newton), 109.  
 Fitz Randall, Randall, 58.  
 Theophania (Lascells), 58.  
 Fitz Randolfe, 187.  
**FITZRANDOLFE, 187.**  
 Ann, 187.  
 Ann (Wood), 187.  
 Ann (Allwood), 187.  
 Catherin (Foliamb), 187.  
 Catherin (Mantell), 187.  
 Charles, 187.  
 Christopher, 187.  
 Edward, 187.  
 Ferdinando, 187.  
 Filalethes, 187.  
 George, 187.  
 Henery, 187.  
 Issabell, 187.  
 James, 187.

**FITZRANDOLFE—continued.**

Jane, 187.  
 Joane (—?—), 187.  
 John, 187.  
 Joshua, 187.  
 Phillip, 187.  
 Thomas, 187.  
 Fitz William, Lord Raffe, 123.  
 Dorathey, 77.  
 William, 77.  
 Fitzwilliams, 157.  
 Fitzwilliams, Edward, 104.  
 Elizabeth (Ormond), 127.  
 Ellinor (Bassett), 138.  
 Joane, 104.  
 John, 71, 138, 169.  
 Sir John, 50.  
 Margaret, 10, 50, 55, 56, 71.  
 Matilda (Cromwell), 6.  
 Rose, 169.  
 Sir William, 6, 10, 50, 55, 56.  
 Fitz Williams, Edmond, 142.  
 Catherin, 142.  
 Ellinor (Bassett), 42.  
 John, 7.  
 Flamenvilla, Walter de, 51.  
 fletwood, Joyce, 31.  
 Thomas, 31.  
 Sir William, 18.  
 Fletcher, Francis, 73.  
 Frances (Molineux), 73.  
 John, 73.  
 Margarott, 73.  
 Mury, 73.  
 Molineux, 73.  
 Robert, 73.  
 Flintham, 136.  
 Flower, 121.  
**FLOWER, 121, 122.**  
 Alice, 122.  
 Alice (Harington), 143.  
 Cassandra (Braddock), 121.  
 Catherin (Chaworth), 122,  
 128.  
 Dorathey, 122.  
 Edward, 122.  
 Elizabeth, 122.  
 Elizabeth (Hartop), 92, 122.  
 Elizabeth (Digby), 122.  
 Ellinor (Meering), 121.  
 Francis, 122.  
 George, 92, 122.  
 Grace, 122.  
 Henery, 121, 122.  
 John, 121, 122.  
 Mary, 122.  
 Mary (Eyre), 122.  
 Mary (Sacheverell), 122.  
 Randolfe, 122.  
 Thomas, 121, 122, 128.  
 Ursula (Huning), 122.  
 Ursula, 122.  
 Flowerden, —, 62.  
 Fly, Allicia, 6.  
 Foliamb, Catherin, 187.  
 Sir Godfry, 187.  
 Issabell, 146.  
 Foliambe, Alice, 171.  
 Bennett, 160.  
 Godfry, 171.  
 Sir Godfrey, 160.  
 Foljamb, 16.

- Folliaamb, Thomas, 73.  
 Anne (Harrington), 73.  
 Fone, Lucia, 19.  
 Sewallus le, 19.  
 Fones, Ester, 92.  
 Hester, 183.  
 John, 92, 183.  
 Forestarius, Brianus, 79.  
 Henricus, 79.  
 Forester, Brian (the), 79.  
 Forster, Anne (Goodere), 175.  
 Anthony, 38.  
 Christian (Dabridgcourt), 38.  
 Henery, 155.  
 Lucy (Chaworth), 128.  
 Thomas, 128, 155.  
 forster, Anne (Mering), 13.  
 Gyles, 13.  
 Fosbrok, Geraldus, 53.  
 Foster, Ann (Moting), 74.  
 Elizab. (North), 82.  
 Thomas, 82.  
 Fort, Galfridus de, 52.  
 Fotherby, — (Nevell), 65.  
 foune, Elizabeth, 12.  
 John, 12.  
 Peter, 12.  
 fowlerherst, Margery, 9.  
 Sir Robert, 9.  
 Fox, George, 106.  
 Henery, 173.  
 Margaret (Wase), 173.  
 Winifrid, 106.  
 —, 158.  
*Francis*, 117.  
 Francis, Anne, 164.  
 Elizabeth (Sachoverell), 164.  
 Elizabeth (Babington), 151.  
 Jane, 117.  
 Raffe, 151, 164.  
 Richard, 113, 164.  
 Robert, 117.  
 Ursula, 113.  
 francis, Isabell, 17.  
 Sir Robert, 17.  
 Franck, fraunces, 56.  
 Joane, 133.  
 Thomas, 133.  
 Sir William, 55, 56.  
 — (Tunstall), 55, 56.  
 Franke, Elizabeth, 187.  
 freeman, William, 2.  
 Frensb, Elizabeth, 151.  
 Walter, 151.  
 Freschevile, Ankerus, 48, 50.  
 Issabella, 48, 50.  
 Margaret (Monbocher), 48,  
 50.  
 Sir Raffe, 50.  
 Sir Radulphus, 48.  
 Fretchvile, Frances, 63.  
 John, 71.  
 Issabell (Nevell), 60.  
 Jonnett, 66.  
 Joyce (fleetwood), 31.  
 Millescent (Lascells), 59;  
 Raffe, 59.  
 Peter, 63.  
 Sir Peter, 31, 66.  
 fretchvile, Elizab. (Clifton), 18.  
 Sir Peter, 31.  
 Peter, 61.  
 Frevile, Sir Baldwin, 146.  
 Margaret, 146.  
 Frevill, Baldwinus, 121.  
 Margeret, 121.  
 Friskney, William, 33.  
 Margerett (Bretofte), 33.  
 Friule, John, 46.  
 Frowick, Allice, 175.  
 Thomas, 175.  
 Froxmore, Thomas, 161.  
 Catherin (Cornwallis), 161.  
 Fuller, Allice, 158.  
 Mathew, 158.  
 Fullwood, John, 38.  
 Catherin (Dabridgcourt), 38.  
 fulwood, Margaret, 28.  
 Robert, 28.  
 Fyn, Allice, 58.  
 William, 58.  
 Gabbott, Elizabeth, 28.  
 Robert, 28.  
 Gage, Margerett, 91.  
 Gainsburgh, Ric. de, 46.  
 Galle, —, 137.  
 Galloway, Allan, Lord of, 111.  
 Garneys, Elizabeth, 21.  
 Thomas, 21.  
 Garnishe, Elizabeth, 21.  
 Thomas, 21.  
*Garnon*, 135.  
 GARNON, 135.  
 Allice (Marshall), 135, 166.  
 Allice (Robinson), 135.  
 Andrew, 135, 166.  
 Anne (Crosley), 135.  
 Catherin, 135.  
 Catherin (Swyneborne), 135.  
 Edward, 135.  
 Elizabeth, 135.  
 Henery, 135.  
 Issabell, 135.  
 John, 135.  
 Mary, 135.  
 William, 135.  
 Garton, Elizabeth, 137.  
 Frances, 137.  
 Gascoigne, Jane, 174.  
 William, 174.  
 Gasteneys [*i. e.* Wastnes], 67, 68.  
*Gasteneys* [and seal], 67.  
 Gasteneys, Ampelisia (Morley),  
 67.  
 Batreia (—?), 67.  
 Constantia (—?), 68.  
 Sir Hardolphe, 67.  
 Issabell (Hay), 68.  
 Joane (Brett), 68.  
 Joanne (Toly), 68.  
 Johanna de (—?), 67.  
 Johannes de, 67.  
 John, 68.  
 Sir John, 68.  
 Margerett (—?), 68.  
 Sir Phillipe, 67.  
 Rananilda (—?), 67.  
 Sir Robert, 67.  
 Thomas de, 67.  
 Thomas, 68.  
 Thomazin, 68.  
 William, 68.  
 Sir William, 68.  
 Gastneis, Edmond, 67.  
 Gastneys, Edmond, 67.  
 Sir Edmond, 67.  
 John, 67.  
 Sir William, 67.  
 Gate, Allice, 94.  
 Lucey (Benington), 94.  
 Richard, 94.  
 Gaunt, Walter de, 51.  
 Gawyn, Anne (Delamare), 38.  
 William, 38.  
 Gedney, John, 143.  
 Olive (Sutton), 143.  
 Gell, Anne, 100.  
 Edward, 100.  
 Gelsthorp, John, 28.  
 Mary (Trussell), 28.  
 Gelthorpe, Anne (Baker), 36.  
 Francis, 36.  
 Germin, Edward, 74.  
 Fayth (Mollineux), 74.  
 Gerrard, Sir Thomas, 7.  
 Elizabeth (Port), 7.  
 Gibson, Anthony, 36.  
 Ann (Samon), 36.  
 —, 77.  
 Gibson, John, 79.  
 Barbara (St. Andrew), 79.  
 Edmond, 89.  
 Joane (Bland), 89.  
*Gifford*, 179.  
 Gifford, Elizabeth, 7.  
 Sir John, 179.  
 Thomas, 7.  
 Gilbert, Edward, 149.  
 Elizabeth, 83, 149.  
 Sir John, 83.  
*Gilliott*, 166.  
 Glover, Robt. [Somerset He-  
 rald], 129.  
 Godfrey, Anne, 147.  
 Mary, 107.  
 Richard, 107, 147.  
*Godsalve*, 99.  
 Godsalve, Elizabeth, 99.  
 Thomas, 99.  
*Golding*, 107.  
 GOLDING, 107.  
 Edward, 107.  
 Ellinor (Throgmorton), 107.  
 Frances, 107.  
 John, 107.  
 Mary, 107.  
 Mary (Godfrey), 107.  
 Merabell (Aldham), 107.  
 Goldwell, Catherin, 185.  
 Stephen, 185.  
 Golesborough, Thomas, 127.  
 Joanne (Chaworth), 127.  
 Goleyngton, John, 126.  
 Joyce (Engayne), 126.  
 Katherin, 126.  
 Thomas, 126.  
 Goneston, Anne (Hunt), 167.  
 Gonson, Benjamin, 34.  
 Thomazin, 34.  
 Good, Robert, 3.  
 Goodall, Elizabeth, 139.  
 Robert, 139.  
 Gooder, Sir Francis, 175.  
*Goodere*, 175.  
 GOODERE, 175, 176.

GOODERE—*continued*.

Alice (Brent), 175.  
 Allice (Frowicke), 175.  
 Anne, 175, 176.  
 Anne (Cooke), 176.  
 Audrey (Rombold), 176.  
 Catherin (Onslow), 176.  
 Dorathy, 175.  
 Francis, 176.  
 Sir Francis [Gooder], 175.  
 Henry, 175, 176.  
 Jane, 176.  
 Jane (Lewknor), 175.  
 Jane (Greene), 176.  
 Jane (Hawte), 175.  
 John, 175.  
 Judith, 176.  
 Lucy, 176.  
 Margerott, 175.  
 Margeret (Daberne), 175.  
 Richard, 175.  
 Scisseley, 175.  
 Susanna, 175.  
 Thomas, 175, 176.  
 Ursula, 176.  
 William, 175, 176.  
 — (Thornbury), 175.  
 — (Saunders), 175.  
 Goodericke, Anne, 94, 174.  
 Henry, 174.  
 Goodwin, Edward, 134.  
 Elizabeth, 134.  
 Gosling, Elizabeth, 154.  
 Richard, 154.  
 Goughe, Barnaby, 91.  
 Mary (Darrell), 91.  
 Goulson, Margerett, 137.  
*Goulston*, 136.  
 Gourney, Constance, 99.  
 Joane (Roos), 112.  
 Thomas, 112.  
 Gowland, John, 119.  
 Graa, Sir John, 44, 45.  
 Margt. (Swillington), 44, 45.  
 Grandison, Vist. [St. John], 60.  
 Grantham, Francis, 116.  
 Jane (Hutchinson), 116.  
 Margaret, 106.  
 Mary (Donham), 160.  
 Thomas, 160.  
 Vincent, 106.  
 Graunt, Mary, 168.  
 Thomas, 158.  
 Gray, Agnes, 17.  
 Elizabeth (Bassett), 42.  
 Joane, 145.  
 Lord, 145.  
 Richard Lord G. [of Condor], 42.  
 Lord [of Wilton], 17.  
 Greene, Dame Marine, 54, 55, 58.  
 Elizabeth, 58, 132.  
 Ellen, 169.  
 Francis (Darrell), 91.  
 Jane, 175.  
 Joane (Vawdy), 87.  
 Margaret, 137.  
 Marian (Bellers), 58.  
 Thomas, 87, 132, 169.  
 Sir Thomas, 58.  
 Greenhaugh, Elizabeth, 73.

Greenhaugh—*continued*.

Roger, 73.  
 Gregory, William, 2.  
*Grenould*, 189.  
 Gresley, Ellen, 21.  
 Sir John, 90.  
 Sir Nicholas, 68.  
 Sir Thomas, 21.  
 Thomazin (Gasteneys), 68.  
 Thomazin, 90.  
 Grey, Agnes, 78.  
 Anne, 148, 149.  
 Catherin, 58.  
 Elizebeth [illegitimate], 164.  
 Elizabeth (Basset), 139.  
 Sir Edmond, 148.  
 Sir Edward, 148.  
 Henry, Lord, 164.  
 Jeromy, 43.  
 Sir Richard, 78.  
 Richard, Lord, 138.  
 Susanna (Dod), 43.  
 Thomas, 149.  
 Sir Thomas, 58.  
 [Viscount Lisley, *i. e.* L'Isle], 148.  
 [Marquis of Dorset], 149.  
 Grice, —, 41.  
 Griffin, Mary, 24.  
 Sir Richard, 24.  
 Sir Thomas, 24.  
 Griffith, Ann, 17.  
 Anne (Constable), 17.  
 Sir John, 147.  
 Margaret, 147.  
 Sir Walter, 17.  
 Griketell, Thomas, 52.  
 Grimesby, Anne, 139.  
 Anne (Moton), 138.  
 Thomas, 138.  
 William, 138.  
 — (Harecourt), 138.  
 Grimston, Charles, 162.  
 Edmond, 162.  
 Mary, 162.  
 Griswold, Allice, 38.  
 John, 38.  
 Richard, 38.  
 Grosvenor, Jane, 62.  
 Guildeford, Anne, 90.  
 Edward, 90.  
 Gunston, Jane, 160.  
 Sir Thomas, 160.  
 —, 136.  
*Gunthorpe*, 189.  
 Gunthorpe, Thomas, 189.  
 Guppie, Margerett, 156.  
 William, 156.  
 Hablethorne, Joane (Cressy), 95.  
 Hacker, Elizabeth, 132.  
 John, 132.  
*Hackett*, 188.  
 Sir Walter, 50, 188.  
 Haddon, Anne (Sutton), 144.  
 Walter, 144.  
 Hadock, Gilbert, 72.  
 Joane, 72.  
 Haghett, Bertram, 51.  
 Halgh, George, 9.  
 Elizabeth (Casterden), 9.  
 Hall, 143.

Hall, Alice, 143.  
 Francis, 143.  
 Elizebeth, 132.  
 Margerett, 41.  
 Thomas, 106.  
 Ursula, 106.  
 William, 132.  
 —, 13.  
 —, 41.  
 —, 114.  
 Halswell, Mary, 156.  
 Nicholas, 156.  
 Hamerton, — (Elwis), 30.  
 Hampsterley, Joane, 181.  
 Elizabeth (Stanton), 180.  
 Hamond, 181.  
 Robert, 181.  
 William, 180, 181.  
 Handforth, John, 115.  
 Margerett, 115.  
*Handley*, 156.  
 HANDLEY, 156, 157.  
 Allice, 157.  
 Allice (Bray), 157.  
 Anne, 157.  
 Ann (Brand), 157.  
 Anne (Charlton), 157.  
 Catherin, 157.  
 Gervase, 157.  
 Henry, 157.  
 Huntington, 157.  
 Margaret, 157.  
 Mary, 157.  
 Richard, 157.  
 Robert, 157.  
 Winiffrid, 157.  
 — (Fitz Williams), 157.  
 —, 156.  
 Hanforth, John, 115.  
 Margerett, 115.  
 Hanney, William, 46.  
*Hansard*, 161.  
 Hansard, Elizabeth, 77.  
 Jane, 41, 161.  
 William, 77, 161.  
 Harbottel, Richard, 148.  
 Jane (Willoughby), 148.  
 Harcourt, Jane, 20.  
 Harden, William, 66.  
 Elizabeth (Nevell), 66.  
 Harding, William, 83.  
 Helen, 83.  
 Hare, Ann, 187.  
 Issabell, 65.  
 John, 65.  
 Richard, 2.  
 Harecourt, Agnes, 20.  
 Thomas, 28.  
 Ursula (Trussell), 28.  
 —, 138.  
 Harington, Anne, 73.  
 Allice (Stolehill), 171.  
 Bridgett, 26.  
 Ellen, 72.  
 Issabell (Markham), 24.  
 Sir James, 24, 73.  
 John, 24.  
 Sir William, 72.  
*Harison*, 189.  
 Harison, John, 189.  
 Harman, Elizabeth, 129.  
 Hugh, 129.

- Harmer, John, 28.  
   Elizabeth (Trussell), 28.  
 Harper, Dorathey, 96.  
   Issabell (Nevell), 66.  
   Sir John, 96.  
   Sir Richard, 66.  
*Harrington*, 188.  
 Harrington, Allice, 143.  
   Barbara (Sutton), 143.  
   Elizabeth (Moton), 139.  
   Francis, 143.  
   Sir James, 139.  
   Sir John de, 188.  
   John, Lord, 139.  
   Sir John, 139, 143.  
   Lord Stanhop of, 8.  
 Harris, Ellen, 114.  
   Elizabeth, 51.  
   Sir Thomas, 51.  
 Harrison, Ann (Clarkson), 92.  
 Harrison, —, 41.  
   Anne (Claxton), 183.  
 Harrisonn, George, 114.  
   Elizabeth (Southworth), 114.  
 Harston, Anthony, 112.  
   Ellen (Ross), 112.  
 Harte, Catherin, 185.  
   Sir Percivall, 185.  
 Harteshorne, Catherin, 24.  
   William, 24.  
 Hartop, Elizabeth, 92.  
   Mary, 85.  
   Valentine, 85.  
   William, 92.  
   —, 183.  
 Harvey, frances, 31.  
   James, 31.  
   Joane, 153.  
   Thomas, 153.  
 Harvey, Agnes, 111.  
   Sir James, 111.  
 Harwood, 43.  
 Haselam, Christopher, 3.  
*Haselrig*, 153.  
 HASELRIG, 153.  
   Anne (Stotehill), 172.  
   Bertram, 172.  
   Catherin, 153.  
   Donald, 153.  
   Dorathe, 153.  
   Elizabeth, 153.  
   Elizabeth (Stanton), 153.  
   Ellenor (Shirley), 153.  
   Francis, 153.  
   Hugh, 153.  
   Issabell, 153.  
   Joane (Harvey), 153.  
   John, 153.  
   Lucy (Entwesell), 153.  
   Michell, 153.  
   Robert, 153.  
   Simon, 153.  
   Thomas, 153.  
   William, 153.  
   — (Brockett), 153.  
   — (Essington), 153.  
 Haselwood, Ann, 108.  
   Frances (Donham), 160.  
   John, 160.  
   Thomas, 108.  
 Haslake, —, 158.  
*Hassall*, 169.  
 Hassall, Agnes, 169.  
   Robert, 169.  
*Hastings*, 163, 188.  
 Hastings, Dorathey (Port), 7.  
   Catherin, 8.  
   Dorathey (Willoughby), 149.  
   Ed. Lord [Hungerford], 163.  
   ffrancis, 8.  
   Henery, 8, 149.  
   Sir George [E. of Hunting-  
   ton], 149.  
   [E. of Huntington], 7, 8.  
   Sir Nicholas de, 188.  
 Hasty, Sir Henry [note], 142.  
   Katherin [note], 142.  
*Hatfeilde*, 189.  
 Hatfeld, Anne (Hercye), 117.  
   Barbara, 118.  
   Elizabeth, 118.  
   Henery, 117.  
   Issabell (Marshall), 166.  
   Laurence, 166.  
*Hatfield*, 117.  
 Hatfield, Agnes, 70.  
   Allice (Hercye), 15.  
   Catherin (Molineux), 72.  
   Elizabeth (Molineux), 72.  
   Henry, 15.  
   Lawrance, 15.  
   Stephen, 72.  
 Hatfeld, —, 139.  
*Haversham*, 145.  
 Hawke [note], 91, 97.  
*Hawkes*, 166.  
 Hawkes, Jennett, 166.  
   Margerett, 166.  
   Walter, 166.  
   William, 166.  
 Hawkis, Walter, 166.  
 Hawkesworth, Catheren (Go-  
 leyngton), 126.  
   Thomas, 126.  
 Hawley, John, 8.  
   Mary, 8.  
 Hawslyn [note], 119.  
 Hawto, Jane, 175.  
   Sir Thomas, 175.  
 Hay, Isabell, 68.  
   Jeromy, 68.  
 Heard, Allice (Roos), 112.  
   John, 112.  
 Hebbs, Elizabeth, 30.  
   Roger, 30.  
 Hed, John, 161.  
   Dorathey (Cornwallia), 161.  
 Hedley, —, 91.  
 Helwis, Sir Jervis [note], 30.  
 Helwish, al's Elwia, 29.  
 Henage, Sir George, 62.  
 Heningham, Anne, 24.  
   George, 24.  
 Henson, Allice, 134.  
   Gregory, 134.  
*Hercye*, 12, 14, 64.  
 HERCYE, 14, 15.  
   Allice, 15.  
   Anne, 15, 117.  
   Barbara, 15, 65.  
   Catherin, 13, 15.  
   Catherine (Comberford), 14.  
   Elizabeth, 20.  
   Elizabeth (Leek), 14.  
*HERCYE—continued.*  
   Elizabeth (Stanhop), 6.  
   Elizabeth (Digby), 15.  
   Elizabeth (Stanley), 15.  
   Ellen, 15.  
   Hugh, 14, 15.  
   Sir Hugh, 14.  
   Humffrey, 6, 13, 15, 117.  
   Jane, 15.  
   Jane (Stanhope), 15.  
   Sir John, 12, 14, 15, 20, 65.  
   Sir Lawrance, 14.  
   Malvoisine de, 14.  
   Sir Malvoisine, 14.  
   Margery (Bingham), 15.  
   Mary, 15.  
   Maud, 12.  
   Robert, 14.  
   Swanius, 14.  
   Theophania (Arches), 14.  
   Theodania (Arches), 14.  
   Sir Thomas, 14.  
   Ursula, 15.  
   William, 14.  
   — (Hevize), 14.  
 Herenden, al's Arundell, 35.  
   Edward, 35.  
   Myllesent (Samon), 35.  
 Hering, Richard, 3.  
 Heriz, Joane, 124.  
   Sir Johannes, 44, 48.  
   Sir John, 56.  
   Maud (Bassett), 124.  
   Sara, 44, 48, 56.  
   William, 124.  
*Herize*, 44.  
   John, 14.  
   Sir John, 44.  
 Herriz, 49, 123.  
 Herris, Jane, 50.  
   Anne (Scennermarsh), 49.  
   Henery, 49, 50.  
   Joane (Lowdham), 49.  
   Margaret (Nevell), 50.  
   Margerett (Bussy), 49.  
   Sir Morris, 49.  
   Richard, 50.  
   Sir Richard, 49.  
   Robert, 50.  
   Thomas, 50.  
   William, 50.  
*Herle*, 74.  
 Herle, John, 74.  
   Etheldred, 74.  
 HERON, 182, 183.  
   Anne, 183.  
   Catherine (Sherbrooke), 183.  
   Cecily (Moore), 183.  
   Christopher, 183.  
   Edmond, 88, 183.  
   Edward, 73.  
   Elizabeth (Roper), 182.  
   Giles, 183.  
   Henery, 183.  
   Jenkin, 183.  
   John, 182.  
   Sir John, 182.  
   Margerett (Ridley), 182.  
   Margerett (Wood), 88, 183.  
   Samwell, 183.  
   Theodosia, 73.  
   Thomas, 183.

**HERON—continued.**

William, 182.  
 Hesull, Elizabeth, 86.  
 Herthull, 188.  
 Herthull, Sir Richard de, 188.  
 Hertley, 188.  
 Hetley, 188.  
 Heton, 188.  
 Hewett, Alice, 31.  
 Sir William, 31.  
 Hewson, 87.  
 Hewson, Catherin, 87.  
 William, 87.  
 Hewstas, Anne, 177.  
 Thomas, 177.  
 Heyfield, —, 58.  
 Heyton, 107.  
 Heyton, Margerett, 107.  
 Richard, 107.  
 Hill, John, 21.  
 Alice (Bayley), 173.  
 Judith, 21.  
 William, 173.  
 — (Babington), 151.  
 Hilton, Anne, 87.  
 Baron, 147.  
 Baron [in note], 87.  
 Dorathey, 40.  
 Mary, 87.  
 William, 87.  
 Sir William, 40.  
 — (Willoughby), 147.  
 Hinton, 103.  
 Hinton, Anne, 103.  
 Griffith, 103.  
 Hoding, Radulphus de, 53.  
 Holcombe, Elizabeth, 152.  
 Holcroft, Eliz. (Reyner), 56.  
 Elizabeth (Filton), 56.  
 Mary (Talbot), 56.  
 Thomas, 56.  
 Sir Thomas, 56.  
 Holdenby, Robert, 172.  
 Barbara [Bevercotts], 172.  
 Holland, 190.  
 Holland, Richard, 22.  
 Mary (Strelly), 22.  
 Hollis, 61.  
**HOLLIS**, 61, 62, 63.  
 Anne, 62, 63.  
 Anne (Doynsyll), 61, 62.  
 Anne (Densill), 62.  
 Anne (Stanhop), 7, 62.  
 Anne (Lany), 63.  
 Arabella, 63.  
 Christopher, 62.  
 Darcy, 63.  
 Densill, 62, 63.  
 Dorathey (Lacon), 62.  
 Edward, 62.  
 Elizabeth, 63.  
 Elizabeth (Scopham), 62.  
 Elizabeth (Kingstone), 63.  
 Ellinor, 63.  
 Ellinor (Sheaffeld), 63.  
 Frances, 62.  
 Francis, 62, 63.  
 Frances (Fretchville), 63.  
 Fretchville, 63.  
 Sir George, 62.  
 Gervase, 63.  
 Sir Gervase, 63.

**HOLLIS—continued.**

Gertrude, 62, 63.  
 Sir Hugh, 61.  
 Jane, 62.  
 Jane (Grosvenor), 62.  
 John, 7, 61, 62, 63.  
 Sir John, 7, 62, 63.  
 Sir John [Lord Houghton  
 E. of Clare], 7.  
 Margery, 61.  
 Magerett, 63.  
 Richard, 61.  
 Samwell, 63.  
 Thomas, 61, 62.  
 Sir Thomas, 62.  
 William, 61, 62, 63.  
 Sir William, 62.  
 — (Flowerden), 62.  
 — (Henage), 62.  
 — (Payne), 62.  
 Holme, Joane, 57.  
 Issabell (Samon), 35.  
 John, 28, 57.  
 Mary (Trussell), 28.  
 William, 35.  
 Holmes, Elizabeth, 134.  
 Geffry, 140.  
 James, 134.  
 Holt, Agnes, 172.  
 Robert, 172.  
 Holttofte, 103.  
**HOLTOFFE**, 103.  
 Alexander, 103.  
 Anne, 103.  
 Anne (North), 103.  
 Elizabeth, 103.  
 Elizabeth (Whitmore), 103.  
 Robert, 103.  
 Walter, 103.  
 Homberston, Raffe, 105.  
 Ursula, 105.  
 Homespeirpoint, Barron of  
 [Perpoint], 57.  
 Homfroyville, 77.  
 Hooks, Anne, 27.  
 Hugh, 27.  
 Hopton, —, 104.  
 Horbury, Sir John, 67.  
 Horne, 90.  
 Horne, Elizabeth, 90.  
 James, 90.  
 Horsey, Anne (Heron), 183.  
 Horsley, Anne (Heron), 183.  
 Horssey, Anne, 118.  
 George, 118.  
 Horstaff, George, 190.  
 Hotham, Sir Francis, 15.  
 John, 8.  
 Juliana (Stanhop), 8.  
 Mary (Hercy), 15.  
 Houndgate, —, 40.  
 Howby, Alicia, 53.  
 Alice, 58.  
 Anktirus, 53.  
 Anthony, 52, 58.  
 Anthony de, 58.  
 Elizabeth, 52, 53, 58.  
 Gilbert, 53.  
 Gilbert de, 58.  
 Walter, 53.  
 Walter de, 58.  
 Howell, Elizabeth, 118.

**Howell—continued.**

William, 118.  
 Howson, William, 77.  
 Elizabeth (Ayscough), 77.  
 Hoxton, Ann (Sotehill), 171.  
 Huddleston, Margarett, 36.  
 Hudleston, John, 127.  
 Hudson, Robert, 4.  
 Huevingham, Agnes (Long-  
 villers), 5.  
 Reignal, 5.  
 Hugford, Henry, 38.  
 Ann (Dabridgcourt), 38.  
 John, 38.  
 Hulme, 48.  
 Hulme, James, 48.  
 Leonius, 48.  
 Micheall, 48.  
 Michell, 48.  
 Walter de, 48.  
 Humphry, Thomas, 13.  
 Mary (Mering), 13.  
 Hun, Frances, 146.  
 Henry, 146.  
 Hungerford, Edward, 163.  
 [Lord Hastings], 163.  
 Mary (— ?—), 163.  
 Huning, Henry, 122.  
 Ursula, 122.  
 Hunings, 121.  
 Hunings, Catherin, 174.  
 Edward, 174.  
**HUNT**, 167.  
 Anne, 167.  
 Catherin, 167.  
 Dorathey (Clarkson), 167.  
 Edmond, 167.  
 Henry, 167.  
 Issabell, 167.  
 Issabell (Marshall), 166,  
 167.  
 Jane, 167.  
 Joane, 20.  
 John, 20.  
 Thomas, 166, 167.  
 Hurt, Richard, 2.  
 Hussey, 136, 142.  
 Hussey, Anne, 137.  
 Henry, 136,  
 Sir Hugh, 136, 142.  
 John, 136, 137.  
 Margerett, 142.  
 Robert, 142.  
 — (Baker), 137.  
 — (Methley), 136.  
 — (Revell), 137.  
 — (Staunton), 136.  
 Hussey, James, 180.  
 John, 36.  
 Elizabeth (Bellers), 36.  
 — (Bellers), 180.  
 Hussey, 179.  
 Hutchinson, 115.  
**HUTCHINSON**, 115, 116.  
 Anne, 116.  
 Catherin, 116.  
 Elizabeth, 71.  
 George, 116.  
 Jane, 116.  
 Jane (Sacheverell), 116.  
 John, 115, 116.  
 Margerett (Byron), 116.

- HUTCHINSON**—*continued*.  
 Mary, 116.  
 Mary, Byron, 10.  
 Thomas, 10, 41, 71, 115, 116.  
 — (Perpoint), 116.  
 — (Souch), 116.  
 — (Watsonn), 115  
**Hyde**, —, 36, 76.  
**Hynd**, Anne, 130.  
 Anne (Lyon), 127.  
 Andrew, 130.  
 Augustin, 129, 173.  
 Edward, 172, 130.  
 Elizabeth, 129, 130.  
 Elizabeth (Bevercotts), 172.  
 Elizabeth (Wase), 173.  
 Elizabeth (Drury), 130.  
 Henery, 129.  
 John, 130.  
 Richard, 129.  
 Robert, 129.  
 Rowland, 129.  
 William, 129.  
 — (Glover), 129.  
*Hynde*, 122.  
**HYNDE**, 129, 130.  
 Augustin, 129.  
 Elizabeth (Lee), 129.  
 Ellin, 120.  
 Joane, 129.  
  
*Illingworth*, 84, 188.  
 Illingworth, —, 85.  
 Ingleby, George, 155.  
 Elizabeth (Bingley), 155.  
 Inglefeld, Elizabeth (Bruse),  
 166.  
 Richard, 166.  
*Inglos*, 99.  
 Inglos, Elizabeth, 99.  
 Ingoldesby, Mary (Blondeston),  
 158.  
 Insula, Gaufridus de, 52.  
 Ireland, George, 118.  
 Margaret, 118.  
 Isham, Edward, 160.  
 Mary, 160.  
 Ithell, Catherin, 28.  
 Ivangrch, David ap, 37.  
 Jannett, ap, 37.  
  
*Jackson*, 70.  
 Jackson, Jane, 70.  
 Elizabeth (Savill), 70.  
 Elizabeth (Thornhegh), 70.  
 Sir John, 70.  
 Jackson, Arther, 2.  
 Barbara (Clifton), 18.  
 William, 18.  
 Jek, Ivo, 20.  
 Helen (Strolley), 20.  
 Jenkinson, John, 106.  
 Theodocia (Yerburgh), 106.  
 Jenny, Margerett, 180.  
 William, 184.  
 Jennyson, Thomas, 3.  
*Jenyson*, 95.  
 Jenyson, Margerett, 95.  
 Thomas, 95.  
 Jepsay, —, 158.  
 — (Fox), 158.  
 Japson, John, 4.
- Jermin, Elisabeth, 66.  
 John, 66.  
 Jernegan, Anne, 161.  
 John, 161.  
 Jerningham, Margareta, 6.  
**JESSOP**, 94.  
 Anne, 94.  
 Anne (Swifte), 94.  
 Anne (Gooderick), 94.  
 Catherin (Doyley), 94.  
 George, 94.  
 Margerett, 94, 156.  
 Margerett (Atherton), 94.  
 Richard, 94, 156.  
 Wortelly, 94.  
 William, 94.  
 Jobson, Ann, 85.  
 Thomas, 85.  
 Johnson, Elizabeth, 65.  
 Mary (Willoughby), 147.  
 William, 147.  
 Johnston, Mary (Darrell), 91.  
 William, 91.  
 Jopesay, —, 158.  
 — (Fox), 158.  
  
 Katherynes, Dorathey, 99.  
 Humfrey, 99.  
*Kaynes*, 123, 125.  
*Kaynes, Caignes al's*, 125.  
 Kaynes, John, 125.  
 Luke, 125.  
 Margerett, 125.  
 Robert, 125.  
 William, 125.  
*Kelk*, 121.  
 Kemp [Cardinal], 20.  
 Issabell, 20.  
 John, 20.  
 John [Abp. of Cant.], 20.  
 Thomas, 20.  
 Kempster, Giles, 28.  
 Scissely (Trussell), 28.  
 Kent, Elizabeth, Countess of  
 (Wake), 37.  
 John, E. of (Plantagenet), 37.  
 Ketlewood, Sara, 28.  
 Kettleby, —, 136.  
 Key, Peter, 3.  
 Kighley, Jane, 119.  
 Robert, 119.  
 Kilborne, Francis, 190.  
*Kilpeck*, 145.  
 Kingston, E. of [note], 49.  
 Kingston-upon-Hull, E. of, 56.  
 Kingstone, Elizabeth, 63.  
 John, 63.  
 Kirby, Agnes, 164.  
 Richard, 164.  
 Kirchener, Hugh, 190.  
 Kirkby, —, 140.  
 Kirnsale, John, 47.  
 Richard, 47.  
*Kirton*, 117.  
 Kirton, Alice, 180.  
 Sir Robert, 180.  
 Kitson, Sir Thomas, 162.  
 Elizebeth (Cornwallis), 162.  
 Knapwell, Will de, 79.  
 Knifton, Mary, 128.  
 Thomas, 128.  
 Sir William, 128.
- Knight**, Jane (Wightman), 178.  
 William, 178.  
 —, 147.  
 Knivell, Hellen (Harding), 83.  
 Mary, 83.  
 Richard, 83.  
 Kniveton, Agnes (Elwis), 29.  
 Ellen, 89.  
 —, 89.  
*Knotsworth*, 90.  
 Knotsworth, Jane, 90.  
 William, 90.  
 Knowles, Elizabeth, 146.  
 Henery, 146.  
 William, 8.  
 Knowles, Emme, 151.  
 Sir Robert, 151.  
*Kyme*, 77.  
 Kyme, Bridgett, 105.  
 Sir Phillip, 105.  
 Kynaston, Anne, 43.  
 Thomas, 43.  
  
 Lacella, Roger de, 52.  
*Lacock*, 95.  
**LACOCK**, 95, 96, 190.  
 Alice (Widowson), 96.  
 Edmond, 96.  
 George, 96.  
 Leonard, 95.  
 Margaret (Jenyson), 95.  
 Mathew, 96.  
 Phillip, 96.  
 Thomas, 96.  
 — (Cartright), 96.  
 Lacon, Anne (Blondeston), 158.  
 Dorathey, 63.  
 Harbert, 158.  
 Herbert, 63, 101.  
 Susan, 101.  
 Lacye, Alice, 71.  
 John, 71.  
 Lane, Roger, 26.  
*Langford*, 188.  
 Langford, Ellen, 55, 56.  
 Sir John de, 188.  
 Sir Nicholas, 55, 56.  
*Langford*, 50.  
 Langford, Sir John, 50.  
 Margaret, 50.  
 Margerett (Markham), 25.  
 Nicholas, 25.  
 Langham, —, 13.  
 Langley, Elizabeth, 163.  
 Robert, 163.  
 Langstone, Amye, 173.  
 Langton, Cuthbert, 187.  
 Jane, 187.  
 Joane, 187.  
 Johanna, 187.  
 William de, 45.  
 Lany, Anne, 63.  
 William, 63.  
*Lascells*, 53 [seal], 57.  
**LASCELLS** (Llascells), 57, 58,  
 59, 60.  
 Agnes (Roccliff), 58.  
 Alice, 58.  
 Alice (Fyn), 58.  
 Anne, 56, 60, 74.  
 Ann (Skipwith), 57.  
 Anne (—?—), 59.

LASCHELLS—*continued.*

Anne (Wirral), 60.  
 Avico, 57, 58.  
 Bryan, 59.  
 Sir Bryan, 59.  
 Catherin, 57, 59.  
 Catherin (Grey), 58.  
 Christiana (Lomington), 53.  
 Christopher, 59.  
 Digby, 59.  
 Dorathey, 59.  
 Dorathey (Sandford), 58.  
 Dorathey (Paynell), 59.  
 Duncanus de, 53.  
 Edmond, 60.  
 Edmundus de, 52.  
 Edward, 58.  
 Elizabeth, 42, 57, 59, 60.  
 Elizabeth (Delamore), 57.  
 Elizabeth (Marbury), 59.  
 Ellen, 60.  
 Ellen (Beckwith), 58.  
 Ellinor, 59.  
 Ellinor (Wandisford), 59.  
 Francis, 59.  
 George, 42, 52, 58, 59, 73, 74.  
 Sir George, 59.  
 Galfrey, 51, 57.  
 Galfridus de, 57.  
 Gaufridus de, 51, 53.  
 Sir Geffery, 57.  
 Gervase, 59, 60.  
 Helen, 57.  
 Henry, 58, 59.  
 Hercye, 59.  
 Issabell, 57.  
 Issabell (Wooderington), 58.  
 Issabell (Mountague), 59.  
 Jane (Mallory), 60.  
 Jane (Mollineux), 74.  
 Joane, 57, 58.  
 Joane (Topcliff), 58.  
 John, 57, 58, 59, 60.  
 Sir John, 57.  
 Johannes de, 51, 52.  
 Lionell, 60.  
 Margaret, 57, 58, 60.  
 Mary, 59.  
 Matilda de, 51.  
 Maud, 58.  
 Maud (—?—), 57.  
 Maud (Constable) 57.  
 Milliscent, 59.  
 Picott, 57.  
 Picotus de, 51, 57.  
 Radulphus de, 53.  
 Raffe, 58, 59.  
 Sir Raffe, 57, 58.  
 Richard, 57, 58, 59.  
 Sir Richard, 57.  
 Richard de, 58.  
 Robert, 58.  
 Robertus de, 52.  
 Roger, 59.  
 Roger de, 57.  
 Sir Rogerus de, 53.  
 Sir Roger, 59.  
 Samwell, 59.  
 Sara de, 51.  
 Scisseley (Danby), 58.  
 Susan, 59.  
 Theophania, 50 60.

LASCHELLS—*continued.*

Thomas, 59, 60.  
 Sir Thomas, 57.  
 Walter, 57, 58.  
 Walterus de, 53.  
 Sir Walter, 58.  
 William, 57, 58, 60.  
 Williamus de, 51, 52.  
 Winifrid, 59.  
 — (Eland), 58.  
 — (Medcalffe), 58.  
 — (Heyfield), 58.  
 — (Sodgwick), 59.  
 — (Thwaites), 59.  
 Lattimer, John Lord, 162.  
 Lucy, 162.  
 Leak, Sir Francis, 25.  
 Leake, 14, 64 [in note], 117.  
 Leake, Sir Francis, 18.  
 Mary (Egioke), 18.  
 Lee, Sir James, 15.  
 Elizab. (Stanley), 15.  
 Elizabeth, 129.  
 Sir Richard, 129.  
 Jeffrey [note], 100.  
 Leech, Anne, 163.  
 Sir Edward, 128.  
 — (Chaworth), 128.  
 Elizabeth, 104.  
 Sir Robert, 163.  
 Sir Roger, 163.  
 Ursula, 105.  
 William, 104.  
 Sir William, 105.  
 Leek, Anne, 146.  
 Barbara (Yerburgh), 106.  
 Catherin (Chaworth), 127.  
 Elizabeth, 117.  
 Gertrud, 128.  
 Margerett, 24.  
 Raffe, 128.  
 Robert, 146.  
 Simon, 24.  
 Thomas, 117.  
 William, 106, 127.  
 Leeke, 12, 101, 114.  
 LEEKE, 101.  
 Adam, 101.  
 Agnes, 114.  
 Alexander, 101.  
 Ann, 14, 101.  
 Anne (Robertson), 101.  
 Barbara (Yarborough), 101.  
 Catherin, 166.  
 Charles, 101.  
 Dorathey, 101.  
 Edmond, 101.  
 Elizabeth, 14, 101.  
 Elizabeth (Mercer), 101.  
 Elizabeth (Cooper), 101.  
 Elizabeth (Smyth), 101.  
 Emming (Leeming), 101.  
 Frances, 101.  
 Francis, 101.  
 Horbert, 101.  
 Issabell (Towers), 14.  
 James, 101.  
 Jane (Drax), 101.  
 Jarvis, 101.  
 Joane, 114.  
 Joanne (Talbot), 14.  
 John, 101.

LEEKE—*continued.*

Sir John, 14.  
 Margaret, 14.  
 Mary, 14, 101.  
 Mathew, 101.  
 Sir Simon, 14.  
 Susan, 101.  
 Susan (Lacon), 101.  
 Thomas, 101, 166.  
 William, 101, 114.  
 Leeming, Emming, 101.  
 Francis, 101.  
 Leborne, 105.  
 Leborne —, 105.  
 Leggatt, Catherin, 39, 113.  
 Janne, 43.  
 Jennett, 109.  
 John, 43, 113.  
 Loerose, Idithe, 186.  
 William, 186.  
 [E. of Aubemarle and  
 Champagne], 186.  
 Leigh, 100.  
 LEIGH, 100.  
 Agnes (Conyers), 100.  
 Anne, 43.  
 Barbara, 100.  
 Bridgett, 100.  
 Bridgett (Sotherby), 100.  
 Dorathey, 100.  
 Dorathey (Flower), 122.  
 Dorathey (Thurland), 100.  
 Elizabeth (Ayliffe), 100.  
 Geoffrey, 100.  
 Gervas, 100, 154.  
 Issabell (Poole), 27.  
 Jane (Haddock), 72.  
 John, 27, 43.  
 Myles, 100.  
 Oliffe (Therland), 154.  
 Peter, 72.  
 Reignald, 100.  
 Scisseley, 100.  
 Thomas, 100.  
 William, 100.  
 —, 172.  
 Leigh al's Lee, Gervas, 100.  
 Leighton, Sir Thomas, 60.  
 Leisure, Sir Stephen, 39.  
 Elizabeth (Dabridgcourt), 39.  
 Leke, Sir John de, 45.  
 William, 45.  
 Lomington, Christiana, 53.  
 Esa, 53.  
 Radulphus de, 53.  
 Lespencer, Hugh de, 124.  
 Issabell (Beauchamp), 124.  
 Lovesey, Catherin, 112.  
 Emma, 114.  
 Elizab. (Wightman), 178.  
 —, 29.  
 Levesley, —, 29.  
 Levett, 189.  
 Lewcas, John, 112.  
 Catherin (Row), 112.  
 Lewes, 189.  
 Lewes, Edith (Trussell), 28.  
 Jane (Brondisley), 140.  
 Richard, 140.  
 Thomas, 28.  
 Lowknor, Jane, 175.  
 Thomas, 175.

- Lexbourne, Issabell, 67.  
*Lexinton*, 141, 142.  
 Lexinton, John de, 141, 142.  
 Robert de, 141, 142.  
 Henery de [Bp. of Lincoln],  
 141, 142.  
 —, 5.  
 Ley, Geffry, 25.  
 Mary, 28.  
 Leymur, Petrus, 44.  
 Tor, 44.  
 Linacre, —, 151.  
 Lindsay, Allen de, 75.  
 Alice, 75.  
 Amicia (— ? —), 75.  
 Brasile, 75.  
 David, 75.  
 David de, 75.  
 Galfrey de, 75.  
 Hugh, 75.  
 Liseux, Elizabetha, 170.  
 Issabell (— ? —), 170.  
 Joheis, 170.  
 Lisley, Vist [Grey], 148.  
 Lister, Anne, 60.  
 Charles, 60.  
 Elizabeth, 60.  
 Lawrance, 60.  
 Sir Michell, 60.  
 Sir Richard, 60.  
 Thomas, 60.  
 Litlebery, Elizabeth, 106.  
 Humphry, 106.  
 Littlebury, Humphry, 15.  
 Ursula (Hercye), 15.  
 Littleton, Elizabeth, 149.  
 Ellen (Walsh), 10.  
 Joane, 10.  
 Sir John, 149.  
 Sir William, 10.  
 Lloyde, Ellinor, 34.  
 Evan, 34.  
 Lock, Joane (Wilkinson), 83.  
 Sir William, 83.  
 Lockwood, Mary (Bolles), 95.  
 Thomas, 95.  
*Longford*, 32.  
 LONGFORD, 32.  
 Abraham, 32.  
 Catherin (Bradshaw), 53.  
 Catherin (Comyn), 53.  
 Dorathey, 53.  
 Elizabeth (Lowe), 53.  
 George, 53.  
 Godfrey, 53.  
 Joane, 53.  
 Sir John, 24.  
 Margery, 24.  
 Nicholas, 53.  
 Roger, 53.  
 Thomas, 53.  
 William, 53.  
 Longvile, Anne (Saunders), 84.  
 Sir Thomas, 84.  
 Longvillers, Agnes, 5.  
 Berta (Markham), 23.  
 Elizabeth, 5.  
 John de, 5.  
 Thomas de, 5.  
 William, 23.  
*Loudham*, 188.  
 Loudham, Sir John de, 188.  
 Loughton, Adam de, 70.  
 Ide, 70.  
 Louie, John, 129.  
 Joane (Hynd), 129.  
 Louis, John, 129.  
 Joane (Hynd), 129.  
 Lounders, Helwise, 123.  
 Morrice de, 123.  
 Thomas de, 123.  
 William de, 123.  
 Lovelace, Leonard, 74.  
 Margaret (Molineux), 74.  
 Lovell, Phillipus, 81.  
 Lovett, Ellinor, 107.  
 Low, Clement, 21, 32, 164.  
 Elizabeth, 32.  
 Issabell (Strelley), 21.  
 Mary, 164.  
 Lowden, Joane, 180.  
 Sir John, 180.  
 Lowdham, Catherin (Darcy),  
 49.  
 Elizabeth, 49.  
 Henery, 49.  
 Joane, 49.  
 Sir Thomas, 49.  
 Lowe, Fifeld *als*, 136.  
 Lowth, Lionell, 161.  
 Margerett, 161.  
 Lucey, John, 71.  
 Lucy, Galfridus, 51.  
 Herbertus, 51.  
 Mary, 61.  
 Matilda de, 51.  
 Ricardus de, 51.  
 Sara de, 51.  
 Sir Thomas, 61.  
 Ludeham, Sir Walter de, 45.  
 Ludford, — (Hollis), 61, 62.  
 Luke, Alice (Clarkson), 92.  
 Olive (Claxton), 183.  
 Oliver, 183.  
 Lunn, Ann, 104.  
 Luttrell, Sir Geffery, 124.  
 Joane, 124.  
 Johanna, 45.  
 Lymburg, Ellena de, 52.  
 Phillip de, 52.  
 Lyn, John, 88.  
 Mary, 88.  
*Lynndley*, 119.  
 LYNDLEY, 119.  
 Anne (Rotherwood), 119.  
 David, 119.  
 Ellen (Penfax), 119.  
 Francis, 119.  
 Jane (Molineux), 119.  
 Jane (Knightley), 119.  
 John, 119.  
 Margerett (Evers), 119.  
 Margerett (Farmery), 119.  
 Percivale, 119.  
 Raphe, 119.  
 Richard, 119.  
 Robert, 119.  
 Rose (Clarke), 119.  
 Thomas, 119.  
 William, 119.  
 — (Gowland), 119.  
 Lynley, Francis, 73.  
 Jane (Molineux), 73.  
 Lyon, Agnes (Smyth), 129.  
 Lyon—*continued*.  
 Anne, 129.  
 Dorathey (— ? —), 129.  
 Elizabeth (Lee), 129.  
 Henery, 129.  
 Sir John, 129.  
 Thomas, 129.  
 Lyseux, Elizabeth, 41.  
 Johannes, 41.  
 —, 41.  
 Mabill, John, 55.  
 Mablethorpe, Cassandra, 105.  
 Sir Richard, 105.  
 Mackwilliams, Henry, 8.  
 Margeret, 8.  
 Mackworth, Ellen (Hercye), 15.  
 francis, 15.  
 Madisson, Raffie, 97.  
 Mary (Williamson), 97.  
 Margaret (Williamson), 97.  
 Makerell, — (Cressy), 17.  
*Mallett*, 117, 188.  
 Mallett, Anne, 117.  
 Issabell (Ward), 117.  
 Jane (Francis), 117.  
 Maud, 49.  
 Richard, 117.  
 Robert, 117.  
 Thomas, 49.  
 Sir Thomas, 188.  
*Mallory*, 33.  
 Mallory, Sir Ancketyl, 33.  
 Ellinor, 33.  
 Jane, 60.  
 John, 33.  
 Margery, 138.  
 Margerett, 138.  
 Mary (Willoughby), 145.  
 Roger, 33.  
 Thomas, 33, 145.  
 William, 33.  
 Sir William, 60.  
 Malnoer, Lionius de, 43.  
 Malovell, Elizabeth (Long-  
 villers), 5.  
 Stephen, 5.  
 — (Lexinton), 5.  
 Manby, Anne (Williamson),  
 97.  
 William, 97.  
 Mandevile, Alice (Staunton),  
 180.  
 Stephen, 180.  
 —, 64.  
 Manley, Anne, 102.  
 Edward, 102.  
 Mary, 102.  
 Mary (Willoughby), 102.  
 Prudence (Stone), 102.  
 Willoughby (Stone), 102.  
 Manners, Elizabeth, 143.  
 Sir George, 143.  
 Mannors, Annora, 55.  
 Catherin, 40.  
 George [Ld. Ross], 40.  
 George, 51.  
 Grace, 51.  
 John, 55.  
 Johanna, 55.  
 Louis, 55.  
 Michell, 55.



Mannours, Annora, 44, 48.  
 Hasculpho de, 45.  
 Johanna, 48.  
 Johannes, 48.  
 John, 48.  
 Leonius, 48.  
 Micheal, 44, 45.  
 Sir Michellus, 48.  
*Mannours Lowdham*, 49.  
 Mannurs, Michael, 44.  
 Mansell, Anne (Dabridgcourt), 38.  
 Phillip, 38.  
 Sir Phillip, 38.  
 Sir Rice, 38.  
 Scisseley (Dabridgcourt), 38.  
 —, 37.  
 Mansfield, —, 64.  
 Mantell, Mary, 158.  
 Walter, 158.  
 Mantle, Catherin, 187.  
 Sir Walter, 187.  
 Manwaring, Maud, 28.  
 Randall, 28.  
 Marbury, Elizabeth, 59.  
 Laurence, 8.  
 Margerett (Colshill), 8.  
 March, E. of (Stuart), 18.  
 Countess of (Clifton), 18.  
 Mareshall, Will. de, 45.  
*Markham*, 23, 141.  
 MARKHAM, 23, 24, 25, 26.  
 Abraham, 26.  
 Agnes, 23, 26.  
 Sir Alexander, 23.  
 Alexander, 26.  
 Alice, 24, 26.  
 Alice (Skipwith), 24.  
 Alice (Hercye), 15.  
 Anne, 24, 25, 26.  
 Anne (Strelley), 7, 21, 24.  
 Anne (Henningham), 24.  
 Anne (Laxton), 25.  
 Anne (Warberton), 25.  
 Anne (Hercye), 117.  
 Anne (Ross), 112.  
 Anthony, 26.  
 Sir Anthony, 26.  
 Audella, 24.  
 Barbara (Nevell), 60.  
 Berta, 24.  
 Bridgett (Harrington), 26.  
 Catherine, 24, 25, 26, 76.  
 Catherin (Hartiahorne), 24.  
 Catherin (Babington), 24.  
 Charles, 25, 26.  
 Daniell, 25.  
 Dorothy, 25.  
 Elizabeth, 24, 25, 26, 72.  
 Elizabeth (Burden), 24.  
 Elizabeth (Mering), 13, 24.  
 Elizabeth (Montague), 24.  
 Ellenor (Turbervoyle), 24.  
 Ellinor, 25.  
 Emme, 25.  
 Frances, 24, 26, 152.  
 Francis, 25.  
 George, 25, 26, 118.  
 Gervas, 25.  
 Sir Griffin, 25, 112.  
 Henry, 26.  
 Issabell, 24, 26.

MARKHAM—*continued*.  
 Issabell (—?—), 23.  
 Jane, 25.  
 Jane (Daubney), 24.  
 Jane (Eyre), 15, 26.  
 Jane (Welby), 26.  
 Jerom, 24.  
 Joane (Bothomswell), 23.  
 John, 14, 17, 23, 24, 25, 26, 72, 76.  
 Sir John, 7, 15, 21, 24, 73, 152, 187.  
 Margerett, 24, 25, 148.  
 Margaret (Cressy), 17, 23.  
 Margaret (Leek), 24.  
 Margerett (Villers), 24.  
 Margerett (Hercye), 14.  
 Margery (Longford), 24.  
 Mary, 26.  
 Mary (Griffin), 24.  
 Mary (Leak), 25.  
 Mary (Ley), 25.  
 Mary (Thorold), 26.  
 Mary (Yetsworth), 26.  
 Millicent, 26.  
 Millesent (Bekering), 23.  
 Phillip, 25.  
 Phillipus, 170.  
 Richard, 23, 24, 25, 141.  
 Robert, 13, 15, 23, 24, 25, 26, 60, 117, 141.  
 Robert de, 141.  
 Sir Robert, 15, 24, 25, 72, 148.  
 Scisseley, 23.  
 Thomas, 24, 25, 26.  
 William, 24, 25.  
 Winiffrid (Thorold), 25.  
 — (Nevell), 24.  
 — (Burnell), 25.  
 — (Tirringhan), 26.  
 — (Caunton), 23.  
 — (Lexinton), 141.  
*Marmion*, 28, 145.  
 Marmion, Bridgett, 28.  
 Henry, 28, 147.  
 Issabell (Egerton), 28.  
 — (Willoughby), 147.  
 Marmyon, Elizabeth, 181.  
 John, 181.  
*Marshall*, 70, 91, 97, 166.  
 MARSHALL, 166, 167, 182.  
 Agnes, 166.  
 Agnes (Browne), 166.  
 Alice, 135, 159, 166.  
 Anne, 91, 97.  
 Anne (Cave), 167, 182.  
 Anne (Muston), 166.  
 Catherin, 167.  
 Catherin (Staunton), 181.  
 Catherin (Leeke), 166.  
 Catherin (Nevell), 166.  
 Dorathey, 167.  
 Edmond, 167.  
 Elizabeth, 166, 167.  
 Elizabeth (Bingham), 166.  
 Ellen (Thorpe), 166.  
 Ellenor, 166.  
 Francis, 167.  
 Henry, 167, 182.  
 Humfrey, 167.  
 Issabell, 166.

MARSHALE—*continued*.  
 Joane, 166.  
 John, 91, 97, 166, 167, 182.  
 Katherin, 110.  
 Maude (Scrimshire), 167.  
 Raffe, 135, 166, 167.  
 Richard, 166, 167, 181.  
 Robert, 166.  
 Roger, 166.  
 Simon, 159.  
 Susan, 167.  
 Stephen, 167.  
 Thomas, 166, 167.  
 William, 166, 167.  
 — (Dallisson), 167.  
 — (Assaby), 167.  
 —, 70.  
 Martell, Margaret, 151.  
 Sir Peter, 151.  
 Martin, George, 172.  
 Joane (Power), 177.  
 John, 22.  
 Mary (Strelly), 22.  
 Phillip, 177.  
 Sence (Bevercotts), 172.  
 Martyn Bartholmew, 3.  
 Massingberd, Alice (Bevercotts), 173.  
 Thomas, 172.  
*Masters* [see *Musters*], 142.  
 Matirsey, Thomas, 48, 50.  
 Matteredn, Elizab. (North), 127.  
 Maudit, William, 81.  
 Maulley, Catherin, 78.  
 Maunsell —, 52.  
 Mabilia, 52.  
*Macey*, 157.  
 Maxey, Alice (Roch.), 158.  
 Alice (Fuller), 158.  
 Edmond, 158.  
 Elizabeth, 158.  
 Ellen (Chambers), 158.  
 Frances (Bawdwyn), 158.  
 Henery, 158.  
 John [Bp. of Elphin], 158.  
 Laurence, 158.  
 Mary, 158.  
 Mary (Crawnte), 158.  
 Robert, 158.  
 William, 158.  
 Mealtum, Walterus de, 52.  
*Meares*, 179.  
 Meares, Beatrice, 179.  
 Medcalfe —, 58.  
 MEDHOP, 178.  
 Elizabeth, 178.  
 Elizabeth (Scrimshall), 178.  
 Ellen, 178.  
 John, 178.  
 Laurence, 178.  
 Lettice, 178.  
 Margerett, 178.  
 Thomas, 178.  
 William, 178.  
 Meeres, Barbara (Nevell), 66.  
 Sir John, 66.  
*Meering*, 23.  
 Meering, Elizabeth, 20, 24.  
 Ellenor, 121.  
 Margaret, 42.  
 Millescent (Bekering), 23.

Meering—*continued.*

William, 20, 42.  
 Sir William, 23, 24.  
 Melford, Mary, 68.  
 Melton, 50.  
 Melton, Sir John, 50, 55, 186.  
 Mary (Sutton), 186.  
 Thomasin, 50, 55.  
 Meols, John, 27.  
 Mary (Poole), 27.  
 Mercer, Elizabeth, 101.  
 Merian, Elizabeth, 147.  
 Raffe, 147.  
*Mering*, 12, 33.  
 MERING, 12, 13.  
 Alexander, 12, 13, 33, 35.  
 Sir Alexander, 12.  
 Alice, 13.  
 Ambrose, 13.  
 Anne, 13, 140.  
 Catherin, 13.  
 Catherin (Hercye), 13, 15.  
 Edmond, 13.  
 Edward, 13.  
 Elizabeth, 13.  
 Elizabeth (Houne), 12.  
 Elizabeth (Nevell), 13.  
 Ellenor, 170.  
 Ellinor (Crossy), 12.  
 Francis, 12, 13.  
 Gilbert, 12.  
 Sir Gilbert, 12.  
 Issabell, 33.  
 James, 13, 140.  
 Jane, 13, 33.  
 John, 13, 15.  
 Margaret, 13.  
 Margaret (Cave), 13.  
 Margery, 13, 170.  
 Mary, 13.  
 Maud (Hercye), 12.  
 Maud (Beckering), 12.  
 Millicent, 13.  
 Thomas, 12, 13.  
 Sir Thomas, 13.  
 William, 12, 13.  
 Sir William, 12, 13, 170.  
 — (Hall), 13.  
 — (Laughton), 13.  
 — (Thwaites), 13.  
 Merlan, William de, 51.  
 Mesure, Johne, 54.  
 Metheringham, John, 3.  
 Edmond, 3.  
*Methky*, 188.  
 Methley, Anne (Lister), 60.  
 Bartholomew, 60.  
 Christopher, 60.  
 Elizabeth, 60.  
 John, 59, 136.  
 Joane (Perry), 59.  
 Joane (Bingham), 60.  
 Meverell, Anne (Donham), 160.  
 Elizabeth, 173.  
 George, 160, 173.  
 Meverly, Anne (Donham), 160.  
 George, 160.  
 Michell, Alice, 134.  
 Catherin, 22.  
 Ellenor (Strelley), 21.  
 John, 21.

Michell—*continued.*

Judith (Hill), 21.  
 Thomas, 134.  
*al's Copland*, John, 106.  
 Middleton, Elizabeth, 111, 167.  
 Henricus de, 52.  
 Sir John, 111.  
 Margeria (—?—), 52.  
 Mary, 116.  
 Nicholas, 167.  
 William, 116.  
 Milliner, Isabella, 54.  
 Minors, Catheren, 38.  
 Richard, 38.  
 Mohun, Margerett (Elwis), 29.  
 Molbray, R. de, 51.  
*Molineux*, 72.  
 MOLINEUX, 72, 73, 74.  
 Alice (Cranmer), 73.  
 Alice (Cranmer), 71.  
 Anne, 10, 72, 73, 74.  
 Anne (Hurlington), 73.  
 Anne (Lascelles), 59, 74.  
 Anne (Moting), 74.  
 Anthony, 72, 74.  
 Bridgett (Sabcotts), 74.  
 Bridgett, 74.  
 Catherin, 6, 72, 73.  
 Christian, 74.  
 Christopher, 74.  
 Dorathey, 38, 73, 74.  
 Dorathey (Powtrel), 72.  
 Edward, 73.  
 Edmond, 74.  
 Edmund, 74.  
 Sir Edmond, 73.  
 Sir Edward, 73.  
 Elizabeth, 72, 74, 162.  
 Elizabeth (Markham), 24.  
 Elizabeth (Greenhaugh), 73.  
 Ellen, 73.  
 Etheldred (Herle), 74.  
 " (Vytham), 74.  
 " (Vaughan), 74.  
 Fayth, 74.  
 Frances, 73.  
 Francis, 73.  
 Sir Francis, 73.  
 Gervase, 3, 73, 74.  
 Issabell (Markham), 26.  
 Jane, 73.  
 Jane (Cheney), 73.  
 Jane (Molineux), 73.  
 John, 59, 73, 74, 162.  
 Sir John, 26, 71, 73, 74.  
 Margerett, 72, 73, 74.  
 Margerett (Bussy), 72.  
 Margaret (Comyn), 72.  
 Mary, 73, 74.  
 Mary (Bevercotts), 74.  
 Paule, 74.  
 Ralph, 6.  
 Richard, 72, 73.  
 Sir Richard, 10, 73.  
 Robert, 72, 73.  
 Roger, 73.  
 Ruth (Delwood), 74.  
 Rutland, 74.  
 Sabcotts (74).  
 Theodosia (Heron), 73.  
 Thomas, 24, 71, 72, 73, 74.  
 William, 38, 72, 74.

MOLINEUX—*continued.*

Winifrid, 73.  
 — (Markham), 73.  
 — (Read), 74.  
 Molitum, Henricus de, 52.  
 Mollineux, Catherin (Cotton), 72.  
 Dorathey, 109.  
 Elizabeth (Markham), 72.  
 Frances, 119.  
 Hellen, 142.  
 Jane, 119.  
 Margaret, 116, 146.  
 Mary (Bevercotts), 172.  
 Richard, 72.  
 Sir Richard, 72, 143.  
 Rutland, 172.  
 Thomas, 72, 146.  
 William, 109.  
 Mololacue, Constance (Sutton), 186.  
 Sir Peeter, 186.  
 Molyne, Sir Michell, 149.  
 Elizabeth (Gilbert), 149.  
 Mombocher, Sir Bertram, 145.  
 Issabell (Willoughby), 145.  
*Monbocher*, 47, 49.  
 Monbocher, Bartram, 47, 48, 50.  
 Sir Bartram, 47, 50.  
 George, 47, 50.  
 Sir George, 47, 48, 50, 55.  
 Issabella, 47, 50.  
 Joane, 48, 55.  
 Joane (Charrons), 47, 50.  
 Margaretta, 47, 50.  
 Margaret (Sutton), 47, 50.  
 Margaret (Chaucer), 47, 50.  
 Matilda, 48, 50.  
 Nicholas, 47.  
 Radulphus, 47, 50.  
 Monbocker, George, 17.  
 Issabell, 17.  
 Monboucher, Sir George, 56.  
 Joanne, 56.  
 Monins, John, 71.  
 Jane (Cranmer), 71.  
*Monox*, 189.  
 Mons, Henry, 46.  
 Montague, Sir Edward, 24.  
 Elizabeth, 24.  
 Montgomery, Elizabeth, 164.  
 Sir John, 164.  
 Moore, Cecily, 183.  
 [Lord Chancellor], 183.  
 Sir Thomas, 183.  
 Morston, Alice (Markham), 24.  
 Elizabeth, 71.  
 Morgan, Mary (Moyle), 174.  
 William, 174.  
*Moricale*, 153.  
 Morley, Amphelisia, 67.  
 Elizabeth, 90.  
 Goodith, 163.  
 Sir Robert, 67.  
 Morrey, Anne, 129.  
 Richard, 129.  
*Mortein*, 145.  
 Mortein, Issabell, 145.  
 Sir Roger, 145.  
 Walter de, 45.  
 Mortimer, Anne, 147.  
 Hughe, 126.

*Mortimer—continued.*

- Issabell, 126.  
John, 147.  
Mortmayne, Anne (Ruffo), 14.  
Eustace, 14.  
Sir Roger, 14.  
Thomas, 14.  
Morton, Anne (Wortley), 102.  
George, 102.  
— (Therland, 154).  
Moting, Anne, 74.  
Sir William, 74.  
Moton, Anne, 138.  
Alice (Bassett), 138.  
Edmund, 139.  
Elizabeth, 138, 139.  
Elizabeth (Bugg), 138.  
Margaret (Mallery), 138.  
Margarett (— ?—), 138.  
Phillip (Willoughby), 138.  
Reginald, 138.  
Robert, 138.  
Sir Robert, 138.  
William, 138.  
Motton, Emme, 17.  
Sir William, 17.  
Moulton, Alice (Bassett), 42.  
Robert, 42.  
Susan, 102.  
William, 102.  
Mount-Bocher, Sir George, 50.  
Mountague, Sir Edward, 59, 87.  
,, [note], 86.  
Issabell, 59.  
Margarett, 86, 87.  
Mountegle, Lord [Stanley], 18.  
Mountford, 145.  
Mountgomery, 188.  
Montgomery, Richard, 55, 56.  
Sir William de, 188.  
Mountney, Constance (— ?—), 64.  
John, 64.  
Sir John, 64.  
Robert, 64.  
Mowbegere, } etc., see Mon-  
Mowbeger, } bocher, 47, 49.  
Mowbray, 117.  
Mowbray, —, 52.  
Moyle, 173.  
MOYLE, 173, 174.  
Alice, 174.  
Amye (Langstone), 173.  
Anne, 174.  
Anne (Gooderick), 174.  
Charles, 174.  
Dorathey, 174.  
Elizabeth, 174.  
Jane, 174.  
John, 174.  
Marcye (White), 173.  
Mary, 174.  
Mary (North), 83, 174.  
Raffe, 173.  
Thomas, 173, 174.  
William, 174.  
Moynne, Elizabeth, 106.  
Thomas, 106.  
Mumbly, Sir Lambert, 105.  
Maude, 105.

- Muschamp, Anne, 90.  
William, 90.  
—, 167.  
Musgrove, John de, 80.  
Mussard, — (Flower), 122.  
Musters, 142.  
Musters, Henry, 142.  
Joane, 142.  
Muston, 166, 188; [note] 91, 97.  
Muston, Anne, 166.  
— William, 166.  
Mylles, Emme, 133.  
Neale, Elizabeth, 146.  
Elizabeth (Story), 87.  
Raffe, 87.  
Richard, 153.  
— (Haselbrig), 153.  
Neasfeld, Margerett, 151.  
William, 151.  
Nedham, Anne, 158.  
Henry, 158.  
Neifer, John, 46.  
Nelsonn, Elizabeth, 68.  
Thomas, 68.  
Nevell, 64.  
NEVELL, 64, 65, 66.  
Alexander, 64, 65.  
Alice, 65.  
Alice (Boswell), 65.  
Alice, 17.  
Anne, 43.  
Andrew, 65.  
Anthony, 66.  
Barbara, 65, 66, 79.  
Barbara (Hercye), 15, 65.  
Beatrix, 65, 66, 140.  
Bridgett, 66.  
Catherin, 166.  
Christopher, 65.  
Cutbert, 65.  
Dorathey, 66.  
Dorathey (Dawney), 65.  
Dennys, 66.  
Elizabeth, 13, 65, 66.  
Elizabeth (Cook), 64.  
Elizabeth (Johnson), 65.  
Elizabeth (Boavile), 65.  
Elizabeth (Jermin), 66.  
Edith, 65.  
Ellen (Cutle), 65.  
Ellinor, 34.  
Frances, 66.  
Sir George, 24.  
George, 15, 64, 65, 66, 79, 140.  
Gertrude (Whaley), 66.  
Gervase, 65, 66.  
Gilbert, 66.  
Henry, 65, 66.  
Issabell, 66, 92.  
Issabell (Croftes), 64.  
Issabell (Hare), 65.  
Jane, 65, 89, 113, 154, 182.  
John, 50, 65, 66.  
Sir John, 18, 65, 89, 182.  
Margarett, 50, 64, 65.  
Margarett (Stuting), 65.  
Margerett (Bland), 66.  
Mary, 18, 66.  
Matilda (Stanhop), 6.

*NEVELL—continued.*

- Raffe, 34,  
Richard, 65.  
Robert, 43, 65, 181.  
Rosamond, 65.  
Sara, 66.  
Scissely, 181.  
Susan, 66.  
Thomas, 6, 13, 17, 64, 154, 166.  
William, 64, 65.  
Sir William, 64.  
— (Mandevile), 64.  
— (Woodford), 65.  
— (Oston), 65.  
— (Ostin), 65.  
Nevill, 16.  
Nevill, Radulphus, 79.  
Sir Richard, 141.  
Newark (town and borough), 2.  
Newarke-upon-Trent, Vist.  
[Perpoint], 56.  
Newcomen, Elizabeth, 106.  
Martin, 106.  
Newman, Issabell, 35.  
Sir William, 35.  
Newmarch, 188.  
Newmarch, Sir John de, 188.  
Sir Thomas de, 188.  
Newton, Hugh, 168.  
Jane, 109, 168.  
Sir John, 109.  
Johanne de, 53.  
Mary, 148.  
William, 148.  
Nicholls, Anne (Fincham), 162.  
Nodell, Anne (Cludd), 104.  
Robert, 104.  
Norfolk, D. of, —, 187.  
North, 82, 127.  
NORTH, 82, 83.  
Alice, 82.  
Alice (Squier), 83.  
Anne, 82, 103.  
Charles, 82.  
Christian, 83.  
Christian (Warcoop), 82.  
Dorathey, 82, 83.  
Dorathey (Wray), 82.  
Dorathey (Burnall), 82.  
Dorathey (Dale), 83.  
Dudley, 83.  
Sir Dudley, 83.  
Edward, 82.  
Sir Edward [Ld. North], 83.  
Elizabeth, 82, 83, 127.  
Elizabeth (Staunton), 65, 82, 181.  
Elizabeth (Colwell), 83.  
Elizabeth (Gilbert), 83.  
Ellenor, 83.  
Frances (Brockett), 83.  
Henery, 83.  
Sir Henry, 83.  
Joane, 83.  
John, 82, 83, 103.  
Sir John, 83.  
Judeth, 82.  
Lord, 83.  
Ld. N. of Cartelage, 83.  
Margarett (Butler), 83.  
Mary, 82, 83, 174.

NORTH—*continued.*

Mary (Knivell), 83.  
 Rebecca, 82.  
 Sir Robert, 83.  
 Roger, 65, 82, 83, 181.  
 Sir Roger, 174.  
 Sara (Reyney), 83.  
 Thomas, 65, 82, 83, 181.  
 Winifrid (Rich), 83.  
 Northampton, Marquis (Parr), 111.  
 Norton, Sir Richard, 38.  
 Norwich, Ann (Willoughby), 102  
 Sir Simon, 102.  
 Nottingham [town and borough], 2.

## ODINGSELLS, 75, 76.

Alice, 25.  
 Alice (St. John), 75.  
 Alice (Sharpe), 76.  
 Alice (Butler), 76.  
 Alice (Broune), 76.  
 Amicia (Corbett), 75.  
 Anne (Tresham), 76.  
 Anne (Barwick), 76, 181.  
 Brasile (De Lindsey), 75.  
 Catherin, 76, 134.  
 Catherin (Markham), 76.  
 Edward, 76.  
 Edwardus, 75.  
 Edmond, 75, 76.  
 Elizabeth, 76.  
 Elizabeth (Sutton), 76.  
 Ellenor, 76.  
 Emma (— ? —), 75.  
 Emanuel, 76.  
 Francis, 76.  
 Gabriell, 76, 134, 181.  
 Galfrey, 75.  
 Gerrard, 75, 76.  
 Henery, 76, 143.  
 Hugo de, 75.  
 Hugh, 75.  
 Issabell, 76.  
 Joane (Sutton), 76, 143.  
 Johannes de, 76.  
 Johannes, 75.  
 John, 75, 76.  
 Sir John, 75, 76.  
 Luce (— ? —), 75.  
 Lucey (Beresford), 75.  
 Lucey (Bruce), 75.  
 Margaret (Cockaine), 76.  
 Margaret (Sharpe), 76.  
 Mary (Bernake), 76.  
 Richard, 76.  
 Rowland, 75.  
 Sibell (— ? —), 75.  
 Thomas, 76.  
 William, 75.  
 — (Hyde), 76.  
 — (Raleigh), 76.  
 [Seal], 76.  
 Oylethorpe, 189.  
 Oglethorpe, William, 143.  
 Susan (Sutton), 143.  
 Okonor, Grace, 105.  
 John, 105.  
 Okover, Rafe, 160.  
 Catherin (Donham), 160.

Oland, Elizabeth (Cole), 77.  
 William, 77.  
 Oliver, Elizabeth (Samon), 36.  
 Walter, 45.  
 Onley, Edward, 140.  
 Mary, 140.  
 Onslow, Catherin, 176.  
 George, 176.  
 Orby, Alice, 138.  
 John, 138.  
 Sir John, 105.  
 Issabell, 105.  
 Orleton, —, 103.  
 Ormesby, Arther, 105.  
 Ormond, Anne, 127.  
 Elizabeth, 127, 152.  
 Elizabeth (Chaworth), 127.  
 Joane, 127.  
 Joane (Chaworth), 127, 152.  
 John, 127, 152.  
 Orrell, Elizabeth, 112.  
 Peter, 112.  
 Osborne, 31, 183.  
 OSBORNE, 31.  
 Alice, 31.  
 Alice (Boteler), 31.  
 Alice (Hewett), 31.  
 Edward, 31.  
 Sir Edward, 31.  
 fraunces (Harvey), 31.  
 Sir Hewett, 31.  
 Joyce (fleetwood), 31.  
 William, 31.  
 — (Belases), 31.  
 Ostin, —, 65.  
 Oston, —, 65.  
 Otter, John, 114.  
 Margaret (Southworth), 114.  
 Oversall, Anne, 164.  
 Sir Hugh, 164.  
 Overton, Gresill, 98.  
 John, 98.  
 Owelys, —, 182.  
 Owen, Jane (Hunt), 167.  
 Owghtred, Dorathey, 40.  
 Sir Robert, 40.  
 Owle, 121.  
 Owlys, — (Nevell), 89.  
 Pabenharn, 123.  
 Pabenharn, Catherin, 126.  
 Ellinor, 126.  
 Elizabeth (Clifford), 125.  
 Elizabeth (Engaine), 126.  
 Joane (Daubney), 126.  
 John, 125, 126.  
 Sir Laurence, 126.  
 Thomas, 125.  
 — (Uford), 125.  
 Paganell, John, 186.  
 Issabell, 186.  
 [Lord Dudley], 186.  
 Page, Elizabeth, 7.  
 Elizabeth (Bourchier), 7.  
 Richard, 7.  
 Pagenham, John, 126.  
 Pagett, Will., Lord, 149.  
 Palmer, Adam, 28.  
 Dorathey (Trussell), 28.  
 John, 178.  
 Margerett (Medhop), 178.  
 Paramore, Thomas, 102.

Paramore—*continued.*

Margt. (Willoughby), 102.  
 Pargiter, William, 149.  
 Abbigale (Willoughby), 149.  
 Parker, John, 22.  
 Rosamond, 22.  
 Richard, 2.  
 Parkes, Catherin, 162.  
 Sir Phillipp, 62.  
 Parkhurst, Anne (Elwis), 29.  
 Sir William, 29.  
 Parkins, 87 [note], 159.  
 PARKINS, 159, 160.  
 Adrian, 160.  
 Anne, 159.  
 Arden, 160.  
 Elizabeth, 159.  
 Elizabeth (Beresford), 159.  
 Francis, 107, 159.  
 George, 160.  
 Henry, 87, 160.  
 Issabell, 160.  
 Issabell (Wood), 87.  
 Isham, 160.  
 John, 160.  
 Margaret, 159.  
 Mary, 160.  
 Mary (Isham), 160.  
 Penelopic, 160.  
 Richard, 107, 159, 160.  
 Parnell, Richard, 4.  
 Parr, Catherin [Queen], 111.  
 W. [Marquis of Northampton], 111.  
 Parsons, James, 34.  
 Catherin (Fenton), 34.  
 Thomas, 34.  
 Paston, Anne, 128.  
 Mary, 128.  
 William, 128.  
 Pate, John, 66.  
 Mary (Nevell), 66.  
 Thomas, 66.  
 Payne, —, 62.  
 Paynell, Dorathey, 59.  
 Geoffrey, 59.  
 Issabell (Strelley), 21.  
 Richard, 21.  
 Payton, Alice, 31.  
 Robert, 31.  
 Pearsonn, Joane, 129.  
 John, 129.  
 Peckham, Frances, 110.  
 Elizabeth (Cartwright), 109.  
 Sir George, 21.  
 Reginald, 109, 110.  
 — (Willoughby), 21.  
 Pedwarden, Elizabeth (Lowdham), 49.  
 Margaret (Markham), 24.  
 Sir Robert, 29.  
 Walter, 24.  
 Peech, Florence (Chichley), 90.  
 Sir Nicholas, 90.  
 Peers, Margaret, 7.  
 Peirpoint, Sir Henry, 2.  
 Pelham, Edmond, 91.  
 Ellen (Darrell), 91.  
 Pell, Sir Anthony, 102.  
 Alice (Flower), 122.

Pell—*continued.*

- Elizabeth (Willoughby), 102.  
 Thomas, 122.  
 Pembridge, Mary, 27.  
 Raffe, 27.  
 Pembroke, W. E. of, 111.  
 Pendock, 107.  
 PENDOCK, 107.  
 Barrey, 107.  
 Elizabeth, 107.  
 Ellinor (Lovett), 107.  
 Francis (Parkins), 107, 159.  
 George, 107.  
 Gervase, 107.  
 John, 107, 159.  
 Margaret (Heyton), 107.  
 Maud (Barry), 107.  
 Richard, 107.  
 William, 107.  
 Penfax, Ellen, 119.  
 William, 119.  
 Peniston, Mary, 118.  
 Thomas, 118.  
 Pennington, John, 181.  
 Catherin, 181.  
 Penris, Avico, 37.  
 John, 37.  
 Percy, Abraham, 137.  
 Elizabeth (Draper), 137.  
 Maude (Sutton), 186.  
 Sir William, 186.  
 Perers, John de, 52.  
 Perir, Willianus de, 52.  
 Sibilla, 52.  
 Perkins, Elizabeth, 95.  
 Thomas, 95.  
*Perpoint*, 44, 49.  
 PERPOINT [including *Perpoint*, *Perpoynt*, *Perpoynte*, *Perpointe*, etc.], 43 to 56.  
 Anne, 50, 56.  
 Annora, 48.  
 Annora (Mannours), 44, 45, 55.  
 Edmond, 48, 50, 56.  
 Sir Edmond, 20, 44, 45, 46.  
 Sir Edmond, 56.  
 Elizabeth, 20, 50, 164.  
 Elizabeth (Beauchamp), 48.  
 Elizabeth (Harris), 51.  
 Ellen (Langford), 55, 56.  
 Francis, 50, 51, 56.  
 Francis (Cavendish), 51, 56.  
 Frances, 51, 56.  
 Sir George, 18, 50, 56, 116.  
 Gertrude (Talbot), 51, 56.  
 Grace, 51, 56.  
 Henery, 45, 48, 49, 50, 51, 56.  
 Sir Henery, 43, 44, 45, 46, 47, 49, 50, 51, 55, 56, 110.  
 Jane (Herris), 50.  
 Joane (Empson), 50, 56.  
 Joane (Mountbocher), 50, 56.  
 Margerett, 17, 51, 55, 56.  
 Margaret (Langford), 50.  
 Margaret (Fitz William), 50, 56.  
 Margaret (Bardon), 50, 56.  
 Mary, 110.  
 Maude (Mallett), 48.

PERPOINT—*continued.*

- Sir Nicholas, 30.  
 Sir Raffe, 48.  
 Robert, 44, 46, 50, 51, 56.  
 Sir Robert, 17, 44, 46, 47, 48, 49, 50, 55.  
 Sara (Heriz), 44, 48, 55.  
 Thomasin (Melton), 50, 56.  
 William, 51, 56.  
 Sir William, 56, 164.  
 Winifrid (Thwaites), 18, 50, 56.  
 Sir —, 143.  
 — (Hackett), 50.  
 — (Montgomery), 50.  
 — (Roos), 50.  
 — (Aunslowe), 56.  
 Pert, Dorathey (Goodere), 175.  
 Thomas, 175.  
 Petinger, — (Cartwright), 109.  
 Pettit, Anne, 147.  
 John, 147.  
 Petyt, John, 94.  
 Lucy (Watts), 94.  
 Pewsey, —, 102.  
 Phettiplace, Mary, 88.  
 Thomas, 88.  
 Pickering, 188.  
 Pickering, Christopher, 18.  
 Dorathey (Clifton), 18.  
 James, 58.  
 Margaret (Lascells), 58.  
 Sir James, 58.  
 Picoth, Peter, 80.  
*Pigott*, 10; note, 115; 142.  
 Pigott, Christian, 103.  
 Edmond, 10.  
 Elizabeth, 10, 42.  
 Gervase, 10.  
 George, 42.  
 Sir Hugh, 142.  
 Issabell, 142.  
 Jane, 10, 115.  
 Joane, 10, 115.  
 Jane (Bradshaw), 10.  
 Margaret (Roby), 10.  
 Margaret (Handforth), 10.  
 Thomas, 10.  
 Pilkenton, Edmond, 151.  
 Margery (Babington), 151.  
 Pilkington, Anne, 36.  
 Edward, 79.  
 Thomas, 36.  
 Mary, 79.  
 Pinkney, Alice (Lindsey), 75.  
 Henry de, 75.  
 Robert de, 75.  
 Pirton, Anne, 111.  
 Plantagenet, Henry [Earl of Lanc], 124.  
 Maud (de Cardusis), 124.  
 Plomer, Mary (Elwis), 30.  
 Thomas, 30.  
*Plompton*, 16.  
 Plumpton, Alice (Foliamb), 171.  
 Anne, 139.  
 Elizabeth, 171.  
 Elizabeth (Stapleton), 171.  
 Elizabeth (Clifford), 171.  
 Issabell, 164.  
 Margery, 171.

Plumpton—*continued.*

- Sir Robert, 139, 171.  
 William, 171.  
 Sir William, 171.  
*Plumtree*, 188, 190.  
 Plumtree, Ann (Parkins), 159.  
 Pollard, Anthony, 152.  
 Mary (Hilton), 87.  
 Thomazin, 152.  
*Poole*, 27.  
 POOLE, 27.  
 [at's Pull], 27.  
 [vel de la Poole], 27.  
 Agnes, 27.  
 Alice (Babington), 151.  
 Anne (Hooks), 27.  
 Anna (Plumpton), 139.  
 Beatrix (Babington), 151.  
 Bennett (Boys), 27.  
 Dorathey (Cockaine), 139.  
 Edward, 139.  
 Elizabeth, 78, 140.  
 Elizabeth (Stanley), 27.  
 Elizabeth (Bretton), 27.  
 Elizabeth (Moton), 138.  
 Elizabeth (Parkins), 159.  
 Francis, 27, 139.  
 German, 139.  
 Germanus, 139.  
 Sir German, 139.  
 Henry, 27, 139.  
 Issabell, 27.  
 James, 27.  
 Janne (Fitzherbert), 7, 139.  
 John, 7, 27, 139.  
 Sir John, 27.  
 Katherin (Vernon), 139.  
 Mary, 27.  
 Mary (Pembridge), 27.  
 Maud (Randall), 27.  
 Peter, 78.  
 Raffe, 27, 140, 151.  
 Randall, 27.  
 Reginald, 138.  
 Reignald, 27.  
 Richard, 27.  
 Rowland, 27.  
 Scissely, 27.  
 Thomas, 27.  
 Sir Thomas, 27.  
 William, 27.  
 — (Bureton), 27.  
 — (Capenhurst), 27.  
 — (Croker), 27.  
 Pope, Bryan, 156.  
 Margaret (Symcock), 156.  
 Port, Dorathey, 7.  
 Elizabeth, 7.  
 Elizabeth (Gifford), 7.  
 Johanne (Fitzharbert), 7.  
 Sir John, 7.  
 Margareta, 7.  
 Porter, Robert, 190.  
 Portington, Margaret, 106.  
 Thomas, 106.  
 —, 41.  
 Poultney, Anne (Shirley), 10.  
 Francis, 10.  
 Gabriell, 10.  
 Sir Thomas, 10.  
*Poutrell*, 188.  
 Poutrell, Sir Robert, 188.

- POWER, 176, 177.  
 Anne (Elliott), 177.  
 Christopher, 176.  
 Daniel, 177.  
 Elizabeth, 177.  
 Francis, 177.  
 George, 177.  
 Joane, 177.  
 John, 177.  
 Joseph, 177.  
 Josua, 177.  
 Judith, 177.  
 Mary, 177.  
 Nathaniell, 177.  
 Richard, 177.  
 Samewell, 177.  
 Stephen, 176.  
 William, 177.  
 — (Cressy), 176.  
 — (Rookwood), 176.
- Powtrel, Dorathey, 72.  
 Bridgett, 36.  
 Dorathey (Bassett), 42,  
 170.  
 Elizabeth (Lowdham), 49  
 John, 21, 85, 92.  
 Margaret (Strelley), 21.  
 Mary, 85.  
 Sir Robert, 49.  
 Senc', 92.  
 Sanchia, 92.  
 Thomas, 36, 42, 72, 170.  
 William, 92.
- Pull, Poole al's, 27.
- Purefoy, Anna (Bingham),  
 121.  
 Catherin, 132, 178.  
 Michell, 132, 178.  
 Radulphus, 121.
- Purefoy, Jane (Vincent),  
 139.  
 Nicholas, 139.
- Puttenham, Dorathey, 38.  
 Sir George, 38.
- Pycott*, 188.  
 Pycott, Sir Pers, 188.
- Pym, Henery, 190.  
 Mary (Dabridgecourt), 38.  
 Reignald, 38.
- Quadring, Scissely, 71.  
 Quarles, Alice (North), 82.  
 Catherin (Chaworth), 128.  
 John, 82.
- Quenesburgh, Cicilia de, 52.
- Quincy, Roger de [E. of Win-  
 chester], 80.
- Rabon*, 34.  
 Rabon, Hugh, 34.  
 Joyce, 34.
- Raby*, 64.
- Radcliff, Joanna (Stanhop), 6.  
 Ralph, 6.  
 Robert, 6.  
 —, 64.
- Radcliffe, Alice (Byron), 10.  
 John, 9.  
 Sir John, 10.  
 — (Byron), 9.
- Radford, East* [Town and Bo-  
 rough], 4.
- Radley, Brigett (Yerburgh),  
 106.
- Raleigh, —, 76.
- Ramstone*, 188.  
 Ramstone, Sir Thomas, 188.
- Rand, John, 46.
- Randall, John, 61.  
 Maud, 27.  
 — (Hollis), 61.  
 —, 62.
- Rasen, Robertus de, 46.  
 Annora, —, 46.
- Rason, Robert de, 55.  
 Annora (Mannours), 55.
- Rattlef, Sir John, 8.  
 Mary, 8.
- Rawson, Anna, 7.  
 Avery, 94.  
 Beatrix (Cooke), 7.  
 Margaret, 94.  
 Nicholas, 7.  
 Phillip, 172.
- Read, Bridgett, 184.  
 Dorathey, 184.  
 Elizabeth, 184.  
 Jane, 184.  
 John, 169.  
 Margaret (Alphew), 184.  
 Mary, 184.  
 Mary (Beresford), 169.  
 Robert, 184.  
 Sir Robert, 184.  
 —, 8.  
 —, 74.
- Reade, Griffith, 183.
- Reding, Elizabeth, 22.  
 Thomas, 22.
- Redman, Elizabeth (Compton),  
 128.  
 Sir Walter, 128.
- Redmer, —, 35.
- Rempston, Margeria, 121.  
 Simon, de, 45.  
 Thomas, 121.
- Reresby, Arnold, 118.  
 Jane, 68.  
 John, 57.  
 Lyon, 68.  
 Margaret (Lascells), 57.  
 Margaret (Whalley), 118.
- Restwood, — (Boyvill), 171.  
 —, 111.
- Retford* [Town and Borough], 4.
- Revell*, 34.  
 Revell, Ellenor, 34.  
 John, 34.  
 —, 136.
- Reynalds, Mary, 131.  
 Robert, 131.
- Reyner, Anthony, 65.  
 Elizabeth, 56.  
 Margaret (Nevell), 64.  
 Richard, 64.  
 Sir William, 56.
- Reynes*, 108.
- REYNES, 108.  
 Andrew, 108.  
 Catherin, 108.  
 Dorathey, 108, 155.  
 Dorathey (Bassett), 108.  
 Elizabeth, 108.  
 Florence (Bradshaw), 108.
- REYNES—*continued*.  
 Jane, 108.  
 Joyce, 108.  
 John, 108, 155.  
 Margery, 108.  
 Mary, 108.  
 Nicholas, 108.  
 Robert, 108.  
 Thomas, 108.  
 — (Armstrong), 108.
- Reyney, John, 83.  
 Sara, 83.
- Reynolds*, 131.
- Reyton, Ann, 93.
- Rhodes, Anne, 42.  
 Francis, 42.
- Riall, — (Delamare), 38.
- Rice, William, 190.
- Rich, Elizabeth (Colwell), 83.  
 Penelope, 18.  
 Richard, Lord, 83.  
 Robert, 83.  
 Robert [E. of Warwick], 18.  
 Winifrid, 83.
- Richard, John, 54.
- Richardson, Agnes, 130.
- Richers, Richard, 109.  
 Elizabeth (Cartwright), 109.
- Ridgway, Cassandra, 185.  
 Lord [in Ireland], 185.  
 Thomas, 185.
- Ridley, Margaret, 183.  
 Margaret (Musgrave), 183.  
 Nicholas, 183.
- Rigs, Anne (Mering), 13.
- Ripers, Ellen, 69.
- Risley, Joane, 145.
- Roades*, 69.
- Roades, Sir John, 69.  
 Sergeant, 69.
- Roberts, Francis, 77.  
 Anne (Yerburgh), 106.  
 George, 90.  
 Richard, 106.  
 Rose (Darrell), 90.
- Robertson, Anne, 101.  
 Bridgett (Bevercotts), 172.  
 Thomas, 172.
- Robinson, Alice, 135.  
 Elizabeth, 137.  
 Henery, 137.  
 Thomas, 135.  
 —, 144.
- Roby*, 115.
- Roby, John, 115.  
 Margaret, 115.
- Roch, Alice, 158.  
 Elizabeth (North), 127.  
 Elizabeth (Lascells), 57.  
 William, 158.  
 Sir William, 57.
- Rochford*, 179.
- Rochford, Sir George, 179.  
 Joanna, 6.
- Rocloff, Agnes, 58.  
 Sir Robert, 58.
- Rodney*, 143.
- Rodney, Anne, 143.  
 Elizabeth, 92, 183.  
 John, 92, 143.
- Roe, Mary, 91.  
 Thomas, 91.

- Rogers, Hugh, 41.  
 Mary (Cressy), 41.  
 Rokesby, Christopher, 59.  
 John, 59.  
 — (Lascells), 59.  
 Mary (Cartwright), 110.  
 Thomas, 110.  
 Roleston, Issabell (Bradborne), 151.  
 Rollston, Ann (Babington), 151.  
 James, 151.  
 Margeria (Bingham), 121.  
 Ralph, 121.  
*Rollston, also Rowleston, 169.*  
 ROLSTON, 169, 170.  
 Ann (Babington), 169.  
 Anthony, 170.  
 Edward, 170.  
 Ellinor (Mering), 170.  
 Henery, 169.  
 Issabell, 170.  
 James, 169, 170.  
 Jane, 170.  
 John, 170.  
 Lancelott, 170.  
 Mary, 170.  
 Raffe, 169.  
 Robert, 170.  
 Thomas, 169, 170.  
 Vallentyne, 170.  
 William, 169.  
 — (Bingham), 169.  
 — (Ashe), 170.  
 Rombold, Audrey, 176.  
 John, 176.  
 Roodes, John, 166.  
 Jennett (Hawkes), 166.  
 Robert, 166.  
 Rooke, Ann (Goodere), 176.  
 Thomas, 176.  
 Rookwood, —, 161, 176.  
 Rooper, Joyce (Chaworth), 124.  
 ROOS, 111, 112.  
 Agnes (Harvy), 111.  
 Agnes (Colly), 112.  
 Alice, 112.  
 Anne, 25, 112.  
 Anne (Pirton), 112.  
 Anthony, 112.  
 Catherin, 112.  
 Catherin (Levesey), 112.  
 Dargovill [Steward, Ld. of Galloway], 111.  
 Edward, 112.  
 Elizabeth (Middleton), 111.  
 Elizabeth (Orrell), 112.  
 Elizabeth (Blague), 112.  
 Ellen, 112.  
 Ellinor (Wandisford), 111.  
 Francis, 111, 112.  
 George, 112.  
 Gilbert, 112.  
 Henery, 112.  
 Humfrey, 111.  
 Issabell [d. of King of Scots], 111.  
 Joane, 112.  
 John, 111, 112.  
 Margaret (Bruse), 111.  
 Mary, 111, 112.  
 Mary (Gastlin), 112.  
 Michell, 112.
- Roos—*continued.*  
 Peter, 25, 111, 112.  
 Richard, 112.  
 Robert, Ld. [Roos], 111.  
 Robert, 111.  
 Sir Robert, 111.  
 Roger, 112.  
 Theodocia, 112.  
 Thomas, 111, 112.  
 William, 111, 112.  
 Lord [Mannors], 40.  
 — (Restwold), 111.  
 — (Scrimshire), 111.  
 — (Roos), 111.  
 — (Orrell), 112.  
 — (Darwen), 112.  
 — (Warren), 112.  
 —, 50.  
 Roper, Elizabeth, 183.  
 John, 183.  
*Ropsley, 179.*  
 Ropsley, Alice, 179.  
*Ros, 188.*  
 Ros, Sir John de, 188.  
 Sir Robert de, 188.  
 Roskin, Jasper, 55.  
 Roskymer, Alice (Deynsyll), 61.  
 William, 61.  
 Rosse, Anne, 186.  
 William Lord, 186.  
*Rossell, 119.*  
 ROSSELL, 119, 120.  
 Catherin (Sacheverell), 120.  
 Dorathey (Cranmer), 71, 120.  
 Elizabeth, 120.  
 George, 116, 120.  
 Gervase, 120.  
 Henery, 71.  
 Harold, 120.  
 Issabell, 120.  
 Issabell (Babington), 120, 151.  
 John, 120, 151.  
 John de, 119, 120.  
 Margaret (Whalley), 116, 120.  
 Mary (Cranmer), 120.  
 Robert, 120.  
 Simon de, 119.  
 Thomas, 120.  
 Wilfrid de, 119.  
 Roswell, Elizabeth, 21.  
 Rotheram, Beatrix, 159.  
 — (Linacre), 159.  
 Rotherwood, Anne, 119.  
*Roulston, 33.*  
 Roulston, Agnes, 33.  
 Raffe, 33.  
 Routh, James, 28.  
 Ursula (Trussell), 28.  
 Rowcliff, Sir John, 171.  
 Margery (Plompton), 171.  
*Rowleston, 169.*  
 Rowleston, Lancelott, 121.  
 Ellinor (Meering), 121.  
 Rowlett, Sir Raffe, 175.  
 Ursula, 175.  
*Rowlston, 64.*  
 Royden, Mary, 91.  
 Roydon, Prudence (Cornwallis), 161.
- Royston, Jerome, 177.  
 Mary (Power), 177.  
 Ruffo, Anne, 14.  
 Issabell (Arches), 14.  
 Sir William, 14.  
 Runce, John de, 45.  
 Ruskin, Jasper, 54.  
 Russell, Jane, 108.  
 John, 26.  
 Termyn, 108.  
 Theodocia (Markham), 26.  
 Russella, Onte, 52.  
 Hugo, 52.  
 Rutland, E. of [Mannors], 40.  
 Ryther, Elizabeth, 97.  
 Ryton, Anne, 92.
- Sabcotts, Bridgett, 74.  
 Robert, 74.  
*Sacheverell, 163.*  
 SACHEVERELL, 163, 164, 165.  
 Agnes (Kirby), 164.  
 Anne, 22, 165.  
 Anne (Leech), 163.  
 Anne (Francis), 164.  
 Anne (Oversall), 164.  
 Anthony, 165.  
 Catherin, 162, 164.  
 Catherin (Fitzherbert), 164.  
 Dorathey, 165.  
 Elizabeth, 86, 163, 164.  
 Elizabeth (Grey), 164.  
 Emma (Dethick), 164.  
 Frances, 165.  
 Hellen, 165.  
 Henery, 116, 164, 165.  
 Sir Henery, 122, 127, 152.  
 Hyacinthus, 165.  
 Issabell, 165.  
 Issabell (Stathom), 164.  
 Jane, 116, 164, 165.  
 Jane (Bradborne), 165.  
 Joane, 165.  
 Joane (Curzon), 163.  
 Joane (Stathom), 163.  
 John, 163, 164, 165.  
 Lucey, 165.  
 Mary, 122, 127, 164, 165.  
 Mary (— ? —), 163.  
 Mary (Low), 164.  
 Millicent, 165.  
 Patrick, 22, 164.  
 Sir Patrick, 163.  
 Sir Peter, 163.  
 Rafe, 163, 164, 165.  
 Sir Raffe, 86.  
 Richard, 164.  
 Sir Richard, 163.  
 Robert, 163, 164.  
 Sir Robert, 163.  
 Sence (Bevercotts), 172.  
 Thomas, 164, 165, 172.  
 Sir William, 163.  
 — (Willoughby), 147.  
 Sackford, Dorathey (North), 83.  
 Henery, 83.  
*Sadington, 153.*  
 Salley, Alice, 104.  
 Thomas, 104.  
 Salmon, Thomas, 151.

- Salmon—*continued*.  
 Scissely (Babington), 151.  
 Saltmarsh, Thomas, 40.  
 Margt. (Constable), 40.  
*Samon*, 35.  
 SAMON, 35, 36.  
 Anne, 36.  
 Anthony, 35.  
 Edward, 38.  
 Elizabeth, 35, 36.  
 Issabell, 35.  
 Issabell (Newman), 35.  
 Issabell (Delalaund), 35.  
 Jane (Draycott), 35.  
 Jane (Mering), 13, 35.  
 John, 35, 36.  
 Katherin, 35.  
 Mary, 35.  
 Mary (Entwisell), 35.  
 Myllescent, 35.  
 Nicholas, 35.  
 Richard, 13, 35.  
 Robert, 35.  
 Scisseley (Babington), 35.  
 Thomas, 35.  
 Wilfryd, 35.  
 — (Ballard), 35.  
 — (Redmer), 35.  
 Sampson, Amphelis, 16.  
 Sir William, 16.  
 SANDERSON, 100.  
 Ann (Gell), 100.  
 Christopher, 100.  
 Dyonis (Barber), 100.  
 Elizabeth, 100.  
 Elizabeth (Carr), 100.  
 Henery, 100.  
 Mary, 100.  
 Robert, 100.  
 William, 100.  
 Sandersonn, Jane (Hollis), 62.  
 Thomas, 62.  
*Sandford*, 168.  
 SANDFORD, 168.  
 Catherin, 168.  
 Francis, 168.  
 Jane (Newton), 168.  
 Joane (Smyth), 168.  
 John, 168.  
 Maude (—?—), 168.  
 Roger, 168.  
 William, 168.  
 Sandford, Sir Brian, 58.  
 Dorathey, 58.  
 Elizabeth (Greene), 58.  
 Sandis, Sir Edwin, 18.  
 Hester (Clifton), 18.  
 Myles, 18.  
 Sir William, 18.  
 Sands, Elizab. (Cornwallis),  
 162.  
 Sir Walter, 162.  
 William, 14.  
 Santon, Anthony, 42.  
 Anne (Bassett), 42.  
 Sarringham, Alice (Blondes-  
 ton), 158.  
 Saunders, Anne, 84.  
 Bridgett, 147.  
 Laurence, 84.  
 Robert, 147.  
 Sir Thomas, 175.  
 Savage, Ann (Beresford), 169.  
 Elizabeth (Mering), 13.  
 Humphrey, 94.  
 James, 13.  
 John, 169, 187.  
 Sir John, 9.  
 Margaret (Jessop), 94.  
 — (Byron), 9.  
 SAVELL, 174.  
 Anne (Wyatt), 174.  
 Arther, 174.  
 Bridgett, 66, 174.  
 Catherin (Hunings), 174.  
 Cordall, 174.  
 Dorathey, 97.  
 Edward, 174.  
 Francis, 174.  
 George, 174.  
 Sir George, 174.  
 Henery, 174.  
 Sir Henery, 66.  
 Jane (Gascoigne), 174.  
 Joane (Vernon), 174.  
 John, 97, 174.  
 Sir John, 174.  
 Margaret (Basford), 174.  
 Mary, 174.  
 Mary (Welbeck), 174.  
 Susan (Shakelton), 174.  
 Thomas, 174.  
 Ursula, 174.  
 Savile, John, 132.  
 Mary, 132.  
 Savill, Elizabeth, 70.  
 Sir John, 70.  
 Say, Lord, 37.  
 Scaldeford, Achardo de, 52.  
 Hugo de, 52.  
 Richardus de, 52.  
 Scopham, Agnes (Disney), 61.  
 Elizabeth, 62.  
 George, 61, 62.  
 Scott, Anne, 90.  
 Sir Reginald, 90.  
 Richard, 90.  
 Scrimshall, Elizabeth, 178.  
*Scrimshere*, 166.  
 Scrimshere, Geoffrey, 167.  
 Agnes (Bingham), 167.  
 Elizabeth (Middleton), 167.  
 Richard, 167.  
 Thomas, 167.  
 William, 167.  
 Scrimshire, Edward, 172.  
 Barbara (Bevercotts), 172.  
 Maude, 167.  
 William, 167.  
 Scroope, Henry, Lord, 82.  
 John, Lord, 126.  
 Elizabeth (Chaworth), 126.  
 Ellinor (North), 82.  
 —, 127.  
 Sedgwick, —, 59.  
 Segar, Sir Will., 49 [note].  
*Segrave*, 16.  
 Selby, Johannes de, 53.  
*Seliok*, 117.  
 Seliok, Dorathey (Chaworth),  
 127.  
 Issabell, 117.  
 John, 127.  
 Sir John, 127.  
 Semer, Anne (Stanhop), 7.  
 [D. of Somerset], 7.  
 Semnermarsh, Anne, 49.  
 John, 49.  
 Serceby, Hugh, 46, 47.  
 Serelby, Hugh, 47.  
*Serlby*, 127.  
 Serlby, Andrew, 128.  
 Ankarett, 127.  
 Anthony, 128.  
 Gertrud (Leek), 128.  
 Serleby, Margaret, 172.  
 Shakelton, Susan, 174.  
 Shaleros, Leonard, 95.  
 Mary, 95.  
 Sharpe, Alice, 76.  
 Henery, 76.  
 Margerett, 76.  
 Sheffield, Edmond, Lord, 62.  
 Ellinor, 62.  
 Sheffield, Elizabeth, 147.  
 Sheldon, Edward, 25.  
 Elizabeth (Markham), 25.  
 Raffe, 25.  
 Shelford, Hugo de, 45.  
 Shelton, Anne (Barrow), 162.  
 Isabell, 9.  
 Jane, 21.  
 Peter, 9.  
 Sir Raffe, 162.  
 Thomas, 21.  
 Shepard, Samwell, 175.  
 Margaret (Goodere), 175.  
 —, 30.  
 Sheppard, —, 147.  
*Sherbrooke*, 132.  
 SHERBROOKE, 132.  
 Alice (Braillesford), 132.  
 Catherin, 183.  
 Elizabeth, 132.  
 Elizabeth (Hall), 132.  
 Margaret, 132.  
 Mary (Savile), 132.  
 Robert, 132.  
 Thomas, 132, 183.  
 Sherley, Alice, 133.  
 Ellenor (Willoughby), 147.  
 George, 21.  
 Joane, 21.  
 Sir Raffe, 147.  
 Sherman, Mary (Lascells), 59.  
 William, 59.  
 Shipman, Thomas, 190.  
 Shirley, Anne, 10.  
 Elizabeth (Walsh), 10.  
 Ellenor, 153.  
 Sir Raffe, 10, 153.  
 Shreese, John, 156.  
 Margery, 156.  
 Shrewsbury, E. of [Talbot], 4, 51.  
 Shrimpton, John, 148.  
 Frances (Willoughby), 148.  
 Shrusse, John, 156.  
 Margery, 156.  
 Sibthorpe, —, 180.  
 Simcock, Alice (Sutton), 143.  
 Thomas, 143.  
 Simpson, Nicholas, 42.  
 Elizabeth (Bassett), 42.  
 — (Sacheverell), 164.  
 Singleton, Eliz. (Cornwallis),  
 161.



- Sixstanby, William de, 54.  
 Skeffington, Issabell (Byron), 10.  
 Margeria (Stanhop), 6.  
 Thomas, 6, 10.  
 Skevington, Mary, 79.  
 Thomas, 79.  
 Skewis, Catherin, 61.  
 John, 61.  
 Skinner, John, 25.  
 Jane (Markham), 25.  
 Jane (Elwis), 29.  
 Thomas, 25, 29.  
 Sir Thomas, 29.  
 Skipton, Elizabeth (Page), 7.  
 William, 7.  
 Skipwith, Agnes, 106.  
 Alice, 24.  
 Anne, 57.  
 Sir John, 106, 141.  
 Sir William, 24, 57.  
 Skrimshire, Thomas, 111.  
 Skudamore, Richard, 147.  
 Catherin (Willoughby), 147.  
 Slaughter, Elizabeth, 168.  
 Richard, 168.  
 Story [seal also], 86.  
 Slory, Agnes, 87.  
 Sir Alford, 87.  
 Alicia, 86.  
 Sir Alured, 87.  
 Anne, 87, 139.  
 Elizabeth, 87.  
 Elizabeth (Hesull), 87.  
 Elizabeth (Sacheverell), 86,  
 163.  
 Ermintrud, 87.  
 Johannes, 86.  
 Johannes de, 86.  
 Sir John, 87.  
 Sir Norman, 87.  
 Richard, 86, 87.  
 Thomas, 86, 87.  
 William, 86, 87, 139, 163.  
 Sir William, 87.  
 — (Colwick), 86.  
 Slorye, Mary (Beaumont), 87.  
 Richard, 87.  
 Smith, Giles, 93.  
 Katherin, 93.  
 Mary (Flower), 122.  
 Smithwirck, Hugh, 38.  
 Jane (Dabridgcourt), 38.  
 Smyth, Ann (Markham), 25.  
 Catherin, 92.  
 Elizabeth, 101.  
 Sir Francis, 25.  
 Frances, 89.  
 Joane, 168.  
 Martin, 101.  
 Roger, 168.  
 Sir Richard, 95.  
 Sir Thomas, 25.  
 Snayth, Elizabeth, 134.  
 Snow, Anne (Stanton), 181.  
 Mary (Power), 177.  
 William, 181.  
 Somerey, The Lord [Somerie],  
 125.  
 Somerscales, Rebecka, 89.  
 Robert, 89.  
 Somershall, Rafe, 190.  
 Somery, E. of [Paganell], 186.  
 Sorpey, 188.  
 Sorpey, Sir John de, 188.  
 Sotherby, Bridgett, 100.  
 Robert, 100.  
 Souch, George, 116.  
 Sir John, 187.  
 South, Alice, 185.  
 Sir Francis, 85.  
 Southampton, Thos. E. of  
 [Wriothesley], 161.  
 Southcoate, — (Babington),  
 151.  
 Southwell, Alice (Cornwallis),  
 162.  
 Richard, 162.  
 SOUTHWORTH, 114.  
 Anne (Elsam), 114.  
 Aymond, 114.  
 Edward, 114.  
 Elizabeth, 114.  
 Ellen (Harris), 114.  
 Emma (Levesey), 114.  
 Issabell, 91.  
 Margaret, 114.  
 Richard, 114.  
 Robert, 114.  
 Sparke, Ann, 93.  
 Robert, 93.  
 Spence, Sibbell (Byron), 9, 10.  
 William, 9, 10.  
 Spencer, Elizabeth, 21.  
 Joane, 145.  
 Sir John, 21.  
 Margaret (Willoughby), 149.  
 Robert, Lord, 149.  
 Squier, Alice, 83.  
 Squier, John, 28.  
 Jane (Trusell), 28.  
 St. Andrea vel St. Andrew, 78.  
 ST. ANDREW vel ST. AN-  
 DREA, 78, 79, 80, 81.  
 Agnes (Grey), 78.  
 Alice, 79.  
 Alice (Stoke), 78.  
 Alice (— ? —), 78.  
 Anne, 79.  
 Barbara, 79.  
 Barbara (Nevell), 79.  
 Catherin, 79.  
 Catherin (Wells), 79.  
 Catherin (Maulley), 78.  
 Crueburga (— ? —), 78.  
 Dorathey, 79.  
 Edmond, 78.  
 Edmondus, 78.  
 Elizabeth, 78, 79.  
 Elizabeth (Poole), 78.  
 Elizabeth (Bainbridg), 79.  
 Ellinor, 79.  
 George, 79.  
 Henricus de, 78.  
 Hugh, 78.  
 Ivo de, 78.  
 Jacobus de, 80.  
 Jane, 79.  
 James de, 78.  
 Johanna (— ? —), 78.  
 Johannes de, 78.  
 Johannes Seiherus de, 79.  
 John, 78, 79.  
 Sir John, 78.  
 Julian (Zouch), 78.  
 St. ANDREW vel St. ANDREA—  
 continued.  
 Laurentius, 80.  
 Margaret, 79.  
 Margaret (Aston), 78.  
 Mary (Pilkington), 79.  
 Mary (Skevington), 79.  
 Matilda de, 80.  
 Maud (Dive), 78.  
 Maud (— ? —), 78.  
 Paganus de, 78.  
 Peter de, 78.  
 Richard, 78.  
 Robert, 78.  
 Sir Robert de, 78, 80, 81.  
 Roger, 78, 79, 80.  
 Sir Roger, 78.  
 Sir Saiher, 78, 81.  
 Sanchia, 79.  
 Seiherus, 81.  
 Thomas, 78.  
 William, 78, 79, 80.  
 St. Cruse, Agnes (Markham),  
 23.  
 William, 23.  
 St. George, Elizab. (St. John),  
 60.  
 George, 60.  
 Henery, 60.  
 Sir Henery, 60.  
 Mary (Darell), 60.  
 Richard, 60.  
 Sir Richard, 60.  
 Thomas, 60.  
 Willianus de, 79.  
 St. John, Alice, 75.  
 Elizabeth, 60.  
 Elizabeth (Blount), 60.  
 Ellinor, 60.  
 John, 75.  
 Sir John, 60.  
 Nicholas, 60.  
 Sir Oliver, 60.  
 [Vis' Grandison], 60.  
 — (Leighton), 60.  
 St. Low, Egidius, 6.  
 Margaret (Stanhop), 6.  
 Stafford, Humffrey, 40, 126.  
 Ellinor (Aylesbury), 126.  
 Joyce, 40.  
 Margerett (Bassett), 124.  
 Edward, Lord, 124.  
 Staine, Anne, 105.  
 Sir William, 105.  
 Staley, Johanna, 6.  
 Ralph, 6.  
 Stanfford, —, 160.  
 Stanhop, 5.  
 STANHOP, 5, 6, 7, 8.  
 Adelina (Clifton), 18.  
 Alexander, 8.  
 Alicia (Fly), 6.  
 Anne, 6, 7, 8, 62.  
 Anna (Strelley), 7, 21, 24.  
 Anna (Rawson), 7.  
 Audelia (Clifton), 7.  
 Audella (Markham), 24.  
 Avelina (Clifton), 7.  
 Byron, 8.  
 Catherin, 8.  
 Catherin (Molineux), 6.  
 Catherin (Trentham), 7.

STANHOP—*continued.*

Catherin (Hastings), 8.  
 Charles, 8.  
 Cordelia, 8.  
 Cordelia (Allington), 7.  
 Cromwell, 8.  
 Dorathea, 8.  
 Dorathey (Trentham), 7.  
 Edmond, 6, 7, 8.  
 Edward, 8, 18.  
 Elizabeth, 6, 8.  
 Elizabeth (Malovell), 5.  
 Elizabeth (Talbot), 6.  
 Elizabeth (Bourchier), 7.  
 Ellenora, 6, 8, 140.  
 Ellena (Wolfull), 7.  
 Francisca, 8.  
 Henery, 6, 8.  
 Issabella (Markham), 6, 24.  
 James, 6.  
 Jane, 8, 15.  
 Jane (Curlon), 8.  
 Joanna (Rochford), 6.  
 Johanna, 6, 20.  
 Johanna (Staley), 5.  
 John, 5, 6, 7, 8, 15.  
 Sir John, 8.  
 Juliana, 8.  
 Margaret, 6, 8.  
 Margaret (Jerningham), 6.  
 Margaret (Port), 7.  
 Margaret (Colshill), 8.  
 Margaret (Mackwilliams), 8.  
 Margaret (Peers), 8.  
 Margeria, 6.  
 Marmaduke, 7.  
 Mary, 8.  
 Mary (Rattlef), 8.  
 Mary (Hawley), 8.  
 Matilda, 6.  
 Matilda (Cromwell), 6.  
 Micheall, 8.  
 Michell, 7, 8.  
 Sir Michell, 140.  
 Nicholas, 6.  
 Olivia (Beresford), 8.  
 Olliefe, 8.  
 Phillip, 8.  
 Radcliffe, 8.  
 Raffe, 6.  
 Sir Raffe, 24.  
 Richard, 5, 6, 7, 20, 24, 152.  
 Sir Richard, 21.  
 Richard de, 5.  
 Robert, 6, 24.  
 Sir Robert, 24.  
 Sancia, 7.  
 Sara, 8.  
 Sence, 152.  
 Stephen, 6.  
 Susan, 8.  
 Thomas, 6, 7, 8.  
 Sir Thomas, 62.  
 Ursula, 8.  
 William, 6, 8.  
 [Earl of Chesterfield], 8.  
 Lord [of Harrington], 8.  
 — (Knowles), 8.  
 — (Read), 8.  
 Stanley, 143, 190.  
 Stanley, Anne, 18, 93.  
 Barbara, 84.

Stanley—*continued.*

Elizabeth, 15, 27, 143.  
 Gertrude (Hollis), 63.  
 Henry, 93, 190.  
 Sir John, 15.  
 Richard, 84.  
 Sir Thomas, 18, 143.  
 Walter, 63.  
 Sir William, 27.  
 Stanthom, Issabell, —, 164.  
 Stanton, 153, 179, 189.  
 STANTON, 179, 180, 181.  
 Alice, 180.  
 Alice (Ropsley), 179.  
 Anne, 181.  
 Anne (— ?—), 181.  
 Anthony, 65.  
 Athelin (Whitworth), 179.  
 Beatrix (Meares), 179.  
 Bridgett, 181.  
 Bridgett (Barwick), 181.  
 Sir Bryan de, 179.  
 Catherin, 181.  
 Catherin (Disney), 181.  
 Edith, 181.  
 Edith (Nevell), 65.  
 Elizabeth, 65, 152, 180, 181.  
 Elizabeth (Thorne), 180.  
 Ellen, 181.  
 George, 180.  
 Sir Geoffrey, 179, 180.  
 Sir Henery, 179.  
 Issabell (Chaworth), 180.  
 Joane (Eincourte), 180.  
 Joane (Lowden), 180.  
 John, 179, 180, 181.  
 Sir John, 180, 181.  
 Sir Maior, 179.  
 Margaret, 180.  
 Mary, 181.  
 Nicholas, 180.  
 Richard, 180.  
 Robert, 65, 180, 181.  
 Scisseley (Nevell), 181.  
 Sir Simon, 80.  
 Theobald, 179.  
 Thomas, 153, 179, 180, 181.  
 Sir Thomas, 180.  
 William, 180, 181.  
 Sir William, 179, 180.  
 — (Chawser), 179.  
 — (Gifford), 179.  
 — (Fitzallen), 179.  
 — (Rochford), 179.  
 — (Bosam), 180.  
 Staple, Ann (Wood), 88.  
 Staples, Robert, 2.  
 Stapleton, Sir Brian, 171.  
 Catherin (Constable), 40.  
 Elizabeth, 171.  
 George, 158.  
 Sir Robert, 40.  
 Staresmore, Francis, 139.  
 Mary (Vincent), 139.  
 Starkey, John, 129.  
 Joane (Hynd), 129.  
 Margaret, 132.  
 Thomas, 132.  
 Stathom, Eliz. (Langley), 163.  
 Goodith, 163.  
 Henery, 163.  
 Joane, 163.

Stathom—*continued.*

John, 163.  
 Scisseley (— ?—), 163.  
 Thomas, 163.  
 Thomazin (Curzon), 163.  
 Staunford, 161.  
 Staunford, Elizabeth, 161.  
 John, 161.  
 Staunton, 34.  
 Staunton, Anthony, 82.  
 Dorathey, 34.  
 Elizabeth, 32, 133.  
 Jane, 9.  
 Margeret (Byron), 9.  
 Margery, 9.  
 Mary (Yerburgh), 106.  
 Richard, 106.  
 Robert, 134.  
 Thomas, 106.  
 Staveley, 14.  
 Staveley, George, 20.  
 Issabell (Strelley), 20.  
 Steynford, Ann, 172.  
 William, 172.  
 Stepey, 188.  
 Stepey, Sir John de, 188.  
 Stephan, Margaret (Stanhope), 6.  
 Stephenson, Catherin, 140.  
 Jane, 89.  
 John, 89, 140.  
 Sterley, Ann (Perpoint), 56.  
 Sir Nicholas, 56.  
 Stevenson, Elizabeth, 103.  
 William, 103.  
 Steward, Esmev [E. of March], 18.  
 [Stewart, —] E. of Galloway, 111.  
 Stirley, Anne (Perpoint), 50.  
 Sir Nicholas, 50.  
 Stockham, Robert, 4.  
 Anne, 97.  
 Stockwith, 176.  
 STOCKWITH, 176.  
 Edmond, 176.  
 Henery, 176.  
 Humfrey, 176.  
 Robert, 176.  
 Thomas, 176.  
 Stoke, Alice, 78.  
 Richard, 78.  
 Stone, Prudence, 102.  
 Thomas, 102.  
 Stotehill, Alice, 171.  
 Anne, 171.  
 Anne (Boyvill), 171.  
 Arther, 172.  
 Elizabeth, 172.  
 Elizabeth (Plumpton), 171.  
 Henery, 171, 172.  
 Jane, 172.  
 Jane (Empson), 172.  
 John, 171, 172.  
 Robert, 172.  
 Thomas, 172.  
 Stourton, Ann (North), 82.  
 Thomas, 82.  
 Stoxes, Sara, 177.  
 Strange, —, 157.  
 Anne (Paston), 128.  
 Strechley, 188.  
 Strechley, Sir John, 188.

*Strelley*, 19, 168.  
**STRELLEY**, 19, 20, 21, 22.  
 Agnes (Harcourt), 20.  
 Alice, 10, 20, 22.  
 Anne, 7, 20, 21, 24, 121.  
 Anne (Aldredg), 21.  
 Anne (Baynham), 22.  
 Anne (Sacheverell), 22.  
 Anne (Perpoint), 55.  
 Anthony, 22.  
 Sir Anthony, 21, 22.  
 Bridgett (Thwaites), 21.  
 Catherin (West), 20.  
 Dorathey (Burrell), 22, 99.  
 Elizabeth, 20, 21, 116.  
 Elizabeth (Vavasour), 19.  
 Elizabeth (Hercye), 20.  
 Elizabeth (Perpoint), 20.  
 Elizabeth (Garneys), 21.  
 Elizabeth (Roswell), 21.  
 Elizabeth (Reding), 22.  
 Elizabeth (Mering), 13.  
 Ellen (Gresley), 21.  
 Ellinor, 21.  
 Francis, 21.  
 George, 21, 22, 99.  
 Gervase, 22.  
 Gertrud (Eye), 22.  
 Gertrud, 22.  
 Grace (Digby), 21.  
 Helen, 20.  
 Henery, 20, 21, 22.  
 Sir Henery, 20.  
 Issabell, 20, 21, 22, 164.  
 Issabell (Kemp), 20.  
 Jane, 20, 22, 86, 148.  
 Joane, 165.  
 Joane (Stanhope), 6, 20.  
 Joane (Hunt), 20.  
 Joane (Baynham), 21, 22.  
 Joane (Sherley), 21.  
 John, 13, 20, 21, 22, 24, 86,  
 116, 148, 165.  
 Lucia (le Fone), 19.  
 Margaret, 22.  
 Mary, 21, 22.  
 Mary (—?—), 20.  
 Mary (Thornbury), 22.  
 Nicholas, 21, 22, 121, 168,  
 187.  
 Sir Nicholas, 10, 20, 21, 55.  
 Patricke, 21.  
 Sir Phillip, 21.  
 Richard, 19, 20.  
 Robert, 6, 19, 20.  
 Sir Robert, 19, 20.  
 Rosamond (Parker), 22.  
 Sampson, 19, 20.  
 Sir Sampson, 20.  
 Sara (Willoughby), 20.  
 Sara (Digby), 21, 168.  
 Sanchia (Willoughby), 20.  
 Sence (Willoughby), 148.  
 Stephen, 19.  
 William, 19, 22.  
 Sir William, 148.  
 — (Berroyke), 20.  
 — (Willoughby), 21.  
**STRETTON**, 89.  
 Elizabeth, 89.  
 Ellen (Kniveton), 89.  
 Frances (Smyth), 89.

**STRETTON—continued.**  
 Roger, 89.  
 Thomas, 89.  
 Strey, Nicholas, 190.  
*Stringer*, 85.  
**STRINGER**, 85.  
 Alice (South), 85.  
 Alice, 130.  
 Ann, 85.  
 Eliza, 85.  
 Francis, 85.  
 John, 85.  
 Mary (Powtroll), 85.  
 Mary (Hartop), 85.  
 Nicholas, 85.  
 Richard, 85.  
 Robert, 85.  
 Thomas, 130.  
 William, 85.  
 Strong, Ann (Bevercotts), 172.  
 Thomas, 172.  
 Strowde, Thomas, 18.  
 — (Clifton), 18.  
 Stuffing, — (Cartwright),  
 109.  
*Sturdivant*, 159.  
**STURDIVANT**, 159.  
 Alice, 159.  
 Alice (Marshall), 159.  
 Anne, 43, 159.  
 Beatrix, 159.  
 Beatrix (Rotherham), 159.  
 Christopher, 159.  
 Elizabeth, 159.  
 Francis, 159.  
 John, 43, 159.  
 Lucey, 159.  
 Margaret, 159.  
 Margaret (Clarke), 159.  
 Richard, 159.  
 Thomas, 159.  
 William, 159.  
 Stuting, Margaret, 65.  
*Styneton*, 16.  
 Suffolk, D. of [Brandon], 41.  
 Sulliard, Edward, 161.  
 Mary, 161.  
*Suthill*, 16.  
 Suthill, Barbara, 40.  
 Sir Gerard, 40.  
 Sir Henery, 40.  
 Henery, 40.  
 John, 40.  
 Mary, 40.  
 — (Salwyn), 40.  
 — (Powcher), 40.  
*Sutton*, 12, 141, 142, 189; *see*,  
 141.  
**SUTTON**, 141, 142, 143, 144,  
 186.  
 Agnes, 144.  
 Agnes (Barre), 142.  
 Alice, 143.  
 Alice (Bingham), 142, 144.  
 Alice (Biron), 9, 143.  
 Alice (Hall), 143.  
 Alice (Harrington), 143.  
 Alice (Mering), 13.  
 Amandus, 186.  
 Amandus, Lord, 186.  
 Anne, 144.  
 Anne (Rodney), 143.

**SUTTON—continued.**  
 Anne (Rosse), 186.  
 Anthony, 143.  
 Barbara, 143.  
 Beatrix (Watton), 186.  
 Catherin (Fitzwilliams), 142.  
 Catherin (Bassett), 42, 143,  
 170.  
 Constance, 186.  
 Constance (—?—), 186.  
 Constance (Burnell), 99.  
 Edmund, 143, 144.  
 Edward, 140, 143.  
 Elizabeth, 76, 143.  
 Elizabeth (Stanley), 143.  
 Elizabeth (Manners), 143.  
 Francis, 143.  
 Gervase, 143.  
 Glyva (Cooper), 140.  
 Harrington, 144.  
 Hellen (Molineux), 143.  
 Henery [note], 142.  
 Henery, 9, 18, 143, 144.  
 Sir Henery, 143.  
 Idithe (Legrose), 186.  
 Issabell (Pigott), 142.  
 Issabell (Creake), 144.  
 Issabell (Paganell), 186.  
 Jacobus de, 141.  
 Jane, 143.  
 Joane, 143.  
 Joane (Musters), 143.  
 Johane (Ayncourt), 186.  
 Sir James, 142.  
 John de, 46.  
 John, 143, 144, 172, 186.  
 Sir John, 186.  
 Katherin (Hasty) [note],  
 142.  
 Lucia (Bartram), 141.  
 Mabell (Bardolffe), 186.  
 Margaret, 18, 47, 50.  
 Margaret (Hussey), 142.  
 Marke, 143.  
 Mary, 143, 186.  
 Maude, 186.  
 Nicholas, 143.  
 Olive, 143.  
 Olive (Cooper), 143.  
 Richard, 13, 141, 142, 143,  
 144.  
 Sir Richard, 47, 50, 186.  
 Robert, 9, 141, 142, 143.  
 Sir Robert, 142.  
 Rowland, 141, 142, 143.  
 Sir Rowland, 142.  
 Sence (Bevercotts), 172.  
 Serius, Lord, 186.  
 Seward, Lord, 186.  
 Susan (Cony), 143.  
 Thomas, 99, 170, 186.  
 Sir Thomas, 42, 143.  
 William, 76, 143, 144.  
 William, Lord, 186.  
 William de, 46, 141.  
 Sir William, 143, 186.  
 Zaunche (Bevercotts), 143.  
 — (Lexington), 141, 142.  
 — (Robinson), 144.  
 — (Albanye), 186.  
 [Ld. Dudley], 186.  
 [Ld. Lexington], 142.

- Swarland*, 153.  
 Swifte, Anne, 94.  
   Sir Robert, 94.  
 Swillington, Margaret, 45.  
   Margaret (Bellers), 44, 46.  
   Robert, 44.  
   Sir Roger, 44.  
 Swinford, Roger, 157.  
 Swyneborne, Catherin, 135.  
   Nicholas, 135.  
*Symcock*, 156.  
 SYMCOCK, 156.  
   Alexander, 156.  
   Alicce, 156.  
   Christopher, 156.  
   Dyer, 156.  
   Humfrey, 156.  
   Joane, 156.  
   Margarett, 156.  
   Margarett (Guppie), 156.  
   Margarett (Jessop), 156.  
   Margery (Shreese), 156.  
   " (Shruse), 156.  
   Mary (Halswell), 156.  
   Thomas, 156.  
   William, 156.  
 Symonds, Thurston, 137.  
   Sara (Draper), 137.  
  
 Talbott, Elizabeth, 6.  
   Henry, 51, 56.  
   Gertrude, 51, 56.  
   Gilbert, 4, 51, 56.  
   Elizabeth (Reyner), 56.  
   Joane, 14.  
   Sir John, 14.  
   Mary, 56.  
   Thomas, 6.  
   [E. of Shrewsbury], 4, 51, 56,  
   127.  
*Talboys*, 77.  
 Tamworth, John, 149.  
   Dorathey (Colby), 149.  
 Tanffeld, Dorathey, 84.  
   Francis, 84.  
*Tate*, 84.  
 TATE, 84.  
   Anne (Saunders), 84.  
   Anthony, 84.  
   Sir Barthelmew, 84.  
   Barthelmew, 84.  
   Barbara (Stanley), 84.  
   Bridgett, 84.  
   Dorathey (Tanffeld), 84.  
   Elizabeth, 84.  
   Elizabeth (Zouch), 84.  
   Francis, 84.  
   George, 84.  
   John, 16, 84.  
   Sir John, 84.  
   Margarett, 84.  
   Margarett (Digby), 84.  
   Margarett (—?), 84.  
   Mary, 84.  
   Sir Robert, 84.  
   Saunders, 84.  
   Thomas, 84.  
   William, 84.  
   Sir William, 84.  
   Zouch, 84.  
 Taversham, John, 158.  
   Elizabeth (Blondeston), 158.  
  
 Tayler, Jane, 18.  
   Sir Lawrence, 18.  
 Taylor, Martin, 4.  
   Richard, 178.  
   Sibbell (Wightman), 178.  
*Tee*, 189.  
 Terwhitte, John, 147.  
   Margaret (Griffith), 147.  
 Tesard, Roger, 52.  
 Tevery, Catherin (Chaworth),  
   128.  
   Robert, 128.  
 Tey, —, 161.  
*Teye*, 161.  
*Teyes*, 105.  
 Therland, 154.  
 THERLAND, 154, 155.  
   Alicce, 154.  
   Anne (Elliott), 154.  
   Anne (Chaworth), 128.  
   Catherin, 154.  
   Dorathey, 154, 155.  
   Edmond, 128, 154.  
   Edward, 154, 155.  
   Elizabeth, 155.  
   Elizabeth (Gosling), 154.  
   Ellen, 155.  
   Elliott, 155.  
   George, 154.  
   Gervase, 154.  
   Issabell (Welby), 154.  
   Issabell (Plumpton), 154.  
   Jane, 154.  
   Jane (Nevell), 154.  
   Jane (Willoughby), 154.  
   John, 154.  
   Olliffe, 154.  
   Olliffe (Bretton), 154.  
   Plumpton, 154.  
   Rachell, 155.  
   Richard, 155.  
   Thomas, 154.  
   Welberas, 154.  
   William, 154.  
 Thorbury, Mary, 22.  
   Thomas, 22.  
 Thornbury, —, 175.  
 Thorne, Sir Brian, 180.  
   Elizabeth, 189.  
*Thornhegh*, 69.  
 THORNHEGH, 69, 70.  
   Anthony, 69, 70.  
   Avery, 69.  
   Bridgett, 70.  
   Elizabeth, 70.  
   Ellen (Ripers), 69.  
   Francis, 70.  
   Henry, 70.  
   Jane, 70.  
   Jane (Jackson), 70.  
   John, 46, 69, 70.  
   Sir John, 69.  
   Penelope, 70.  
   — (Bailes), 69.  
   — (Roades), 69.  
 Thornhill, Catherin, 97.  
   Elizabeth, 87, 130.  
   Francis, 82.  
   Margarett, 97.  
   Mary (Norton), 82.  
   Robert, 87, 130.  
   Sir Robert, 97.  
  
 Thornock, Nicholas, 106.  
   Joane (Yerburgh), 106.  
 Thornton, —, 84.  
   William, 4.  
 Thornworth, Dorathey (Colby),  
   149.  
   John, 149.  
 Thorold, Anthony, 172.  
   Alicce (Cranmer), 7.  
   Alicce (Stanton), 180.  
   Anne, 25.  
   Anne (Bevercotts), 172.  
   Anne (Constable), 18.  
   Sir Anthony, 18, 26.  
   John, 180.  
   Sir John, 71.  
   Margarett (Sutton), 18.  
   Mary, 26.  
   Thomas, 25.  
   Winiffrid, 18, 25.  
 Thorpe, Adam, 166.  
   Ellen, 166.  
   — (Lister), 60.  
 Throgmorton, John, 107.  
   Barbara (Elwis), 30.  
   Ellinor, 107.  
 Thunstall, Reginald de, 53.  
 Thurland, Edward, 100.  
   Dorathey, 100.  
   Jane, 160.  
   Jane (Willoughby), 148.  
   Thomas, 148.  
   Sir Thomas, 160.  
*Thuaites*, 16, 49.  
 Thwaites, Anthony, 22.  
   Bridgett, 22.  
   William, 18.  
   Sir William, 50, 56.  
   Winiffrid, 18, 50, 56.  
   —, 13, 59.  
 Tiffin, Elizabeth (Whalley),  
   118.  
   William, 118.  
 Tilliol, Maud (Lascells), 58.  
   Robert, 58.  
 Tiptofte, Eve (de Carducis), 124.  
   Sir John, 124.  
 Tiringham, Sir James, 26.  
*Tirrell*, 161.  
 Tirrell, Edward, 161.  
   Phillipa, 161.  
*Tirringham*, 180.  
 Tirringham *al's* Trickingham,  
   180.  
   John, 126.  
   Ellenor (Pabenham), 126.  
   Margarett (Stanton), 180.  
   Sir Theobald, 180.  
 Tirwhite, Anne (Bassett), 42.  
   Sir Edward, 29.  
   Margarett, 40.  
   Martha, 29.  
   Sir Robert, 40.  
   Robert, 42.  
 Todd, Issabell, 131.  
   John, 131.  
*Tolley*, 140.  
 Tolley, John, 140.  
   Scisseley, 140.  
 Toly, Jane, 68.  
   John, 68.  
 Tomson, Thomas, 54.

- Tong*, 84.  
**TONG**, 84, 85.  
 Cressy, 85.  
 Dorathey (Cressy), 85.  
 John, 84.  
 Margery, 85.  
 Nicholas, 85.  
 Susanna (Bulby), 85.  
 Thomas, 85.  
 — (Thornton), 84.  
 — (Illingworth), 85.  
 — (Wooddes), 85.  
 Topcliff, Joane, 58.  
 Jane (Willoughby), 149.  
 Sir John, 58.  
 Richard, 149.  
 Torkerd, John, 46.  
 Torkington, Anne, 97.  
 John, 97.  
 Tortismaria, Radul., 44.  
 Totlock, Catherin, 146.  
 John, 146.  
 Tottishurst, Margaret, 184.  
 Elizabeth (Willoughby), 184.  
 Richard, 184.  
 Thomas, 184.  
 Touchett, Alice (Driby), 42.  
 Alice (Orby), 138.  
 Maud (Bromhall), 37.  
 Robert, 37.  
 Sir Robert, 42, 138.  
*Tonke*, 188.  
 Tonke, Sir Walter, 188.  
*Towers*, 14.  
 Towers, Issabell, 14.  
 John, 14.  
 Townesend, Elizabeth, 104.  
 Jane (Stanhop), 8.  
 Roger, 8.  
 Thomas, 104.  
 Tracy, — (Digby), 168.  
 Trafford, John, 88.  
 Margaret (Wood), 88.  
 Travers, Bryan, 152.  
 Elizabeth, 152.  
 Trentham, Catherin, 7.  
 Dorathey, 7.  
 Thomas, 7.  
 Tresham, Anne, 76.  
 Trickingham, Tiringham *ar's*, 180.  
 Trigott, Luce, 168.  
 Thomas, 168.  
 Trihant, Galfridus, 52.  
 Troutbeck, John, 61.  
 Margery (Hollis), 61.  
 Troyse, Elizabeth, 40.  
 Robert, 40.  
 Trumpington, Everard, 79.  
*Trussell*, 28, 131.  
**TRUSSELL**, 28.  
 Alice, 131.  
 Allured, 28.  
 Anne, 28.  
 Avery, 28.  
 Bridgett (Marmion), 28.  
 Catherin, 28.  
 Catherin (Trussell), 28.  
 Catherin (Ithell), 28.  
 Dorathey, 28.  
 Edith, 28.  
 Elizabeth, 28.
- TRUSSELL—continued.**  
 Geoffrey, 131.  
 Hènery, 131.  
 Joane, 28.  
 John, 28.  
 Margaret, 28.  
 Margaret (fulwood), 28.  
 Mary, 28.  
 Maud (Venables), 28.  
 Maud (Manwaring), 28.  
 Robert, 28.  
 Sara (Ketlewood), 28.  
 Scisseley, 28.  
 Scisseley (Cursonn), 28.  
 Theobald, 28.  
 Sir Thomas, 28.  
 Warren, 28.  
 Sir William, 28.  
 Tuke, Sir Brian, 89, 182.  
 Judeth (North), 82.  
 Thomas, 82.  
 — (Bland), 89, 182.  
 Tunderley, Warinus de, 81.  
 Tunstall, Sir Marmaduke, 55, 56.  
 Turbervyle, Ellenor, 24.  
 Sir John, 24.  
 Turner, Edward, 42.  
 Elizabeth (Brookesby), 133.  
 Hènery, 133.  
 Margaret (Bassett), 42.  
 Turnhill, John de, 46.  
 Turvile, Margaret, 138.  
 Twentiman, John, 3.  
 Twyford, Elizabeth, 163.  
 Sir Robert, 163.  
*Tye*, 189.  
 Tye, —, 161.  
 Ufford, —, 125.  
 Upton, Hamond, 105.  
 Julian, 105.  
*Urwick*, 136.  
 Urswick, —, 136.
- Vaughan*, 74.  
 Vaughan, Alice, 71.  
 Anthony, 71.  
 Etheldred, 71.  
 Hughe, 71.  
 Sir Hugh, 71.  
 John, 71.  
 Susan (Cranmer), 71.  
*Vaus*, 188.  
 Vaus, Sir John de, 188.  
 Vavasor, Elizabeth, 19.  
 Elizabeth (Cressy), 17.  
 William, 19.  
 Vawdy, Joane, 87.  
 Mary (Wood), 87.  
 Robert, 87.  
 Venables, Maud, 28.  
 Verney, Elizabeth (Bourchier), 7.  
 Vernon, Humffrey, 139.  
 Joane, 174.  
 Katharene, 139.  
 William, 174.  
 Viliers, Sir John de, 45.  
*Villers*, 188.  
 Villers, Anne, 133.  
 Sir Frances de, 188.  
 John, 24.
- Villers—continued.**  
 Sir John, 133.  
 Margaret, 24.  
 Villiers, Bartholomew, 54.  
 John, 54.  
*Vincent*, 138.  
**VINCENT**, 138, 139.  
 Anne (Grimesby), 139.  
 Anne (Slory), 87, 139.  
 Anne (Coles), 139.  
 Anne (Eyre), 139.  
 Anthony, 139.  
 Clement, 139.  
 David, 128.  
 Edmond, 128.  
 Edward, 139.  
 Elizabeth (Goodall), 139.  
 George, 87, 139.  
 Gervase, 139.  
 Gilbert, 139.  
 Jane, 128, 139.  
 Mary, 139.  
 Peter, 139.  
 Phillip, 139.  
 Richard, 139.  
 Thomas, 139.  
 William, 139.  
 — (Bernard), 139.  
*Vytham*, 74.  
 Vytham, Etheldred, 74.  
 John, 74.
- Wade, Fayth (Yerburgh), 106.  
 Randolfe, 106.  
 Wadham, Anne (Saunders), 84.  
 Wake, Elizabeth, 37.  
 John, Lord [Wake], 37.  
 John, 183.  
 Margaret, 133.  
 Walcott, Alice, 96.  
 Anne (Brookesby), 133.  
 Walden, Alice (Byron), 9, 10.  
 John, 16.  
 William, 9, 10.  
 Waldron, Humffrey, 184.  
 Mary (Willoughby), 184.  
 Walesch, Lady Albrida de, 80.  
 Waley, Gertrude, 66.  
 Richard, 66.  
 Walkeden, Ann (Goodere), 176.  
 Thomas, 176.  
 Walkedyne, Francis, 102.  
 William, 102.  
*Walker*, 130.  
**WALKER**, 130.  
 Alice, 130.  
 Agnes (Richardsonn), 130.  
 Elizabeth, 130, 168.  
 Elizabeth (Digby), 130.  
 Gregory, 130, 168.  
 Gertrude, 130.  
 John, 130.  
 Mary (Brendialey), 140.  
 Robert, 140.  
 Wall, Ursula (Yerburgh), 106.  
 Walley, Elizabeth (Strelley), 20.  
 Thomas, 20.  
 Wallis, Alice, 168.  
 John, 168.  
 Wallys, —, 148.  
 Walpoole, Arther, 181.  
 Elizabeth (Stanton), 181.

Wandisford, Christopher, 31,  
59, 111.  
Ellinor, 59, 111.  
— (Osborne), 31.  
Warborton, Anne, 25.  
Sir John, 25.  
Warcop, Christian, 82.  
Richard, 82.  
*Ward*, 150.  
Ward, Benedicta, 150.  
Elizabeth (Marshall), 166.  
Issabell, 117.  
Issabell (Seliok), 117.  
James, 166.  
John, 117.  
Simon, 150.  
*Wards*, 117.  
Warnby, Robertus de.  
Warner, William, 53.  
Warren, George, 72.  
Margarett (Molineux), 72.  
—, 112.  
Warwick, E. of [Beauchamp],  
49.  
Warwick, E. of [Rich], 18.  
*Wase*, 173.  
WASE, 173.  
Alice, 173.  
Alice (Bayly), 173.  
Anne, 173.  
Anne (Coulclough), 173.  
Dorathey, 173.  
Edward, 173.  
Elizabeth, 173.  
Elizabeth (Meverell), 173.  
Jane, 173.  
John, 173.  
Margarett, 173.  
Margery (Brookesby), 173.  
Richard, 173.  
Samson, 173.  
Thomas, 173.  
*Wastneys*, 68.  
WASTNEYS, 67, 68, 69.  
(including WASTNES).  
Anne, 42, 68, 69.  
Anne (Bassett), 68, 170.  
Bartholomew, 68.  
Daniell, 69.  
Elizabeth (Nelsonn), 68.  
Elizabeth (Blyth), 68.  
Florence (—♀—), 67.  
Geffrey, 68.  
George, 42, 68, 69, 170.  
Gervase, 68.  
Hardolph, 67, 69.  
Sir Hardolphe, 67, 69.  
Issabell (Lexborne), 67.  
Jane, 69.  
Jane (Delaboys), 69.  
Jane (Eyre), 69.  
Jane (Rerosby), 68.  
Joane, 67.  
John, 68, 69.  
Martha, 69.  
Mary (Melford), 68.  
Reginald, 67.  
Robert, 67, 68.  
Rosamond, 69.  
Silbell (—♀—), 67.  
Thomas, 67.  
William, 67.

WASTNEYS—*continued*.  
— (Bussie), 68.  
Waterman, *al's* Dixon, 28.  
Waterman, Richard, 28.  
Margaret (Trussell), 28.  
Waterton, Ann (Moton), 138.  
Jane, 139.  
Richard, 138, 139.  
Wats, Alice (Gate), 94.  
John, 94.  
Watson, Nicholas, 4.  
Watsonn, —, 115.  
Watton, Beatrice, 186.  
Sir William, 186.  
Watts, John, 94.  
Lucy, 94.  
Wayte, Jane (Reynes), 108.  
Thomas, 108.  
Webb, Ann (Draper), 137.  
Bennett (Draper), 137.  
Sir William, 137.  
Webster, Richard, 54.  
Henry, 3.  
Welbeck, Mary, 174.  
William, 174.  
Welby, Adelard, 96.  
Alice (White), 96.  
Elizabeth (White), 96.  
Henery, 96.  
Issabell, 154.  
Jane, 26.  
Wells, Catherin, 79.  
Catherin (Baker), 36.  
Cecily, 184.  
George, 36.  
John, 79.  
Lionell, Lord, 184.  
Welsh, Margery (Staunton), 9.  
Richard, 2.  
Thomas, 9.  
Wentworth, Anne, 40.  
Phillip, 40.  
Roger, 40.  
West, Catherin, 20.  
[Lord Delaware], 11, 20, 60,  
175.  
Mary, 60.  
William, 60.  
Weston, Alice, 34.  
Robert, 34.  
Wettenhall, —, 90.  
Weynman, Margarett, 16.  
Whaley, Elizabeth, 106.  
William, 106.  
*Whalley*, 105, 116, 117.  
WHALLEY, 116, 117, 118.  
Anne, 137.  
Anne (Horssey), 118.  
Edward, 118.  
Elizabeth, 118.  
Elizabeth (Strelley), 116.  
Elizabeth (Leek), 117.  
Elizabeth (Hatfeld), 118.  
Elizabeth (Howell), 118.  
Ellenor, 118.  
Frances, 118.  
Frances (Cromwell), 118.  
Henery, 118.  
Jane, 118.  
John, 116, 118.  
Judith, 118.  
Judith (Duffell), 118.

WHALLEY—*continued*.  
Lora (Brookman), 117.  
Margarett, 116, 118, 120.  
Margarett (Ireland), 118.  
Margeret (Mollineux), 116.  
Mary, 118.  
Mary (Midleton), 116, 118.  
Mary (Peniston), 118.  
Peniston, 118.  
Rebecka (Duffell), 118.  
Richard, 117, 118.  
Robert, 118.  
Scissely (Broughton), 116.  
Thomas, 116, 117, 118, 137.  
Ursulow, 116.  
Walter, 116, 118, 120.  
Wharton, Dorathey (Colby),  
149.  
Phillip Lord, 149.  
Robert, 4.  
*Whatton*, 190.  
Whatton, Sir Richard, 190.  
Whitby, Elizabeth (Moyle),  
174.  
Timothy, 174.  
*White*, 96, 189.  
WHITE, 96.  
Alice, 96.  
Anne, 96.  
Anne (Cicell), 96.  
Dorathey (Harper), 96.  
Elizabeth, 96.  
Ellenor (Marshall), 166.  
Gervase, 96.  
Sir John, 96.  
Marcye, 173.  
Nicholas, 96.  
Richard, 96.  
Robert, 16.  
Rosamond (Nevell), 65.  
Thomas, 65, 96, 166.  
Whitmore, Elizabeth, 103, 134.  
William, 134.  
*Whitworth*, 179.  
Whitworth, Athelin, 179.  
Widdew, Ann (Wase), 173.  
William, 173.  
Widdow, Ann (Hollis), 63.  
Sir John, 63.  
Widdowson, Lettice (Medhope),  
178.  
Richard, 178.  
*Widmerpoole*, 108.  
WIDMERPOOLE, 108.  
Anne, 108.  
Anne (Grunston), 108.  
Anne (Haselwood), 108.  
Dorathey (Danby), 108.  
Edmond, 108.  
Edward, 108.  
Francis, 108.  
George, 108.  
Henery, 108.  
Hugh, 108.  
Jane (Russell), 108.  
Joane, 108.  
John, 108.  
Joseph, 108.  
Margarett, 108.  
Mary, 108.  
Thomas, 108.  
William, 108.

*Widowson*, 96.  
 Widowson, Alice, 96.  
 Bartholomew, 96.  
*Wightman*, 113.  
 WIGHTMAN, 131, 132, 178.  
   Anne, 178.  
   Anne (Cooper), 132.  
   Catherin (Purefoy), 132, 178.  
   Edward, 132, 178.  
   Elizebeth, 178.  
   Elizebeth (Hacker), 132.  
   Elizebeth (Greene), 132.  
   Elizebeth (Wellington), 132.  
   Francis (Alford), 132.  
   George, 132.  
   James, 132.  
   Jane, 178.  
   Margarett (Starkey), 132.  
   Mary, 178.  
   Mary (Reynalds), 131.  
   Richard, 131, 132, 178.  
   Samwell, 132.  
   Scisseley (Wodam), 131.  
   Sibbell, 178.  
   Thomas, 131, 132, 178.  
   Vallentyne, 132, 178.  
   William, 131, 132.  
 Wigston, Elizabeth, 38.  
   Roger, 38.  
 Wikes, Joane, 137.  
   Walter, 137.  
 Wildbore, Jane (St. Andrew), 79.  
   Thomas, 79.  
 Wilkinson, Joane, 83.  
   Joane (North), 83.  
   William, 83.  
 William, Sir Richard, 4.  
 Williams, —, 164.  
*Williamson*, 97.  
 WILLIAMSON, 97, 98.  
   Anne, 97, 98.  
   Anne (Torkington), 97.  
   Anne (Marshall), 97.  
   Anne (Stockham), 97.  
   Anne (Disney), 97.  
   Barnaby, 97.  
   Catherin (Thornhill), 97.  
   Dorathey (Savell), 97.  
   Edmond, 98.  
   Elizabeth, 92, 98.  
   Elizabeth (Ryther), 97.  
   Frances, 98.  
   Frances (Bradford), 97.  
   Francis, 97.  
   Giles, 97.  
   Gresill (Overton), 98.  
   Gyles, 97.  
   Jane (Dobsonn), 98, 130.  
   Jane (Clerk), 98.  
   John, 97, 98, 130.  
   Magdalen, 98.  
   Margaret, 97.  
   Margaret (Thornhill), 97.  
   Mary, 98.  
   Mary (Andersonn), 98.  
   Sir Richard, 4, 98.  
   Robert, 92, 97.  
   Thomas, 98.  
   William, 97.  
*Willoughby*, 102, 145, 184.

WILLOUGHBY, 102, 145, 146, 147, 148, 149, 184, 185.  
 Abbigale, 149.  
 Alice, 148.  
 Anne, 102.  
 Anne (Wortley), 102.  
 Anne (Leek), 146.  
 Anne (Mortimer), 147.  
 Anne (Godfrey), 147.  
 Anne (Pettit), 147.  
 Anne (Percy), 148.  
 Anne (Grey), 148, 149.  
 Anne (Filliol), 148.  
 Baldwin, 147, 148.  
 Bridgett, 148, 149, 185.  
 Bridgett (Saunders), 147.  
 Bridgett (Rend), 148.  
 Bridgett (Willoughby), 149, 185.  
 Cassandra (Ridgway), 185.  
 Catherin, 147, 148, 185.  
 Catherin (Totlock), 146.  
 Catherin (Harte), 185.  
 Catherin (Goldwell), 185.  
 Cecily (Wells), 184.  
 Charles, 147.  
 Christopher, 184.  
 Sir Christopher, 184.  
 Dorathey, 148, 149.  
 Dorathey (Golby), 149.  
 Dorathey (Willoughby), 184.  
 Edward, 146, 147, 149, 185, 187.  
 Sir Edward, 145, 148.  
 Edmond, 146.  
 Sir Edmond, 145.  
 Elizabeth, 102, 146, 147, 148, 184, 185.  
 Elizabeth (Neale), 146.  
 Elizabeth (Knowles), 146.  
 Elizabeth (Chantrell), 147.  
 Elizabeth (Sheffield), 147.  
 Elizabeth (Merian), 147.  
 Elizabeth (Burgh), 148.  
 Elizabeth (Littleton), 149.  
 Elizabeth (Cooke), 185.  
 Ellenor, 147.  
 Ellener (— ? —), 147.  
 Ellen (Egerton), 148.  
 Francis, 87, 146, 148, 149, 185.  
 Sir Francis, 87, 149, 185.  
 Frances (Walkedyne), 102.  
 Frances (Hun), 146.  
 Friswold, 185.  
 George, 146, 147, 185.  
 Gilbert, 102.  
 Henery, 185.  
 Sir Henery, 20, 24, 146, 148, 149.  
 Hugh, 73, 121, 145, 146.  
 Sir Hugh, 22, 146, 148.  
 Issabell, 145.  
 Issabell (Mortein), 145.  
 Issabell (— ? —), 145.  
 Issabell (Annesley), 146.  
 Issabell (Foliambe), 146.  
 Issabell (Bradborne), 146.  
 Jane, 148, 149, 154.  
 Jane (Strelley), 22, 148.  
 Joane (Gray), 145.  
 Joane (Risley), 145.

WILLOUGHBY—*continued*.  
 John, 102, 146, 147, 187.  
 Sir John, 148.  
 Joyce, 147.  
 Kellom, 185.  
 Lettice, 185.  
 Margarett, 102, 146, 148, 149.  
 Margarett (Markham), 24, 148.  
 Margarett (Frevile), 146.  
 Margarett (Mollineux), 73, 146.  
 Margarett (Griffith), 147.  
 Margarett (Jenny), 184.  
 Mary, 102, 145, 147, 148, 184.  
 Mary (Newton), 148.  
 Mary (Tottishurst), 184.  
 Matilda (Stanhop), 6.  
 Mordaunt, 147.  
 Michell, 146.  
 Percivall, 149, 185.  
 Sir Percivall, 185.  
 Phillip, 148.  
 Phillippa, 138.  
 Ralphe, 147.  
 Richard, 145, 146, 147, 148.  
 Sir Richard, 20, 145.  
 Robert, 147, 148, 184, 185.  
 Sir Robert, 24, 154, 184.  
 Lord Robert, 6.  
 Roger, 145.  
 Sir Rotheram, 102.  
 Sanchia, 20.  
 Sara, 20.  
 Scisseley, 148.  
 Sence, 148.  
 Sibbell, 185.  
 Susan (Moulton), 102.  
 Thomas, 146, 147, 149, 185.  
 Sir Thomas, 184.  
 Wiborow (Daunsonn), 147.  
 Wiborow, 148.  
 Winifrid, 149.  
 Winifrid (Willoughby), 149, 185.  
 William, 102, 145, 148.  
 William, Lord, 184.  
 Ld. W. of Eresby, 184.  
 Ld. W. of Parham, 184.  
 [Ld. Cheefe Justice], 184.  
 — (Pewsey), 102.  
 — (Yong), 102.  
 — (Clifton), 146.  
 — (Wentworth), 146.  
 — (Sheppard), 147.  
 — (Pagett), 147.  
 Willowby, Edward, 187.  
 John, 187.  
 Wilson, — (Everingham), 41.  
 Wilton, Lord Gray of, 17.  
 Wimbreth, Christopher, 9.  
   Mary (Byrom), 9.  
 Windebank, Alice, 137.  
 Windesore, Walterus de, 53.  
 Windsor, Elizabeth, 158.  
*Wingfeld*, 169.  
 Wingfeld, Robert, 96.  
   Elizabeth (Cicell), 96.  
 Winalad, Jane (Babington), 152.  
   William, 152.  
 Winsley, Francis (Yerburgh), 106.  
   Thomas, 106.

- Witeby, Alexandrus de, 79.  
 Witham, Mary, 94.  
 Withcott, Sir Hamond, 26.  
   Millicent (Markham), 26.  
 Withepoole, Edmond, 162.  
   Frances (Cornwallis), 162.  
 Witherington, Dr., 177.  
   Sara (Barnard), 177.  
*Wodam*, 131.  
 Wolam, Alice (Trussell), 131.  
   Scisseley, 131.  
   Thomas, 131.  
 Woderoff, Bridgett (Draper),  
   137.  
   Stephen, 137.  
*Wodesonn*, 190.  
 Wofull, Ellena, 7.  
   Robert, 7.  
*Wollaton*, 169.  
 Wollhouse, Margt. (Baker), 36.  
*Wood*, 86.  
 WOOD, 86, 87, 88.  
   Anne, 88, 187.  
   Anne (Aungell), 88.  
   Charles, 91.  
   Catherin (Hudson), 87.  
   Catherin (Chaworth), 88,  
     128.  
   Dorathey, 88.  
   Edward, 87.  
   Edmond, 88.  
   Elizabeth, 86, 88, 91.  
   Elizabeth (Slory), 87.  
   Elizabeth (Thornhill), 87.  
   Elizabeth (Willoughby), 148.  
   Frances, 88.  
   Francis, 88.  
   Francis (Willoughby), 87,  
     149.  
   George, 88.  
   Gerrard, 88.  
   Gervase, 88.  
   Grace, 88.  
   Henery, 86.  
   Hugh, 187.  
   Issabell, 87.  
   James, 88.  
   Jane (Strelley), 86.  
   John, 87, 88, 128, 183.  
   Margarett (Montague), 87.  
   Margarett, 87, 183.  
   Mary, 87, 88.  
   Mary (Baron *al's* Barnes), 88.  
   Mary (Lyn), 88.  
   Mary (Phettiplace), 88.  
   Mountague, 87, 149.  
   Phillip, 88.  
   Robert [Delwood], 87.  
     " [Note], 87.
- Woods—*continued*.  
   Robert, 87, 88.  
   Roger, 88.  
   Simon, 88.  
   Thomas, 88.  
   Sir Thomas, 86.  
     — (Delamare), 38, 86.  
 Wooddes, —, 85.  
 Wooderington, Issabell, 58.  
   Sir —, 58.  
 Woodford, —, 65.  
 Woodnoth, Laurence, 131.  
   Margery, 131.  
 Wooton, Edmond, 184.  
   Dorathey (Read), 184.  
   Lord, 184.  
     — (Hollis), 62.  
 [Worcester, Bp. of], 18.  
 Worteley, Anne, 102.  
   Nicholas de, 47.  
   Richard, 102.  
 Woston, —, 8.  
 Wotton, Roger de, 46.  
 Wray, Dorathey, 82.  
   Thomas, 82.  
 Wright, Ellenor (Clarkson),  
   92, 183.  
 Wyatt, Anne, 174.  
 Wykes, Elizabeth (Babing-  
   ton), 152.  
   John, 152.  
*Wylde*, 187.  
 Wylde, Ellen (Stanton), 181.  
   William, 181.  
*Wymondeswold*, 114.  
 WYMONDESWOLD, 114.  
   Agnes (Leeke), 114.  
   Anne (Billingay), 114.  
   Edmond, 114.  
   Edward, 114.  
   Frances, 114.  
   Joane, 114.  
   John, 114.  
   Leonard, 114.  
   Mary, 114.  
     — (Hall), 114.  
 Wymondham, Elizabeth, 136.
- Yarborough, Barbara, 101.  
   Charles, 101.  
*Yerburgh*, 105.  
 YERBURGH, 105, 106.  
   Agnes (Skipwith), 106.  
   Anne, 106.  
   Anne (Staine), 105.  
   Barbara, 106.  
   Beatrix (Auk), 105.  
   Bridgett, 106.  
   Bryan, 106.
- YERBURGH—*continued*.  
   Cassandra (Mablethorpe),  
     105.  
   Charles, 106.  
   Christopher, 106.  
   Edmond, 106.  
   Elizabeth, 106.  
   Elizabeth (Moynes), 106.  
   Elizabeth (Newcomen), 106.  
   Elizabeth (Litlebery), 106.  
   Elizabeth (Whaley), 106.  
   Ellenor (Clifford), 106.  
   Eustace, 105.  
   Fayth, 106.  
   Francis, 106.  
   Hercye, 106.  
   Issabell (Orby), 105.  
   Issabell (Billing), 106.  
   Joane, 106.  
   Joane (Attwell), 106.  
   John, 105, 106.  
   Lambert, 105.  
   Margarett, 106.  
   Margarett (Portington), 106.  
     " (Bovington), 106.  
   Margarett (Grantham), 106.  
   Mary (Elwis), 29.  
   Mary, 106.  
   Maude (Mumby), 106.  
   Peter, 106.  
   Raffe, 105.  
   Richard, 105, 106.  
   Robert, 29, 105.  
   Theodocia, 106.  
   Thomas, 106.  
   Ursula (Homberston), 106.  
   Ursula (Wall), 106.  
   William, 105, 106.  
   Wimifrid, 106.  
     — (Ormesby), 105.  
     — (Bissam), 105.  
     — (Angevine), 105.  
     — (Michell), 106.  
 Yetsworth, Mary, 26.  
 Nicasus, 26.  
 Yong, Anne (Moyle), 174.  
   —, 102.
- Zouch*, 145.  
 Zouch, Edward, Lord, 84.  
   Elizabeth, 84, 160.  
   Sir John, 148, 160.  
   Julian, 78.  
   Margarett (Burgh), 160.  
   Margarett (Willoughby), 148.  
   Robert, 78.  
   William, Lord, 160.  
*Zouche*, 160.



# The Harleian Society,

INSTITUTED FOR THE

PUBLICATION OF INEDITED MANUSCRIPTS

RELATING TO

GENEALOGY, FAMILY HISTORY, AND HERALDRY.

---

## President.

HIS GRACE THE DUKE OF MANCHESTER.

## Vice-Presidents.

THE RIGHT HON. VISCOUNT MIDLETON.  
THE RIGHT HON. LORD MONSON.  
THE HON. HENRY ROPER-CURZON.  
SIR GEORGE F. DUCKETT, BART., F.S.A.  
SIR HENRY M. VAVASOUR, BART.  
SIR JOSEPH RADCLIFFE, BART.  
RALPH ASSHETON, Esq., M.P.  
EVELYN PHILIP SHIRLEY, Esq., F.S.A.  
R. E. EGERTON-WARBURTON, Esq.

## Council.

JOSEPH JACKSON HOWARD, Esq., LL.D., F.S.A., *Hon. Treasurer.*  
THE REV. SAMUEL HAYMAN, M.A.  
GEORGE J. ARMYTAGE, Esq., F.S.A., *Hon. Secretary.*  
COLONEL JOSEPH LEMUEL CHESTER.  
JOHN DAVIDSON, Esq.  
SIR JOHN MACLEAN, F.S.A.  
WENTWORTH STURGEON, Esq.  
JOHN FETHERSTON, Esq., F.S.A.  
FAIRLESS BARBER, Esq., F.S.A.  
W. AMHURST TYSSEN AMHURST, Esq., F.S.A.  
GEORGE W. MARSHALL, Esq., LL.M.  
GRANVILLE LEVESON GOWER, Esq., F.S.A.

## Bankers.

LONDON AND COUNTY, 21, Lombard Street.

## Auditors.

J. R. DANIEL TYSSEN, Esq., F.S.A., 9, Lower Rock Gardens,  
Brighton.  
DUDLEY CARY ELWES, Esq., F.S.A., South Bersted, Bognor.

## Rules.

1. This Society shall be called the HARLEIAN SOCIETY.
2. It shall have for its chief object the publication of the Heraldic Visitations of Counties, and any manuscripts relating to genealogy, family history, and heraldry, selected by the Council.
3. The Council shall consist of a President, nine Vice-Presidents, and twelve Members of Council, two of whom shall hold the posts of Secretary and Treasurer; and any four, including the Treasurer or Secretary, shall form a quorum. In case of equality of votes, the Chairman to have a casting vote. Any Candidate may be elected with the consent in writing of one Member of the Council, the Treasurer, and the Secretary.
4. Three Members of the Council shall retire in rotation annually but shall be eligible for re-election.
5. The Annual Subscription shall be One Guinea, paid in advance, and due on the 1st day of January in each year; and Members elected after two hundred and fifty shall have joined, shall pay an Entrance Fee of 10s. 6d. in addition to their first Annual Subscription.
6. The funds raised by the Society shall be expended in publishing such works as are selected by the Council.
7. One volume at least shall be supplied to the Members every year.
8. An Annual Meeting shall be held in the month of June every year, at such time and place as the Council may direct; and due notice shall be sent to the Members of the Society at least a fortnight previously.
9. No work shall be supplied to any Member unless his Subscription for the year be paid; and any member not having paid his subscription for two years, having received notice thereof, shall cease to belong to the Society.
10. The Council may, at their discretion, pay the expense of transcribing from manuscripts whenever two hundred Members, at least, shall have joined the Society; but no payment in money shall be made to any person for editing any work for the Society.
11. No copies of the Publications of the Society shall be supplied to persons not actually Members, and each Member shall be restricted to a single Subscription.
12. An account of the receipts and expenses of the Society to be made up to the 1st of June in each year, and published with a list of the Members and the Rules of the Society in the following volume.
13. These Rules shall not be altered except at the Annual Meeting, and three clear weeks' notice must be given to the Secretary of any such intended alteration.

---

*The Council has selected the Visitations of Oxford in 1574 and 1634 to follow that of Rutland, and the Visitation of Nottingham in 1614 to follow those of Oxford.*

## Report for the Year 1870-71.

THE Council has to call the special attention of Members to the Society's progress during the past year.

One hundred and seventy Members had joined the Society in May, 1870, and since then this number has been augmented by nearly one hundred Members, the total being now two hundred and sixty-seven.

From the Society's formation to the present time, only one Member has withdrawn, two are dead—Colonel BRADBURY and Rev. DAWSON DUFFIELD, Rector of Sephton,—one name has been struck off from the list in consequence of no Subscription having been paid, and two subscribed for the purpose of obtaining the 'Leicester Visitation' only.

Since the last Report the Society has published 'The Visitation of Leicestershire in 1619,' by LENNARD and VINCENT, edited by JOHN FETHERSTON, jun., Esq., F.S.A., and the 'Visitation of Rutland in 1618,' edited by the Honorary Secretary.

There are in the press at the present time 'The Visitation of Oxford in 1574 and 1634,' edited by W. H. TURNER, Esq. and 'The Visitation of Nottingham in 1614,' edited by G. W. MARSHALL, Esq., LL.M. These works will shortly be ready for distribution.

The 'Visitation of Devon,' to be edited by the Rev. F. T. COLBY, F.S.A., will at once be proceeded with, and it is hoped that this Work will be ready for distribution early next year.

Since the last Report an arrangement has been made with the Surrey Archæological Society for the use of a room at 8, Danes Inn, for meeting, by payment of five pounds a year.

The Balance-Sheet is appended for the inspection of Members, and it is hoped that the expenditure may be considered satisfactory.

The Council desire to impress upon the Members the necessity of paying their Subscriptions in advance, and of making the Society known among their literary friends. Copies of Prospectuses and Forms of Application for Membership can always be obtained by applying to the Honorary Secretary or to Mr. SMALLFIELD, 10, Little Queen Street, High Holborn, W.C.

The Subscriptions should be remitted to the Honorary Treasurer, 8, Dartmouth Row, Blackheath.

# Parliamentary Society.

## BALANCE SHEET FOR THE YEAR ENDING 31st MAY, 1871.

<i>Dr.</i>	<i>£.</i>	<i>s.</i>	<i>d.</i>	<i>Cr.</i>	<i>£.</i>	<i>s.</i>	<i>d.</i>
Balance brought forward . . . . .			88 10 1	Messrs. Taylor and Co., for Printing Leicester and Rutland Visitations, { 184 11 0			
Subscriptions, etc., 1869 . . . . .		63	0 0	Binding, Circulars, etc. . . . .	50	8 0	
" 1870 . . . . .		220	13 6	284 19 0			
" 1871 . . . . .		229	17 0	Advertisements . . . . .			0 4 0
Entrance Fees . . . . .		6	4 6	1 1 0			
Donation . . . . .		1	1 0	1 1 0			
			519 16 0	Return of Subscription previously paid . . . . .			1 1 0
			£608 6 1	Incidental Expenses—			
				Honorary Treasurer . . . . .	2	12	6
				2	3	0	
				4	15	6	
				Honorary Secretary . . . . .	1	14	5
				5	3	7	
				6	18	0	
Examined and found correct. Vouchers furnished in support of the various payments.				Balance in hand on 31st May, 1871 . . . . .			248 18 6
							359 7 7
							£608 6 1

LIONEL G. ROBINSON, } *Hon. Auditors.*  
 DUDLEY CARY-ELWES, }

*June 9, 1871.*

J. J. HOWARD, *Hon. Treasurer.*

*June 2, 1871.*

## List of Members,

CORRECTED TO OCTOBER 20, 1871.

- G. BRINDLEY ACWORTH, F.S.A., Star Hill, Rochester.  
 EDWARD AKROYD, M.P., F.S.A., Bank Field, Halifax.  
 REGINALD AMES, Cote House, Westbury-on-Trym, Bristol.  
 W. AMHURST T. AMHURST, F.S.A. (*Council*), Didlington Hall, Brandon.  
 FRANK ANDREW, Apsley Place, Ashton-under-Lyne.  
 ELY ANDREW, Mere Bank, Ashton-under-Lyne.  
 J. E. ANDREWES, War Office.  
 CHARLES FREDERICK ANGELL, F.S.A., Grove Lane, Camberwell, S.E.  
 THE SOCIETY OF ANTIQUARIES OF LONDON, Somerset House, W.C.  
 WILLIAM SUMNER APPLETON, Boston, U.S.A.  
 FRANCIS R. ARMYTAGE, Balliol College, Oxford.  
 GEORGE J. ARMYTAGE, F.S.A. (*Hon. Secretary*), Clifton, Brighouse.  
 THE EARL OF ARRAN, The Pavilion, Hans Place, S.W.  
 RALPH ASHSTON, M.P. (*Vice-President*), Downham Hall, Clitheroe.  
 JOHN ASTLEY, Broad Gate, Coventry.  
 The Rev. CHARLES S. ATKINSON, Harswell, York.  
 W. J. ST. AUBYN, 68th Light Infantry, Fort Camden, Cork.  
 ROBERT A. C. GODWIN-AUSTEN, Chilworth Manor, Guildford.
- Lieut.-Colonel BAGNALL, Shenstone Moss, near Lichfield.  
 CHARLES BAKER, F.S.A., 11, Sackville Street, Piccadilly, W.  
 MRS. BAKER, Ulster Terrace, Regent's Park, N.W.  
 FAIRLESS BARBER, F.S.A. (*Council*), Castle Hill, Rastrick, near Brighouse.  
 JOSEPH GURNEY BARCLAY, 54, Lombard Street, E.C.  
 THOMAS H. BATES, Mayfield, Wolsingham.  
 JOHN BATTEN, F.S.A., Aldon, Yeovil.  
 FRANCIS BAYLEY, 66, Cambridge Terrace, Hyde Park, W.  
 GEORGE FREDERICK BRAUMONT, The Knowles, Fixby, Huddersfield.  
 THE BIRMINGHAM LIBRARY, Union Street, Birmingham.  
 T. WELD-BLUNDELL, Ince Blundell Hall, Great Crosby, Liverpool.  
 The Rev. CHARLES W. BOASE, 33, Surrey Street, Strand, W.C.  
 WILLIAM EDWARD BOOLS, 7, Cornhill, E.C.  
 THOMAS WILLIAM BOORD, F.S.A., 180, Belsize Road, Kilburn, N.W.  
 Lieut.-Colonel HAWORTH-BOOTH, Derwent Bank, Malton, Yorkshire.  
 W. CONNITT BOULTER, F.S.A., 6, Park Row, Park Street, Hull.  
 Lieut.-Colonel JOHN BUTLER-BOWDEN, Pleasington Hall, Blackburn.  
 EDMUND M. BOYLE, Rockwood, Torquay.  
 CHARLES HOLTE BRACEBRIDGE, The Hall, Atherstone, Warwickshire.  
 The Rev. WILLIAM BREE, the Rectory, Allesley, Coventry.  
 The Hon. and Rev. JOHN R. O. BRIDGEMAN, Weston-under-Lyziard, Shifnal.  
 THOMAS BROOKE, Armitage Bridge, Huddersfield.  
 FRANCIS CAPPER BROOKE, Ufford Place, Woodbridge.  
 The Rev. FREDERICK BROWN, F.S.A., Fern Bank, Beckenham, Kent.  
 PERCY C. S. BRUCE, Middleham, Bedale, Yorkshire.  
 C. G. PRIDEAUX BRUNE, Prideaux Place, Padstow, Cornwall.  
 The Rev. JOSEPH BUCKLEY, M.A., Sopworth Rectory, Chippenham.  
 Captain W. E. G. LYTTON BULWER, Quebec House, East Dereham.  
 JOHN YNYR BURGESS, Parkanaur, Dungannon, Tyrone, Ireland.  
 CHARLES JOHN BURGESS, Naval and Military Club, London, W.  
 SIR BERNARD BURKE, C.B., LL.D., Ulster King-of-Arms, Dublin.  
 The MARQUIS OF BUTE, 83, Eccleston Square, S.W.
- BENJAMIN BOND CABELL, F.R.S., F.S.A., 52, Portland Place, W.  
 F. TEAGUE CANRICK, 28, Jeffrey Street, Kentish Town, N.W.

- R. BROWN CANSICK, 2, Bedford Gardens, Kensington, W.  
 The Dowager Countess of Carnarvon, Pixton Park, Dulverton.  
 GEORGE ALFRED CARTHEW, F.S.A., East Dereham, Norfolk.  
 THOMAS CHAPMAN, F.R.S., F.S.A., 25, Bryanstone Square, W.  
 CHRISTOPHER CHATCOCK, Hays House, Castle Bromwich.  
 Colonel J. L. CHESTER (*Council*), 16, Linden Villas, Blue Anchor Road, Bermondsey, S.E.  
 CHETHAM'S LIBRARY, Manchester (Thomas Jones, Esq., Librarian).  
 SIR ALEXANDER P. BRUCE CHICHESTER, Bart., Arlington Court, Barnstaple.  
 THOMAS CLOSE, F.S.A., Nottingham.  
 The Rev. RICHARD CHUTE CODRINGTON, Haygrove, Bridgewater, Somerset.  
 The Rev. FREDERIC T. COLBY, B.D., F.S.A., Fellow of Exeter College, Oxford.  
 JAMES EDWIN COLE, Easthorpe Court, Wigtoft, Spalding.  
 F. S. BIRMINGHAM PEN COLE, Freemantle, Southampton.  
 SYDNEY COLE, Norwood Court, Southall, Middlesex.  
 JAMES COLEMAN, 22, High Street, Bloomsbury, W.C.  
 J. KYRLE COLLINS, Wiltondale, Ross, Herefordshire.  
 WM. HENRY COOKE, Esq., Q.C., F.S.A., 42, Wimpole Street, London.  
 W. H. COTTELL, 1, Manor Rise, Brixton, S.W.  
 J. GREGORY COTTINGHAM, Edensor, Chesterfield.  
 W. PRIDEAUX COURTNEY, Ecclesiastical Commission.  
 The Rev. H. O. COXE, Bodleian Library, Oxford.  
 Mrs. JOHN WOODHEAD CROSLAND, Thornton Lodge, Huddersfield.  
 EDWIN PURVES ROPER-CURZON, Upper Sheen House, Mortlake, S.W.  
 The Hon. HENRY ROPER-CURZON (*Vice-President*), 47, Argyle Road, Kensington.  
 The Hon. SIDNEY C. ROPER-CURZON, Upper Sheen House, Mortlake, S.W.
- R. S. LONGWORTH DAMES, M.A., 32, Upper Mount Street, Dublin.  
 C. W. DAVID, Cardiff, Glamorganshire.  
 JOHN DAVIDSON (*Council*), 14, St. George's Place, Hyde Park Corner, S.W.  
 ROBERT DAVIES, F.S.A., The Mount, York.  
 ROBERT DAY, JUN., F.S.A., M.R.I.A., Rockview, Montenotte, Cork.  
 GORDON DAYMAN, St. Giles's, Oxford.  
 The Rev. JOHN BATHURST DEANE, M.A., F.S.A., Sion Hill, Bath.  
 GEORGE DIGBY WINGFIELD DIGBY, Sherborne Castle, Sherborne, Dorsetshire.  
 Mrs. FETHERSTON DILKE, Maxstoke Castle, Coleshill, Warwickshire.  
 Sir C. WENTWORTH DILKE, Bart., M.P., 76, Sloane Street, W.  
 ROBERT DOWMAN, 'Manchester Guardian' Office, Manchester.  
 HENRY HOLMAN DRAKE, LL.D., Esplanade, Fowey, Cornwall.  
 Sir GEORGE F. DUCKETT, Bart., F.S.A. (*Vice-President*), Sydling Court, Dorchester.  
 GEORGE F. DUNCOMBE, 17, St. Stephen's Road, Bayswater, W.
- CHARLES EDMUNDS, Bull Street, Birmingham.  
 ALBERT EDWARDS, Philadelphia, U.S.A.  
 J. EDWARDS, M.D., 20, Westmoreland Place, Bayswater, W.  
 The Rev. HENRY T. ELLACOMBE, M.A., F.S.A., Clyst St. George Rectory, Topsham, Devon.  
 WILLIAM SMITH ELLIS, Hydecroft, Charlwood, Surrey.  
 DUDLEY CARY ELWES, F.S.A., South Bersted, Bognor.  
 V. CARY ELWES, F.S.A., Brigg, Lincolnshire.  
 WILLIAM ROBERT EMERIS, M.A., F.S.A., Louth, Lincolnshire.
- THOMAS FALCONER, one of the Judges of the County Courts, Usk, Monmouthshire.  
 J. G. FANSHAWE, Board of Trade, Whitehall, S.W.  
 WILLIAM FENNELL, Wakefield.  
 ROBERT FERGUSON, F.S.A., Morton Hall, Carlisle.  
 JOHN FETHERSTON, jun., F.S.A. (*Council*), High Street, Warwick.  
 Lady FETHERSTONHAUGH, Uppark, Petersfield.  
 W. S. FETHERSTONHAUGH, Rock View, Killucan, Ireland.  
 GEORGE FITZWILLIAMS, New York, U.S.A.  
 EDWARD FITZWILLIAMS, Philadelphia, U.S.A.  
 WILLIAM FLOYD, London Institution, Finsbury Circus, E.C.

CHARLES H. FOX, M.D., The Booches, Brislington, Bristol.

CLEMENT S. BEST-GARDNER, Eagle's Bush, Neath, Swansea.  
 JOHN RIBTON GARSTIN, F.S.A., 21, Upper Merrion Street, Dublin.  
 ARTHUR EDWARD GAYBE, Q.C., LL.D., Dublin.  
 HENRY H. GIBBS, St. Dunstan's, Regent's Park, N.W.  
 JOSEPH GILLOW, jun., Winckley Square, Preston.  
 C. GOLDING, 16, Blomfield Terrace, Upper Westbourne Terrace, W.  
 HENRY GOUGH, 20, Loti Road, Brixton, S.W.  
 GRANVILLE LEVESON GOWER, F.S.A. (*Council*), Titsey Park, Godstone.  
 HENRY SYDNEY GRAZERBROOK, Stourbridge, Worcestershire.  
 EDWARD GRAVES, M.P., Avonside, Warwick.  
 BENJAMIN WYATT GREENFIELD, Cranbury Terrace, Southampton.  
 KELYNOR GREENWAY, Warwick.  
 Captain HOOD GREGORY, Styvechale Hall, Coventry.  
 The Rev. WILLIAM GRICE, Sherborne House, Lillington, Leamington.  
 The Rev. HENRY THOMAS GRIFFITH, B.A., Felmingham Vicarage, Norwich.  
 THOMAS GRISSELL, F.S.A., F.R.S.L., Norbury Park, Mickleham, Dorking.  
 GORDON GYLL, Remenham House, Wraysbury, Staines.  
 EDWARD HAILSTONE, F.S.A., Walton Hall, Wakefield.  
 Sir HENRY ST. JOHN HALFORD, Bart., Wistow, Leicestershire.  
 The Rev. H. F. HALL, M.A., High Legh, Knutsford, Cheshire.  
 Sir ROBERT N. C. HAMILTON, Bart., Avoncliffe, Stratford-on-Avon.  
 Lady FRANCES VERNON-HARCOURT, The Homme, Weobly.  
 JOHN HARDY, M.P., Dunstall Hall, Burton-on-Trent.  
 WILLIAM HENRY HART, F.S.A., The White House, St. Peter's Lane, Canterbury.  
 WILLIAM HARVEY, Hatfold Hall, Bedford.  
 The Rev. HENRY HAYMAN, D.D., The School, Rugby.  
 The Rev. SAMUEL HAYMAN, M.A. (*Council*), The Rectory, Doneraile, Ireland.  
 Lady HEATHCOTE, Hursley Park, Winchester.  
 C. PELL HEIGHAM, The Cottage, Bambridge, Winchester.  
 THOMAS HELSBY, 41, Princess Street, Manchester.  
 SPENCER HEREPATH, 18, Upper Phillimore Gardens, W.  
 WILLIAM PERRY HERRICK, Beaumanor Park, Loughborough, Leicestershire.  
 Miss FRANCIS MARGERY HEXT, Lostwithiel, Cornwall.  
 JOHN HIRST, jun., Dobcross, Saddleworth.  
 The Rev. C. W. HOLBECH, Farnborough, Banbury.  
 DANIEL DEAN HOPKYN, F.S.A., Weycliffe, St. Catherine's, near Guildford.  
 CHANDOS WREN HOSKYN, Esq., M.P., Harewood House, Ross, Herefordshire.  
 JOSEPH JACKSON HOWARD, LL.D., F.S.A. (*Hon. Treas.*), 3, Dartmouth Row,  
 Blackheath, S.E.  
 THOMAS HUGHES, F.S.A., 1, Grove Terrace, Chester.

The ROYAL IRISH ACADEMY, 19, Dawson Street, Dublin.

The Rev. EDMUND JERMYN, B.A., Barking Vicarage, Essex.  
 JOSEPH JONES, Abberley Hall, Stourport.  
 MORRIS C. JONES, F.S.A., 20, Abercromby Square, Liverpool.  
 W. STAVENHAGEN JONES, 2, Verulam Buildings, Gray's Inn, W.C.  
 EDWARD BASIL JUPP, F.S.A., Carpenters' Hall, London Wall, E.C.

The Rev. F. W. KITTERMASTER, All Saints, Coventry.  
 ARTHUR JOHN KNAPP, Llanforsh House, Clifton, Bristol.  
 T. C. SNEYD KYNNEBLY, Moor Green, Moseley, Birmingham.

Lieut.-Colonel J. H. BAGOT LANE, King's Bromley Manor, Lichfield.  
 C. T. LANE, 3, Lombard Court, Lombard Street, E.C.  
 PHILIP LANGMAN, 7, St. Benet's Place, Gracechurch Street.  
 THOMAS LAYTON, F.S.A., Kew Bridge, Middlesex, W.  
 Sir EDMUND A. LECHMERE, Bart., The Rhydd Court, Upton-on-Severn,  
 Worcester.

The Rev. F. G. LEE, D.C.L., F.S.A., 6, Lambeth Terrace, S.W.  
 MRS. LITLEDALE, 19, Queen's Gate Gardens, South Kensington.  
 BEN. LOCKWOOD, Huddersfield.  
 The Rev. W. J. LOFTIE, 37, Upper Berkeley Street, W.  
 WILLIAM H. DYER LONGSTAPPE, F.S.A., Gateshead.

Sir JOHN MACLEAN, F.S.A. (*Council*), Pallingswick Lodge, Hammersmith, W.  
 SILVANUS J. MACY, 189, Front Street, New York, U.S.A.  
 The Rev. A. R. MADDISON, Friskney, Boston, Lincolnshire.  
 C. H. MALLOCK, Cockington Court, Torquay.  
 The DUKE OF MANCHESTER (*President*), 1, Great Stanhope Street, W.  
 GEORGE W. MARSHALL, LL.M. (*Council*), Weacombe House, Bicknoller, Taunton.  
 BERNULF DE CLEGG MATTINSON, Oldham.  
 WALTER C. METCALFE, Epping, Essex.  
 The Right Hon. VISCOUNT MIDDLETON, Peper Harrow Park, Godalming.  
 Lieut.-Colonel MILLER, R.A., Woolwich, S.E.  
 MINNESOTA HISTORICAL SOCIETY, St. Paul, Minnesota, U.S.A.  
 The Rev. JOHN MIREHOUSE, Colsterworth, Grantham.  
 Captain R. MOLESWORTH, High Legh, Knutsford.  
 The Right Hon. LORD MONSON (*Vice-President*), Gatton Park, Reigate.  
 THOMAS H. MONTGOMERY, 400, Walnut Street, Philadelphia, U.S.A.  
 Lieut.-Col. CHARLES THOMAS JOHN MOORE, F.S.A., Frampton Hall, near Boston.  
 FREDERICK J. MORRELL, St. Giles', Oxford.  
 EDWARD MORTON, F.S.A., The Bank, Malton, Yorkshire.  
 GEORGE J. MURRAY, Hartford House, Werneth, Oldham.  
 C. R. SCOTT-MURRAY, Danesfield, Great Marlow.

C. N. NEWDEGATE, M.P., Arbury Hall, Nuneaton, Warwickshire.  
 Miss NEWMAN, 6, Patshull Road, Kentish Town, N.W.  
 Miss CHARLOTTE NEWMAN, 6, Patshull Road, Kentish Town, N.W.  
 JAMES NEWMAN, 235, High Holborn, W.C.  
 Captain W. NEWSOME, R.E., Gravesend.  
 J. W. NICHOLL-CARNE, D.C.L., St. Donat's Castle, Bridgend, Glamorganshire.  
 JOHN GOUGH NICHOLS, F.S.A., 25, Parliament Street, S.W.  
 Colonel SIDNEY NORTH, M.P., Wroxton Abbey, Banbury.  
 WILLIAM NOY, 38, Sutherland Square, S.E.

WILLIAM JOHN O'DONNAN, LL.D., M.R.I.A., Foxcroft House, Portarlington.  
 EVAN ORTNER, 3, St. James's Street, S.W.  
 FREDERIC OUVRY, F.S.A., 12, Queen Anne Street, Cavendish Square.

The Rev. THOMAS DOUGLAS PAGE, Pembroke College, Oxford.  
 Sir CHARLES J. PALMER, Bart., Doiney Court, Windsor.  
 The Rev. FIELDING PALMER, Eastcliff, Cheltenham.  
 The Rev. GEORGE PALMER, F.S.A., 53, Lowndes Square, S.W.  
 The Rev. JOHN PAPILLON, M.A., F.S.A., Lexdon Rectory, Colchester.  
 The Rev. J. T. PARKINSON, D.C.L., F.S.A., Ravendale, Grimsby.  
 DANIEL PARSONS, Stuarts Lodge, Malvern.  
 D. WILLIAMS PATERSON, Newark Valley, New York, U.S.A.  
 EDWARD PEACOCK, F.S.A., Bottesford Manor, Brigg, Lincolnshire.  
 Rev. A. J. PEARMAN, Rainham Vicarage, Sittingbourne.  
 CHARLES GEORGE PERCEVAL, Passenheim Manor, Stony Stratford.  
 IRA B. PECK, Woonsocket, Rhode Island, U.S.A.  
 HENRY PECKETT, Carlton Husthwaite, Thirsk, Yorkshire.  
 THOMAS A. PERRY, Bitham House, Leamington.  
 JOSEPH PLUCKNETT, F.S.A., Manor House, Finchley, N.  
 LEMUEL POPE, Concord, Massachusetts, U.S.A.

Sir JOSEPH RADCLIFFE, Bart. (*Vice-President*), Rudding Park, Wetherby.  
 The Rev. CANON RAINE, York.  
 J. R. RAINES, Burton Pidsea, Hull.  
 SAMUEL RIGBY, Bruch Hall, Warrington.  
 ALEXANDER RIVINGTON, 27, Cleveland Gardens, Hyde Park, W.



